

AT THE
FRONT

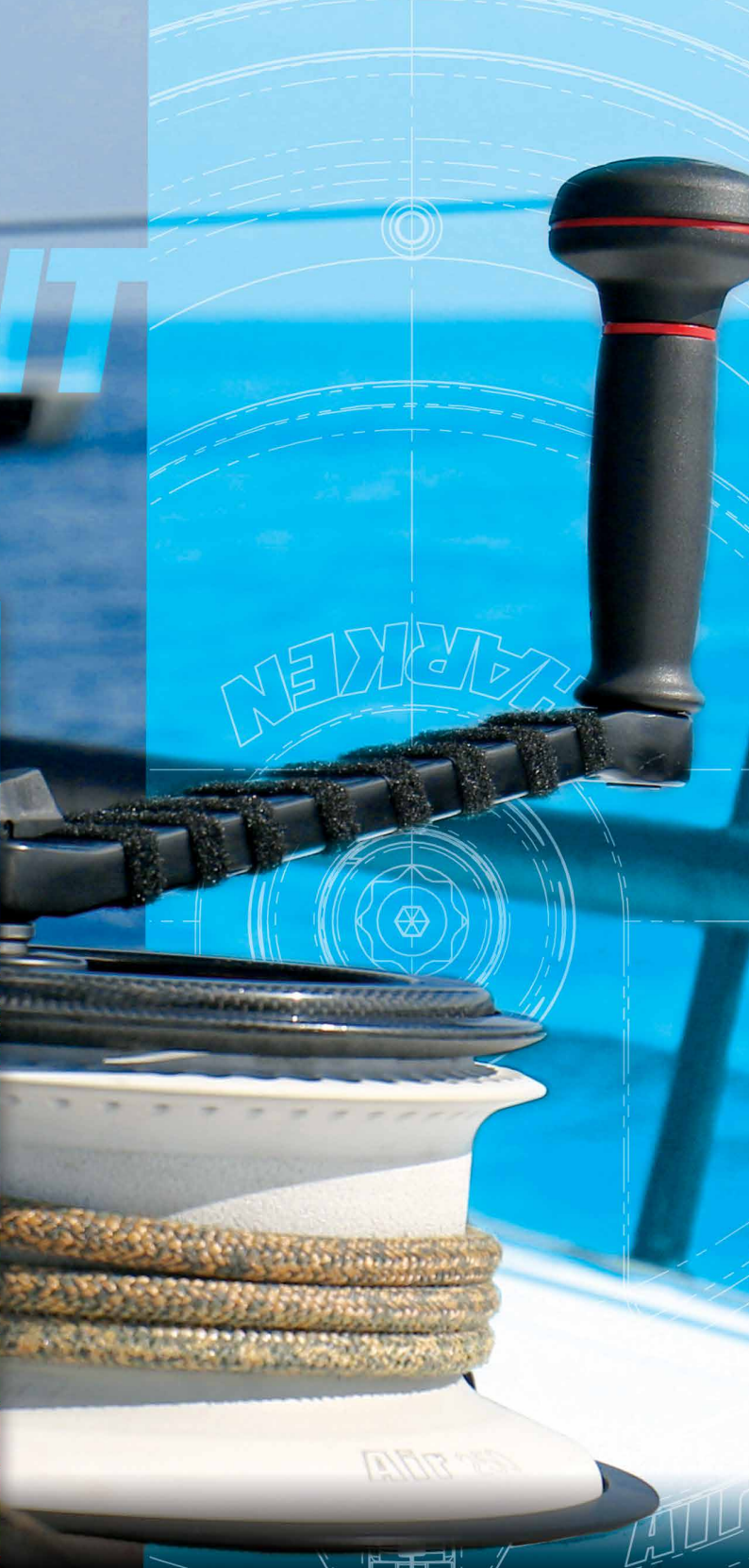

HARKEN®

2024 CATALOG

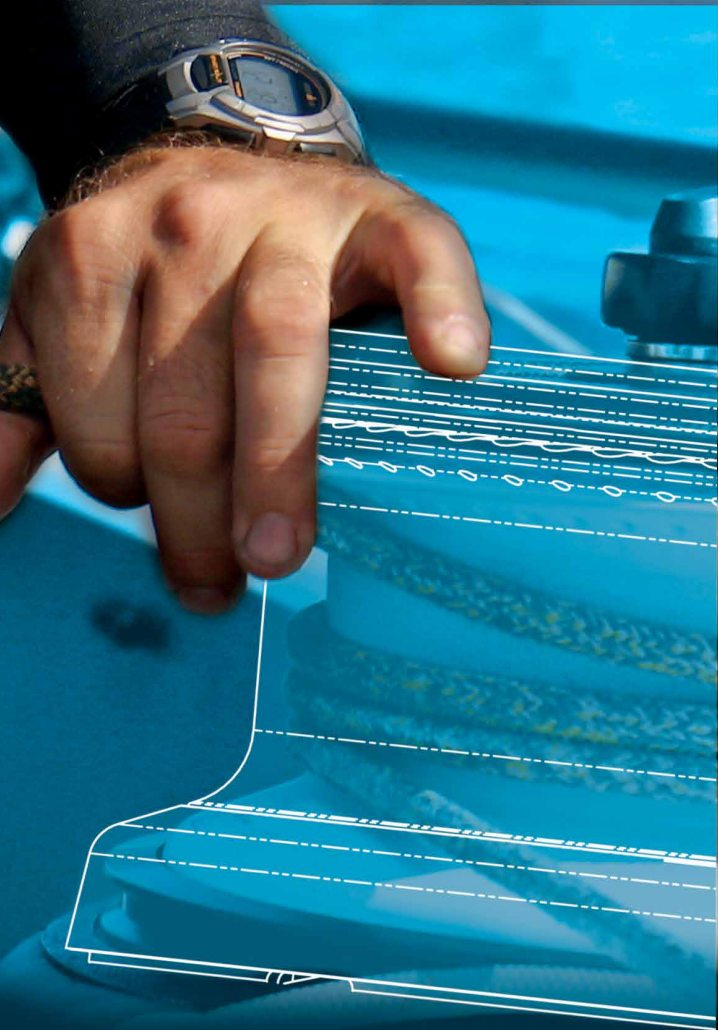
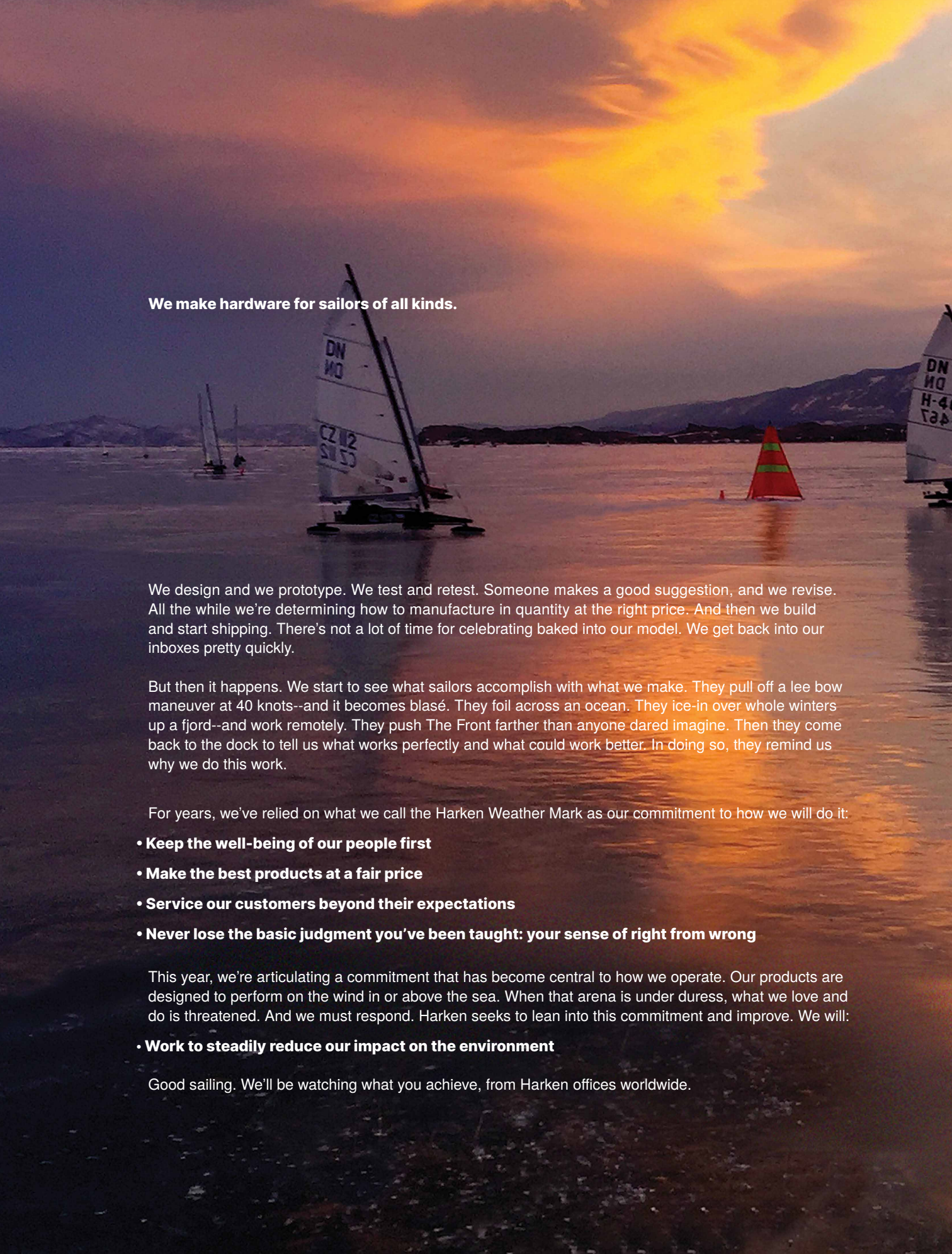

We make hardware for sailors of all kinds.

We design and we prototype. We test and retest. Someone makes a good suggestion, and we revise. All the while we're determining how to manufacture in quantity at the right price. And then we build and start shipping. There's not a lot of time for celebrating baked into our model. We get back into our inboxes pretty quickly.

But then it happens. We start to see what sailors accomplish with what we make. They pull off a lee bow maneuver at 40 knots--and it becomes blasé. They foil across an ocean. They ice-in over whole winters up a fjord--and work remotely. They push The Front farther than anyone dared imagine. Then they come back to the dock to tell us what works perfectly and what could work better. In doing so, they remind us why we do this work.

For years, we've relied on what we call the Harken Weather Mark as our commitment to how we will do it:

- **Keep the well-being of our people first**
- **Make the best products at a fair price**
- **Service our customers beyond their expectations**
- **Never lose the basic judgment you've been taught: your sense of right from wrong**

This year, we're articulating a commitment that has become central to how we operate. Our products are designed to perform on the wind in or above the sea. When that arena is under duress, what we love and do is threatened. And we must respond. Harken seeks to lean into this commitment and improve. We will:

- **Work to steadily reduce our impact on the environment**

Good sailing. We'll be watching what you achieve, from Harken offices worldwide.





SMALL BOAT BLOCKS 15 - 42



BIG BOAT BLOCKS 43 - 66



COMPLEMENTARY HARDWARE 67 - 93



TRAVELERS & GENOA LEADS 94 - 129



MAINSAIL HANDLING SYSTEMS 131 - 157



HEADSAIL HANDLING SYSTEMS 159 - 191



WINCHES 192 - 232



HYDRAULICS 233 - 252



REFERENCE 255 - 279



INDEX 280 - 293

Catalog Guide

15 Small Boat Blocks

Fly Blocks
Zircon Blocks
Carbo Air Blocks
T2/T2 Ratchamatic
29 mm
40 mm
57 mm
75 mm
HTE Ratchamatic/Power3 Ratchet
Ratchet
Ratchamatic
Fiddle

Small Boat Flip-Flops/Dinghy Vang
Protexit Exit Blocks
16 mm
Micro
Classic Blocks
Bullet/Dinghy/Exit
2.25"
Hexa-Cat Bases
Two-Speed Mainsheet Systems
Midrange/Midrange Hexaratchet
Wire

43 Big Boat Blocks

Element Blocks
45 mm
60 mm
80 mm
Black Magic Air Blocks
45 mm
57 mm
75 mm
100 mm
125 mm/150 mm
Air Runner Blocks/Crossover
Teardrops/Footblocks
FlatWinder Powered Block
Stainless Cruising ESP
Megayacht Blocks
Mastbase Halyard Leads
Over-The-Top/Flip Flop
V Blocks
High-Load Snatch/1 Ton Twing Block

67 Complementary Hardware

Cam Cleats/Accessories
Cam Bases
Stand-Up Bases
Accessories
Self-Contained Sheaves
Big Boat Sheaves
V Sheaves
High-Load/Narrow/Steering Sheaves
40 & 50 mm Deck Organizers

Big Boat Deck Organizers
Spinnaker Pole Cars
Soft Attachments
Stainless Steel Shackles
Eyestraps
Folding Padeyes/Padeyes
Gizmos
Fixed & Removable Padeyes
Lead Rings
GP Jib Leads/
Bolt-Down Fairleads
Halyard Tensioners/Tiller Extension

94 Travelers & Genoa Leads

Dinghy Pinstop Jib Leads
CB Captive Ball Bearing Travelers &
Genoa Lead Cars
13 mm Micro
22 mm Small Boat
27 mm Midrange
32 mm Big Boat
Windward Sheeting
42 mm Mini-Maxi
64 mm Maxi
CRX Roller
Curved Track
T-Track Genoa Lead Cars
Access Rail System

131 Mainsail Handling Systems

Battcar Systems
T-Track Switch Battcar Systems
Trysail Switch
Furling Mainsail/Outhaul Systems/
Lazy Jacks
Vang-Master

159 Headsail Handling Systems

Carbo Racing Foil
Small Boat Furling Components
Reflex Furling
MKIV Ocean
MKIV
MKIV Underdeck
MKIV Hydraulic
Furling Accessories

192 Winches

SnubbAir
Radial
Aluminum
Chrome
White
Bronze
Powered
Electric & Hydraulic Motors
Unipower
Rewind

Performa
Electric & Hydraulic
Electric Components
Digital System Switch
CLR Mooring Winches
Aluminum
Stainless Steel
Bronze
Carbon Fiber
Air Winches
Pedestals
Pedestal Drive Components
Handles
Service Kits
Air Captive
Electric & Hydraulic Captive Reel
Line Tensioners

233 Hydraulics

Integral Backstay Adjuster
Cylinders
Locking Cylinders
Double-pull Cylinders
Cylinder Blocks & Toggles
Boom Vangs
Grand Prix Cylinders
Valves & Manifolds
MVP-1 & MVP-4 Control Panels
Compact Control Panels
Pumps
Rotary Pumps
Reservoirs/Pump Handles
Accessories
Power Systems

253 Materials & Properties

255 Reference

Warranty/Warnings and Instructions
Trademarks
Maintenance
Genoa Lead Car
Traveler
Mainsheet
Boom Vang
Outhaul
Cunningham
Mastbase & Cabin Top
Spinnaker
Spinnaker Pole Handling
Backstay Adjuster
Mainsail Reefing
Self-Tacking Jibs/Staysail
Metric Conversions/Drilling Guide
Ball Bearing Replacement Chart
Rigging Breaking Loads
Loading Formulas

280 Index

© Harken, Inc. 2024. All rights reserved. No portion of this catalog may be reproduced without the express written permission of Harken, Inc. Printed in U.S.A.

Please refer to p.257 for trademark disclaimers and information.

PERSICO
69F

SMALL BOAT
BLOCKS



NEW FOR 2024

**40mm Zircon Cat
Mainsheet System**
SEE PAGE 17



Carbo Twing Block
SEE PAGE 21



Protexit Blocks
SEE PAGE 32

16 mm
Single/high-load
Cheek/high-load
SEE PAGE 33



Fly Blocks

Harken soft-attach Fly blocks are designed to provide strength without mass, providing sailors with big power in a low-aero package. Designed specifically for high-tech line, these efficient blocks have an incredible working load for their small size. Fly blocks are perfect for use on foiling dinghies and sportboats and for vang cascades and backstay systems on Grand-Prix racers.

18 mm

18 mm blocks feature an integrated stainless steel inner race and rivet, stainless steel ball bearings, and composite fiber-reinforced sideplates.

29 & 40 mm

29 and 40 mm blocks feature a one-piece titanium outer race/sheave, stainless steel ball bearings and inner race, and composite fiber-reinforced sideplates.



Use the 2161 "tight cinching" 18 mm in applications where the block needs to be secured extremely close to the deck.



2161

2698

2158

2180

2171

2173

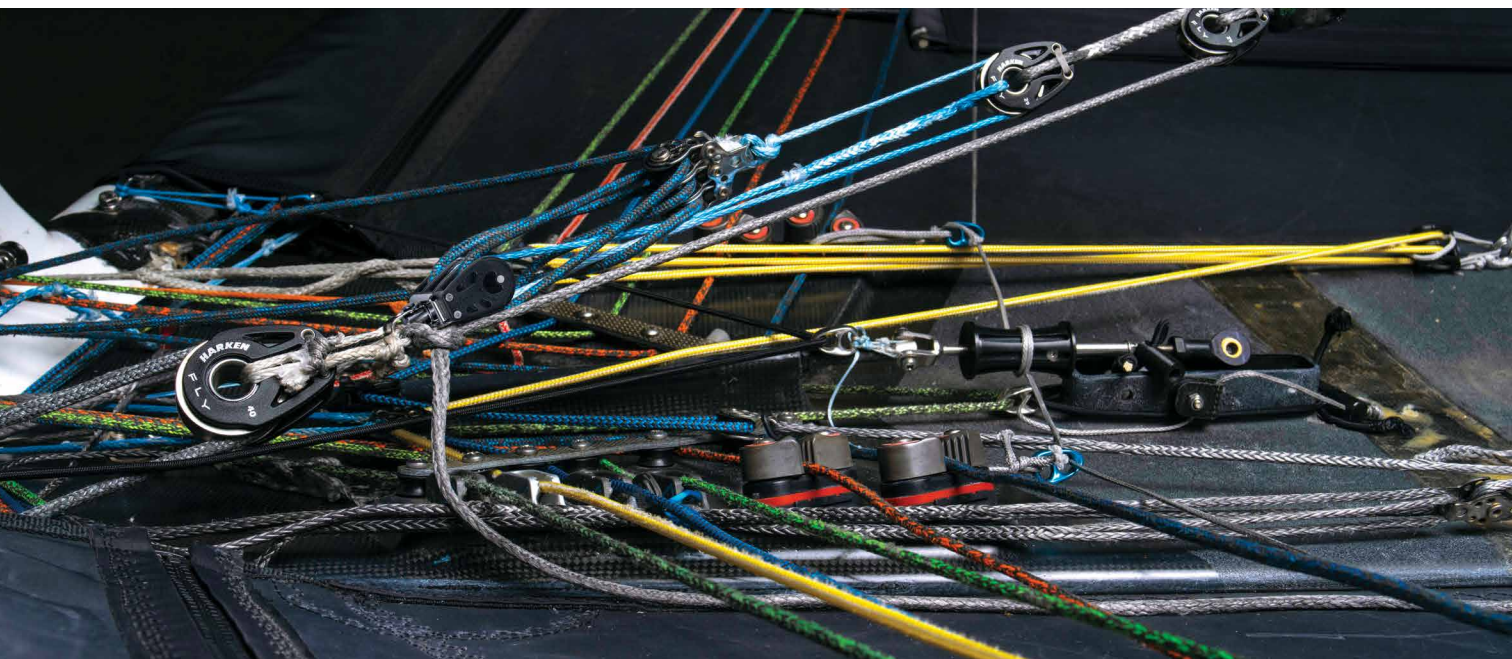

Part No.	Description	Sheave Ø		Length		Weight		Max line Ø		Maximum working load		Breaking load	
		in	mm	in	mm	oz	g	in	mm	lb	kg	lb	kg
2158	18 mm Double	23/32	18	1 3/32	28	.6	17	3/16	5	450	204	1500	680
2161	18 mm Single/narrow	23/32	18	1 3/32	28	.25	7.2	3/16	5	275	125	992	450
2171	29 mm Single*	1 1/8	29	1 3/4	44	.92	26	9/32	7	770	350	1540	700
2173	40 mm Single*	1 9/16	40	2 5/16	58	2.2	62.2	11/32	9	1435	650	2870	1300
2180	18 mm Triple	23/32	18	1 3/32	28	1	28.4	3/16	5	600	272	1100	499
2698	18 mm Single	23/32	18	1 3/32	28	.25	7.2	3/16	5	275	125	992	450

*Lashing line not included.

Zircon Blocks

The core of the new Zircon blocks are industrial ceramic ball bearings mounted inside caged races. The cages keep these bearings apart so they don't bunch up, touch, and stop each other. The result is a VERY free-running block with less energy lost to friction.

Ceramic is a more familiar name for the metal element Zirconium. Zircon bearings are about 7.5X stronger in compression than stainless bearings. They just don't absorb as much energy before starting to roll. You feel it when you need to ease a sail in very light air. These blocks respond! You feel even the slightest fluctuations in sheet load. When used expertly, that means better sail shape and more speed.

We'll be the first to admit Zircon blocks are not for everyone. They're more efficient than other Harken small boat blocks but more expensive too. Here's how we see it: 1. This is competitive. If we don't offer this level of performance, someone else might. 2. Sailors know best. If they try one and find value, they will buy more. The opposite is also true. We're good with that.



2190



2191



2192



2193



2195



2196



2197



2198

Part No.	Description	Sheave Ø		Length		Weight		Max line Ø		Maximum working load		Breaking load	
		in	mm	in	mm	oz	g	in	mm	lb	kg	lb	kg
2190	40 mm Single	1 9/16	40	2 3/8	60	0.81	22.9	5/16	8	250	115	750	340
2191	40 mm Single w/becket	1 9/16	40	2 7/8	73	0.93	26.5	5/16	8	250	115	750	340
2192	40 mm Double	1 9/16	40	2 3/8	60	1.58	44.7	5/16	8	500	230	1500	680
2193	40 mm Double w/becket	1 9/16	40	2 7/8	73	1.68	47.6	5/16	8	500	230	1500	680
2195	57 mm Single	2 1/4	57	3 1/8	79	1.58	44.8	3/8	10	330	150	990	450
2196	57 mm Single w/becket	2 1/4	57	3 3/4	95	1.81	51.4	3/8	10	330	150	990	450
2197	57 mm Double	2 1/4	57	3 1/8	79	3.05	86.4	3/8	10	660	300	1980	900
2198	57 mm Double w/becket	2 1/4	57	3 3/4	95	3.27	92.7	3/8	10	660	300	1980	900

40 mm Zircon Cat Mainsheet System

This new, more compact Zircon ceramic bearing mainsheet system is a testimonial to the power of collaboration. The previous generation of GP mainsheet system had become the standard among catamaran sailors at the highest levels. But these sailors wondered if we could deliver elite performance in a lighter, tighter package. So, we shrunk everything — except what it can do. At the heart are new 40 mm Zircon sheaves it shares with its namesake Zircon blocks. These contribute 30% less 'aero-disruption' and clear the tiller more easily. As before, sailors may swap in any Harken Power 3 ratchet sheave to match weather conditions. They can also choose 10:1, 11:1, or 12:1 purchase and tune the cam cleat angle until it fits their sailing styles perfectly. With a new extended head post and the correct strop length, those sheaves can interlock for max mast rake.



2801

Part No.	Description	Sheave Ø		Weight		Max line Ø		Maximum working load		Breaking load	
		in	mm	oz	g	in	mm	lb	kg	lb	kg
2801	40 mm Zircon Catamaran Mainsheet System – 1.5x grip 57 mm ratchet	1 9/16	40	31.3	888	5/16	8	1200	545	3600	1636



Flying Fifteen © Rafael Benitez

CARBO AIR BLOCKS

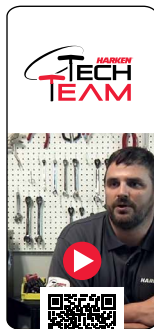

Which Block Do I Need?

These smooth-running powerful performers make trimming easy, no matter how hard the wind blows. Carbo Air blocks are made of tough reinforced composite in a size and style to fit any system: singles, doubles, triples, quads, and quints; ratchets and fiddles; soft and hard attach; 18 - 75 mm. Perfect for main, jib and spinnaker sheets on dinghies and sportboats; control lines on boats of all sizes.

High-strength, lightweight

- Lightweight, strong and reliable fiber-reinforced composite construction.
- Open Air block design eliminates unnecessary material to reduce weight.

Stands up to sun, salt, and time

- Ball bearings, sheave, and sideplates are UV-stabilized.

Low-friction efficiency for fast trim and release

- Free-running ball bearings roll on curved races, efficiently dispersing load for a higher strength block.



Cam-Lock



U-Lock

Shackle blocks lock in two directions or swivel to keep line from twisting

- Cam-Lock or U-Lock allows shackle to be fixed or to swivel.

Materials

For properties see pages 253-254.



Delrin® acetal resin, UV-stabilized:
Ball bearings

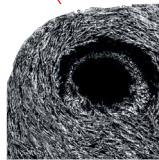

Carbo composite:
Sideplates, sheave

DO NOT use Harken equipment for human suspension unless product is specifically certified and labeled for such use.

Delrin is a registered trademark of E. I. du Pont de Nemours and Company or its affiliates.

Carbo T2 Soft-Attach Blocks

Harken offers these patented, high-strength, soft-attach blocks in 29 to 57 mm sizes. They feature composite sheaves that spin freely on Delrin® ball bearings with curved bearing races. They have no metal shackles or rivets, making them the lightest soft-attach blocks Harken has ever designed.

All T2 blocks are lashed or spliced through the load-bearing center of the block, decreasing the loads on the sideplates and acting as a safety backup for the system.

T2 Blocks

T2 blocks come in single and double configurations and can be tied, spliced, or lashed to almost anything. T2 doubles feature composite line guides that are integrated into the block head. They keep the block aligned correctly by pushing the lashing line to the outer edges of the block's head.

T2 Loop Blocks

The T2 Loop block's on/off loop system slides through the block head and over the anchor post for a secure connection. A SK75 Dyneema® loop is included. Replacement loops available.

T2 Ratchamatic Blocks

The patented T2 Ratchamatic is Harken's newest block to feature the T2 line's styling and soft-attachment system. Pressure on the line engages the ratchet mechanism, which switches seamlessly from free-running to ratchet mode. Unloaded main and jib sheets run out freely during mark roundings, and asymmetrical spinnaker sheets free instantly during jibes.

The weight of this high-strength block is only a few ounces. This is thanks to composite fiber-reinforced sideplates, hardcoat-anodized aluminum sheave, a lightweight soft-attach, and a minimum of moving parts in the ratcheting mechanism.

A length of Spectra® line with a polyester cover is included.



T2 block with open center

Line ties, splices, or lashes to almost anything: cascades, bridles, traveler controls.



T2 Loop block with anchor post

Loops deadend on anchor post for easy installation. No knots or splices needed. Slide the loop through the head and over the anchor post for a secure connection.



T2 Ratchamatic block

Blocks are clearly labeled with high-contrast directional markers for correct reeving and trimming direction.



57 mm T2 Ratchamatic blocks are also available with Power3 sheaves which offer holding power options suitable for a variety of wind conditions. Contact Harken for more information.



Delrin is a registered trademark of E. I. du Pont de Nemours and Company or its affiliates.

Dyneema is a registered trademark of DSM IP Assets B.V. L.L.C.

Spectra is a registered trademark of Honeywell International, Inc.

Part No.	Description	Sheave Ø		Length		Weight		Max line Ø		Maximum working load		Breaking load	
		in	mm	in	mm	oz	g	in	mm	lb	kg	lb	kg
T2													
2146	Single	1 1/8	29	1 11/16	43	.4	12	5/16	8	330	150	1000	454
2147	Double	1 1/8	29	1 11/16	43	.83	23.5	5/16	8	600	272	1900	861
2149	Single	1 9/16	40	2 1/4	57	.9	25	3/8	10	485	220	1200	544
2150	Double	1 9/16	40	2 1/4	57	1.7	48	3/8	10	700	317	2100	952
2152	Single	2 1/4	57	3 1/16	79	2	57	7/16	11	792	359	2380	1080
2153	Double	2 1/4	57	3 1/16	79	3.8	107.5	7/16	11	1080	490	3200	1451
2162	Traveler	1 9/16	40	3 15/32	88	1.4	39	3/16	5	275	125	992	450
T2 Loop													
2148	Single*	1 9/16	40	2 1/4	57	.92	26	3/8	10	485	220	1200	544
2151	Single**	2 1/4	57	3 1/16	79	2	59	7/16	11	792	359	2380	1080
T2 Ratchamatic													
2159	Single	1 9/16	40	2 1/4	57	.9	25	3/8	10	300	136	1000	454
2160 / .RED	Single	2 1/4	57	3 1/16	79	2.5	71	3/8	10	500	227	2000	907

*Includes 2154 loop. **Includes 2155 loop. Replacement loops see page 83.



29 mm Blocks

About Carbo Air blocks: see feature page at beginning of this section.



340



341



342



343



344



345



346



347



348



349



350



371



381



352



Doubles and triples feature U-Locks to hold the swivel in front/side position, or to let it spin freely.



Use as becket block without the additional height of a becket.



353



395



396



High-strength pivoting lead blocks with cams are used for halyard controls on larger keelboats and as "headknockers" on dinghies and beachcats for sheeting directly from the boom. Hole spacing and rivet size are the same as Classic models, making upgrades easy. Cam reverses for either up or down cleating.

Part No.	Description	Sheave Ø		Length		Weight		Shackle pin Ø		Max line Ø		Maximum working load		Breaking load	
		in	mm	in	mm	oz	g	in	mm	in	mm	lb	kg	lb	kg
340	Single/swivel	1 1/8	29	2 5/8	66	.9	26	5/32	4	5/16	8	330	150	1000	454
341	Single/swivel/becket	1 1/8	29	3 1/16	78	1	28	5/32	4	5/16	8	330	150	1000	454
342	Double/swivel	1 1/8	29	2 7/8	73	1.8	51	3/16	5	5/16	8	660	299	1625	737
343	Double/swivel/becket	1 1/8	29	3 3/8	85	1.9	54	3/16	5	5/16	8	660	299	1625	737
344	Triple/swivel	1 1/8	29	2 7/8	73	2.6	74	3/16	5	5/16	8	990	449	2000	907
345	Triple/swivel/becket	1 1/8	29	3 3/8	85	2.7	77	3/16	5	5/16	8	990	449	2000	907
346	Triple/471 Carbo-Cam**	1 1/8	29	2 7/8	73	4.6	130	3/16	5	1/4	6	750	340	1500	680
347	Triple/471 Carbo-Cam/becket**	1 1/8	29	3 3/8	85	4.7	133	3/16	5	1/4	6	900	408	1800	816
348	Single/fixe*	1 1/8	29	1 15/16	49	.8	23			5/16	8	330	150	1000	454
349	Stand-up/fixe*	1 1/8	29	2 3/16	56	1.1	31			5/16	8	330	150	1000	454
350	Cheek	1 1/8	29	2 1/8	53	.6	17			5/16	8	330	150	1000	454
352	90° fixe head*	1 1/8	29	2 1/16	52	.9	26			5/16	8	330	150	1000	454
353	Traveler	1 1/8	29	3 5/8	92	1.2	34			5/16	8	330	150	1000	454
371	Clew block assembly	1 1/8	29	4 7/8	124	1.8	51			5/16	8	330	150	1000	454
381	Double/fixe	1 1/8	29	2 1/8	54	1.2	34			5/16	8	660	299	1625	737
395	Pivoting lead block/468 Cam-Matic**	1 1/8	29	3 15/16	100	3.2	90.7			1/4	6	200	91	650	295
396	Pivoting lead block/471 Carbo-Cam**	1 1/8	29	3 15/16	100	2.96	83.7			1/4	6	150	68	650	295

*Can be used as becket block. **Maximum working loads and breaking loads for blocks based on cam strengths.

40 mm Blocks

About Carbo Air blocks: see feature page at beginning of this section.



2646

Melges 15 © Melges Performance Sailboats / Morgan Kinney



Reversible cam arms.

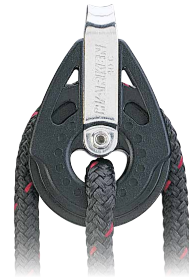

Use as becket block without the additional height of a becket.

A first! The new carbo twing block features a spring-loaded top-opening mechanism so you can pop it on or off the sheet very quickly whenever the breeze dictates. And practice makes doing it one-handed a snap. Carbo side plates and sheave give it the toughness to survive impact as you pull it down tight to the deck.



Part No.	Description	Sheave Ø		Length		Weight		Shackle pin Ø		Max line Ø		Maximum working load		Breaking load	
		in	mm	in	mm	oz	g	in	mm	in	mm	lb	kg	lb	kg
2163	Cheek/becket	1 9/16	40	2 29/32	74	4.9	139			3/8	10	485	220	1620	735
2636	Single/swivel	1 9/16	40	3 3/8	86	1.6	44	5/32	4	3/8	10	485	220	1620	735
2637	Single/swivel/becket	1 9/16	40	4	102	1.7	48	5/32	4	3/8	10	485	220	1620	735
2644	Cheek	1 9/16	40	2 3/4	70	1.2	34			3/8	10	485	220	1620	735
2645	Single/swivel/471 Carbo-Cam**	1 9/16	40	3 3/8	86	4.2	119	5/32	4	1/4	6	150	68	300	136
2646	Single/swivel/471 Carbo-Cam/becket**	1 9/16	40	4	102	4.3	122	5/32	4	1/4	6	300	136	600	272
2649	Traveler	1 9/16	40	4 1/4	108	1.8	52			5/16	8	330	150	1000	454
2650	Single/fixe*	1 9/16	40	2 1/2	64	1.4	40			3/8	10	485	220	1620	735
2652	Stand-up/fixe*	1 9/16	40	2 3/4	70	1.7	48			3/8	10	485	220	1620	735
2659	90° fixe head*	1 9/16	40	2 15/16	75	1.6	44			3/8	10	485	220	1620	735
2699	Twing	1 9/16	40	3 1/2	89	3	86			3/8	10	606	275	1818	825

*Can be used as becket block. **Maximum working loads and breaking loads for blocks based on cam strengths.



40 mm Blocks

About Carbo Air blocks: see feature page at beginning of this section.

Bacardi Invitational Winter Series © Hannah Lee Noll



2156



2157

High-strength pivoting lead blocks with cams are used for halyard controls on larger keelboats and as "headknockers" on dinghies and beachcats for sheeting directly from the boom. Hole spacing and rivet size are the same as Classic models, making upgrades easy. Cam reverses for either up or down cleating.



2638



2639



2640



2641



2642



2643



2647



2648



2654

Part No.	Description	Sheave Ø		Length		Weight		Shackle pin Ø		Max line Ø		Maximum working load		Breaking load	
		in	mm	in	mm	oz	g	in	mm	in	mm	lb	kg	lb	kg
2156	Pivoting lead block/150 Cam-Matic**	1 9/16	40	4 1/2	112	6.6	186			3/8	10	300	136	950	430
2157	Pivoting lead block/365 Carbo-Cam**	1 9/16	40	4 1/2	112	5.5	157			3/8	10	200	91	950	430
2638	Double/swivel	1 9/16	40	3 11/16	94	3.2	86	3/16	5	3/8	10	970	440	2380	1080
2639	Double/swivel/becket	1 9/16	40	4 5/16	110	3.4	90	3/16	5	3/8	10	970	440	2380	1080
2640	Triple/swivel	1 9/16	40	3 11/16	94	4.6	118	3/16	5	3/8	10	1455	660	3050	1383
2641	Triple/swivel/becket	1 9/16	40	4 5/16	110	4.7	122	3/16	5	3/8	10	1455	660	3050	1383
2642	Double/fixed	1 9/16	40	3 1/2	89	2.8	80	3/16	5	3/8	10	970	440	2380	1080
2643	Double/fixed/becket	1 9/16	40	4 3/16	106	2.9	84	3/16	5	3/8	10	970	440	2380	1080
2647	Triple/swivel/471 Carbo-Cam**	1 9/16	40	3 11/16	94	8.2	232	3/16	5	1/4	6	750	340	1500	680
2648	Triple/swivel/471 Carbo-Cam/becket**	1 9/16	40	4 5/16	110	8.3	235	3/16	5	1/4	6	900	408	1800	816
2654	Quad/swivel	1 9/16	40	3 11/16	94	6	170	3/16	5	3/8	10	1455	660	3050	1383

*Can be used as becket block. **Maximum working loads and breaking loads for blocks based on cam strengths.

57 mm Blocks

About Carbo Air blocks: see feature page at beginning of this section.



Part No.	Description	Sheave Ø		Length		Weight		Shackle pin Ø		Max line Ø		Maximum working load		Breaking load	
		in	mm	in	mm	oz	g	in	mm	in	mm	lb	kg	lb	kg
2600	Single/swivel	2 1/4	57	4 5/16	110	3.1	87	3/16	5	3/8	10	792	359	2380	1079
2601	Single/swivel/becket	2 1/4	57	5 3/16	132	3.4	96	3/16	5	3/8	10	792	359	2380	1079
2602	Double/swivel	2 1/4	57	4 3/4	121	6.3	178	1/4	6	3/8	10	1584	720	3300	1500
2603	Double/swivel/becket	2 1/4	57	5 5/8	142	6.6	187	1/4	6	3/8	10	1584	720	3300	1500
2604	Triple/swivel	2 1/4	57	4 3/4	121	9	255	1/4	6	3/8	10	2380	1080	5000	2270
2605	Triple/swivel/becket	2 1/4	57	5 5/8	142	9.3	264	1/4	6	3/8	10	2380	1080	5000	2270
2606	Cheek	2 1/4	57	3 5/8	92	2.4	68			3/8	10	792	359	2380	1079
2615	Single/swivel/150 Cam-Matic*	2 1/4	57	4 5/16	110	9.5	269	3/16	5	3/8	10	300	136	750	340
2616	Single/swivel/150 Cam-Matic/becket*	2 1/4	57	5 3/16	132	15.6	442	3/16	5	3/8	10	600	272	1500	680
2617	Triple/swivel/150 Cam-Matic*	2 1/4	57	4 3/4	121	15.2	431	1/4	6	3/8	10	1500	680	3750	1700
2618	Triple/swivel/150 Cam-Matic/becket*	2 1/4	57	5 5/8	142	15.6	442	1/4	6	3/8	10	1800	816	4500	2040
2631	Quadruple/swivel	2 1/4	57	4 3/4	121	12	340	1/4	6	3/8	10	2380	1080	5000	2270
2762	5-sheave/swivel	2 1/4	57	4 3/4	121	15.8	448	1/4	6	3/8	10	2380	1080	5000	2270

*Maximum working loads and breaking loads for blocks based on cam strengths.



75 mm Blocks

About Carbo Air blocks: see feature page at beginning of this section.

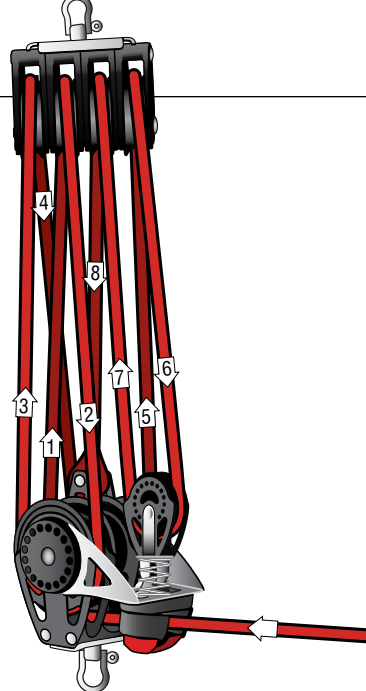

Use with 2687 for a powerful 8:1 purchase.



Part No.	Description	Sheave Ø		Length		Weight		Shackle pin Ø		Max line Ø		Maximum working load		Breaking load	
		in	mm	in	mm	oz	g	in	mm	in	mm	lb	kg	lb	kg
2660	Single/swivel	2 15/16	75	5 3/8	137	6.9	195	1/4	6	9/16	14	1213	550	3638	1650
2661	Single/swivel/becket	2 15/16	75	6 1/2	165	7.5	214	1/4	6	9/16	14	1213	550	3638	1650
2662	Double/swivel	2 15/16	75	6	152	14.2	402	5/16	8	9/16	14	2426	1100	6000	2722
2663	Double/swivel/becket	2 15/16	75	7	178	14.8	419	5/16	8	9/16	14	2426	1100	6000	2722
2664	Triple/swivel	2 15/16	75	6	152	20.5	580	5/16	8	9/16	14	3639	1650	10000	4535
2665	Triple/swivel/becket	2 15/16	75	7	178	21.1	599	5/16	8	9/16	14	3639	1650	10000	4535
2666	Single/swivel/150 Cam-Matic*	2 15/16	75	5 3/8	137	13.4	381	1/4	6	1/2	12	300	136	750	340
2667	Single/swivel/150 Cam-Matic/becket*	2 15/16	75	6 1/2	165	14	397	1/4	6	1/2	12	600	272	1500	680
2668	Triple/swivel/150 Cam-Matic*	2 15/16	75	6	152	27.8	788	5/16	8	1/2	12	1500	680	3750	1700
2669	Triple/swivel/150 Cam-Matic/becket*	2 15/16	75	7	178	28.4	805	5/16	8	1/2	12	1800	816	4500	2040
2677	Quadruple/swivel	2 15/16	75	6 1/4	159	27.2	772	5/16	8	9/16	14	3639	1650	10000	4535

*Maximum working loads and breaking loads for blocks based on cam strengths.

Ratchamatic HTE Blocks

The spring on the HTE (high-threshold engage) version of the 57 mm Carbo Ratchamatic blocks was made stiffer to delay the point where the ratchet engages, allowing the block to run freely more of the time. The ratchet function engages at higher loads to allow the old kite sheet to run freely for crisper gybes.



Ratchet vs Ratchamatic



Pressure on the line engages the ratchet mechanism, which switches seamlessly from free-running to ratchet mode.

Part No.	Description	Sheave Ø		Length		Weight		Shackle pin Ø		Max line Ø		Maximum working load		Breaking load		Holding power*
		in	mm	in	mm	oz	g	in	mm	in	mm	lb	kg	lb	kg	
2625.HTE	Single/swivel/standard grip	2 1/4	57	4 1/16	103	3.7	104	3/16	5	3/8	10	500	227	2000	907	10:1
2165.HTE	Single/swivel/1.5x grip	2 1/4	57	4 1/16	103	3.7	104	3/16	5	3/8	10	500	227	2000	907	15:1
2168.HTE	Single/swivel/2x grip	2 1/4	57	4 1/16	103	3.7	104	3/16	5	3/8	10	500	227	2000	907	20:1

*Measured with 180° wrap.

Power3 Ratchet Blocks

Power3 ratchet blocks provide sailors who race small one-designs with three holding-power options to handle a variety of wind and sea conditions. More choices allow sailors to fine-tune their set-ups in tandem with the purchase that provides the ideal level of power, responsiveness, and grip.

Standard grip: medium/light air
1.5x grip: breeze-on/puffs
2x grip: big breeze/steady



Standard grip:
black

1.5x grip:
titanium

2x grip:
silver



Part No.	Description	Sheave Ø		Length		Weight		Shackle pin Ø		Max line Ø		Maximum working load		Breaking load		Holding power*
		in	mm	in	mm	oz	g	in	mm	in	mm	lb	kg	lb	kg	
Switchable Ratchets																
2135	Single/swivel/standard grip	2 1/4	57	4 1/16	103	3	85	3/16	5	3/8	10	500	227	2000	907	10:1
2166	Single/swivel/1.5x grip	2 1/4	57	4 1/16	103	3	85	3/16	5	3/8	10	500	227	2000	907	15:1
2169	Single/swivel/2x grip	2 1/4	57	4 1/16	103	3	85	3/16	5	3/8	10	500	227	2000	907	20:1
2172	57 mm two-pack/1.5x & 2x grip	2 1/4	57													
2670	Single/swivel/standard grip	2 15/16	75	5 3/8	137	8	227	1/4	6	7/16	12	750	341	3000	1361	15:1
2174	Single/swivel/1.5x grip	2 15/16	75	5 3/8	137	8	227	1/4	6	7/16	12	750	341	3000	1361	22:1
2176	Single/swivel/2x grip	2 15/16	75	5 3/8	137	8	227	1/4	6	7/16	12	750	341	3000	1361	30:1
Ratchamatic																
2625	Single/swivel/standard grip	2 1/4	57	4 1/16	103	3.7	104	3/16	5	3/8	10	500	227	2000	907	10:1
2165	Single/swivel/1.5x grip	2 1/4	57	4 1/16	103	3.7	104	3/16	5	3/8	10	500	227	2000	907	15:1
2168	Single/swivel/2x grip	2 1/4	57	4 1/16	103	3.7	104	3/16	5	3/8	10	500	227	2000	907	20:1
2680	Single/swivel/standard grip	2 15/16	75	5 3/8	137	8.4	238	1/4	6	7/16	12	750	341	3000	1361	15:1
2175	Single/swivel/1.5x grip	2 15/16	75	5 3/8	137	8.4	238	1/4	6	7/16	12	750	341	3000	1361	22:1
2177	Single/swivel/2x grip	2 15/16	75	5 3/8	137	8.4	238	1/4	6	7/16	12	750	341	3000	1361	30:1
T2 Soft-Attach Ratchamatic																
2160	Single/standard grip	2 1/4	57	3 1/16	79	2.5	71			3/8	10	500	227	2000	907	10:1
2167	Single/1.5x grip	2 1/4	57	3 1/16	79	2.5	71			3/8	10	500	227	2000	907	15:1
2170	Single/2x grip	2 1/4	57	3 1/16	79	2.5	71			3/8	10	500	227	2000	907	20:1

*Measured with 180° wrap.



Ratchet Blocks

Carbo ratchet blocks allow sailors to hand-hold loaded lines and offer balance between holding power and controlled easing.

Nylon-resin sideplates are densely packed with long-glass fibers for a compact block with a high strength-to-weight ratio. Machined aluminum sheaves are Hard Lube-anodized for strength and corrosion resistance. Eight facets hold line securely. Ball bearings, sheave, and sideplates are UV-stabilized with carbon black for maximum protection.

40 mm

The 40 mm ratchets are ideal for jib sheets and spinnakers where size and weight are critical. The 2608, 2609, and 2614 have on/off switches; other 40 mm ratchets are always in ratchet mode.

57 mm and 75 mm

The 57 mm and 75 mm switchable ratchets provide precise control with an accessible on/off switch that is easy to operate from both sides of the block.

For the ultimate system, mount a switchable ratchet in the cockpit and a boom-mounted Ratchamatic block directly above for double holding power in heavy air and a free-running mainsheet when it's light. The 75 mm provides up to 15:1 holding power; the 57 mm 10:1.

About Carbo Air blocks: see feature page at beginning of this section.



2135.RED

2608
2135
2670

2609
2136
2671



2178

2614
2137
2672



2138

2139



2610

2611



Ratchet or Ratchamatic?



On/off switch operates from both sides.



All 57 mm and 75 mm ratchet blocks are also available with Power3 sheaves which offer holding power options suitable for a variety of wind conditions.



Switch locks shackle in front or side positions, or lets block swivel to keep line from twisting.

Part No.	Description	Sheave Ø		Length		Weight		Shackle pin Ø		Max line Ø		Maximum working load		Breaking load	
		in	mm	in	mm	oz	g	in	mm	in	mm	lb	kg	lb	kg
40 mm															
2608	Single/swivel	1 9/16	40	3 3/8	86	1.7	49	5/32	4	3/8	10	300	136	1000	454
2609	Single/swivel/becket	1 9/16	40	4	102	1.8	52	5/32	4	3/8	10	300	136	1000	454
2610	Single/swivel/471 Carbo-Cam**	1 9/16	40	3 3/8	86	4.6	129	5/32	4	1/4	6	150	68	300	136
2611	Single/swivel/471 Carbo-Cam/becket**	1 9/16	40	4	102	4.7	132	5/32	4	1/4	6	300	136	600	272
2614	Cheek*	1 9/16	40	2 3/4	70	1.6	44			3/8	10	300	136	1000	454
57 mm															
2135 / .RED	Single/swivel	2 1/4	57	4 1/16	103	3	85	3/16	5	3/8	10	500	227	2000	907
2136	Single/swivel/becket	2 1/4	57	4 15/16	125	3.3	94	3/16	5	3/8	10	500	227	2000	907
2137	Cheek*	2 1/4	57	3 1/4	83	2.5	71			3/8	10	500	227	2000	907
2138	Single/swivel/150 Cam-Matic**	2 1/4	57	4 1/16	103	8.7	247	3/16	5	3/8	10	300	136	750	340
2139	Single/swivel/150 Cam-Matic/becket**	2 1/4	57	4 15/16	125	9	255	3/16	5	3/8	10	600	272	1500	680
2178	Double/swivel	2 1/4	57	4 9/16	116	6.9	195	1/4	6	3/8	10	750	340	1875	851
75 mm															
2670	Single/swivel	2 15/16	75	5 3/8	137	8	227	1/4	6	7/16	12	750	341	3000	1361
2671	Single/swivel/becket	2 15/16	75	6 1/2	165	8.75	248	1/4	6	7/16	12	750	341	3000	1361
2672	Cheek*	2 15/16	75	4 1/16	103	6.3	179			7/16	12	750	341	3000	1361

*Includes RH fasteners and mounting pad. **Maximum working loads and breaking loads for blocks based on cam strengths.

Ratchet Blocks

About Carbo Air blocks: see feature page at beginning of this section.



2612



2613



2619



Cam assembly adjusts and locks in a range of positions for crew accessibility.



2140



2141

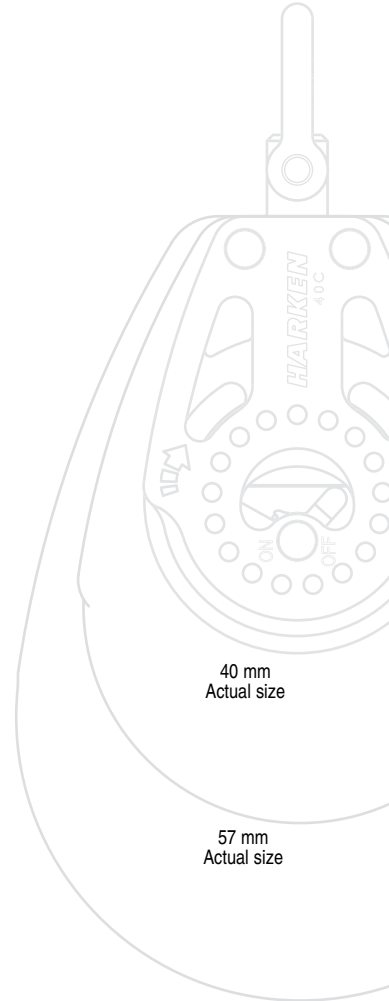

40 mm
Actual size

57 mm
Actual size

75 mm
Actual size

MC Scow © Hannah Lee Noll

Part No.	Description	Sheave Ø		Length		Weight		Shackle pin Ø		Max line Ø		Maximum working load		Breaking load	
		in	mm	in	mm	oz	g	in	mm	in	mm	lb	kg	lb	kg
40 mm															
2612	Triple/swivel/471 Carbo-Cam*	1 9/16	40	3 11/16	94	8.5	242	1/4	6	3/16	5	750	340	1500	680
2613	Triple/swivel/471 Carbo-Cam/becket*	1 9/16	40	4 5/16	110	8.6	245	1/4	6	3/16	5	900	408	1800	816
2619	Triple/471 Carbo-Cam/29 mm block/becket*	1 9/16	40	4 3/4	121	9.5	269	1/4	6	3/16	5	900	408	1800	816
57 mm															
2140	Triple/swivel/150 Cam-Matic*	2 1/4	57	4 1/16	103	15.4	435	1/4	6	3/8	10	1500	680	3750	1700
2141	Triple/swivel/150 Cam-Matic/becket*	2 1/4	57	4 15/16	125	15.7	445	1/4	6	3/8	10	1800	816	4500	2041

*Maximum working loads and breaking loads for blocks based on cam strengths.



Ratchamatic Blocks

The Carbo Ratchamatic is a load-sensing ratchet block that rolls freely in both directions under low loads and automatically engages the ratchet as loads increase. Shifting between ratchet and light-air modes is seamless. Unloaded main and jib sheets run out freely during mark roundings and asymmetrical spinnakers free instantly during jibes.

Ratchet engagement may be adjusted to a higher or lower load according to strength and sailing style. The Ratchamatic cheek block mounts on either port or starboard. The holding power of the 57 mm is as high as 10:1. The 75 mm is up to 15:1.

For the ultimate system, mount a Ratchamatic block on the boom above a cockpit-mounted switchable ratchet to allow the mainsheet to run freely in light air and to double holding power in heavy air.

Use the 2634 with a 402 or 403 swivel arm for a versatile two-speed mainsheet system.

About Carbo Air blocks: see feature page at beginning of this section.



DN World Championship © Harken



2625.
RED

2625
2680



2628
2684

2626.
RED



2626
2681



2627
2683



2633
2682



Ratchet or Ratchamatic?



Adjustable ratchet engagement adapts block to a variety of applications.



Eight-faceted, Hard Lube-anodized aluminum sheave holds line securely.



HTE
HIGH THRESHOLD ENGAGE

All 57 mm and 75 mm Ratchamatic blocks are also available with Power3 sheaves which offer holding power options suitable for a variety of wind conditions. In addition, all 57 mm Ratchamatic blocks can be made with HTE (high threshold engage) sheaves to delay ratchet engagement, allowing them to run freely more of the time.

Part No.	Description	Sheave Ø		Length		Weight		Shackle pin Ø		Max line Ø		Maximum working load		Breaking load		Holding power w/180° wrap 50 lb (23 kg)
		in	mm	in	mm	oz	g	in	mm	in	mm	lb	kg	lb	kg	
57 mm																
2625 / .RED	Single	2 1/4	57	4 1/16	103	3.7	104	3/16	5	3/8	10	500	227	2000	907	10:1
2626 / .RED	Single/becket	2 1/4	57	4 15/16	125	4	113	3/16	5	3/8	10	500	227	2000	907	10:1
2627	Single/150 Cam-Matic**	2 1/4	57	4 1/16	103	9.4	266	3/16	5	3/8	10	300	136	750	340	10:1
2628	Single/150 Cam-Matic/becket**	2 1/4	57	4 15/16	125	9.7	275	3/16	5	3/8	10	600	272	1500	680	10:1
2633	Cheek*	2 1/4	57	3 1/4	83	3.1	89			3/8	10	500	227	2000	907	10:1
75 mm																
2680	Single	2 15/16	75	5 3/8	137	8.4	238	1/4	6	7/16	12	750	341	3000	1361	15:1
2681	Single/becket	2 15/16	75	6 1/2	165	9	255	1/4	6	7/16	12	750	341	3000	1361	15:1
2682	Cheek*	2 15/16	75	4 1/16	103	6.5	184			7/16	12	750	341	3000	1361	15:1
2683	Single/150 Cam-Matic**	2 15/16	75	5 7/16	138	15.5	440	1/4	6	7/16	12	300	136	750	340	15:1
2684	Single/150 Cam-Matic/becket**	2 15/16	75	6 1/2	165	15.5	440	1/4	6	7/16	12	600	272	1500	680	15:1

*Includes RH fasteners and mounting pad. **Maximum working loads and breaking loads for blocks based on cam strengths.

Ratchamatic Blocks

About Carbo Air blocks: see feature page at beginning of this section.



© Nick Woviotis / Skylla Filmworks LLC / Sailing World



Use with 2631/2677 for a powerful 8:1 purchase.

75 mm
Actual
size

57 mm
Actual
size



Part No.	Description	Sheave Ø		Length		Weight		Shackle pin Ø		Max line Ø		Maximum working load		Breaking load		Holding power w/180° wrap 50 lb (23 kg)
		in	mm	in	mm	oz	g	in	mm	in	mm	lb	kg	lb	kg	
57 mm																
2629	Triple/150 Cam-Matic*	2 1/4	57	4 1/16	103	14.9	421	1/4	6	3/8	10	1500	680	3750	1700	10:1
2630	Triple/150 Cam-Matic/becket*	2 1/4	57	4 15/16	125	15.2	431	1/4	6	3/8	10	1800	816	4500	2041	10:1
2632	Triple/150 Cam-Matic/40 mm block/becket*	2 1/4	57	6 1/8	156	18.3	520	1/4	6	3/8	10	1800	816	4500	2041	10:1
2634	Double	2 1/4	57	4 9/16	116	7.2	204	1/4	6	3/8	10	750	340	1875	851	10:1
75 mm																
2685	Triple/150 Cam-Matic*	2 15/16	75	6 3/16	137	31	879	5/16	8	7/16	12	1500	680	3750	1700	15:1
2686	Triple/150 Cam-Matic/becket*	2 15/16	75	6 1/2	165	31.6	896	5/16	8	7/16	12	1800	816	4500	2041	15:1
2687	Triple/150 Cam-Matic/57 mm block/becket*	2 15/16	75	6 1/2	165	34.7	984	5/16	8	7/16	12	1800	816	4500	2041	15:1

*Maximum working loads and breaking loads for blocks based on cam strengths.



Carbo Fiddle Blocks

The Carbo fiddle block line features high-load ball bearings with fitted races for low-friction operation. The 40 mm fiddle is an excellent choice for 3:1 and 4:1 tackles on dinghy vangs and mainsheets, as well as for controls such as cunninghams and internal boom outhauls on larger boats.

The 57 mm fiddle features the Cam-Lock locking system. The switch allows the shackle to lock at 90-degree intervals or to swivel freely.

Ratchet Blocks

The 57 and 75 mm switchable ratchet blocks provide precise on/off control with accessible, easy-to-operate on/off switches on both sides of the block.

About Carbo Air blocks: see feature page at beginning of this section.



All 57 mm and 75 mm ratchet blocks are also available with Power3 sheaves which offer holding power options suitable for a variety of wind conditions.



2657
2623
2692

2658
2624
2693



2655
2621
2690

2656
2622
2691

2673
2694

2674
2695

2675
2696

2676
2697

Part No.	Description	Sheave Ø		Length		Weight		Shackle pin Ø		Max line Ø		Maximum working load		Breaking load	
		in	mm	in	mm	oz	g	in	mm	in	mm	lb	kg	lb	kg
40 mm															
2655	40 mm	1 9/16	40	4 1/2	115	1.8	51	5/32	4	3/8	10	485	220	1620	735
2656	40 mm/becket	1 9/16	40	5 1/8	131	1.9	54	5/32	4	3/8	10	485	220	1620	735
2657	40 mm/471 Carbo-Cam*	1 9/16	40	4 1/2	115	4.4	125	5/32	4	1/4	6	450	204	1500	680
2658	40 mm/471 Carbo-Cam/becket	1 9/16	40	5 1/8	131	4.5	128	5/32	4	1/4	6	485	220	1620	735
57 mm															
2621	57 mm	2 1/4	57	6	153	3.7	105	3/16	5	3/8	10	792	359	2380	1080
2622	57 mm/becket	2 1/4	57	6 7/8	175	4	113	3/16	5	3/8	10	792	359	2380	1080
2623	57 mm/150 Cam-Matic	2 1/4	57	6	153	10.1	286	3/16	5	3/8	10	792	359	2380	1080
2624	57 mm/150 Cam-Matic/becket	2 1/4	57	6 7/8	175	10.4	295	3/16	5	3/8	10	792	359	2380	1080
2673	57 mm/ratchet	2 1/4	57	4 5/8	118	4	113	3/16	5	3/8	10	792	359	2380	1080
2674	57 mm/ratchet/becket	2 1/4	57	5 5/8	143	4.3	121	3/16	5	3/8	10	792	359	2380	1080
2675	57 mm/ratchet/150 Cam-Matic	2 1/4	57	4 5/8	118	10.4	294	3/16	5	3/8	10	792	359	2380	1080
2676	57 mm/ratchet/150 Cam-Matic/becket	2 1/4	57	5 5/8	143	10.7	303	3/16	5	3/8	10	792	359	2380	1080
75 mm															
2690	75 mm	2 15/16	75	6 3/16	157	8.4	238	1/4	6	9/16	14	1212	550	3637	1650
2691	75 mm/becket	2 15/16	75	7 7/16	189	9.1	257	1/4	6	9/16	14	1212	550	3637	1650
2692	75 mm/150 Cam-Matic*	2 15/16	75	6 3/16	157	15	424	1/4	6	1/2	12	900	408	2250	1020
2693	75 mm/150 Cam-Matic/becket	2 15/16	75	7 7/16	189	15.6	443	1/4	6	1/2	12	1212	550	3637	1650
2694	75 mm/ratchet	2 15/16	75	6 3/16	157	9.5	270	1/4	6	1/2	12	1212	550	3637	1650
2695	75 mm/ratchet/becket	2 15/16	75	7 7/16	189	10.2	289	1/4	6	1/2	12	1212	550	3637	1650
2696	75 mm/ratchet/150 Cam-Matic*	2 15/16	75	6 3/16	157	16.1	456	1/4	6	1/2	12	900	408	2250	1020
2697	75 mm/ratchet/150 Cam-Matic/becket	2 15/16	75	7 7/16	189	16.8	475	1/4	6	1/2	12	1212	550	3637	1650

*Maximum working loads and breaking loads for blocks based on cam strengths.

Small Boat 40, 57, & 75 mm Flip-Flop Blocks

Small Boat Flip-Flop blocks pivot around the line axis to keep line close to the deck. Hinged construction allows a variety of lead angles.

Lightweight, machined 6061-T6 aluminum cheeks pivot on fiber-reinforced plastic chocks. Sheave runs exclusively on a ball bearing system for fast trim and release under any load. Ball bearings, sheave, and sideplates are UV-stabilized with carbon black for maximum protection.

Ratchamatic block versions roll freely in both directions under low loads and automatically engage a ratchet mechanism as loads increase, giving sailors a holding power of up to 15:1. The ratchet engagement can be adjusted to a higher or lower load depending on the sailor's strength, sailing style and system usage.

Reversible cam arms adjust and lock in a range of positions for crew accessibility and accommodation of changing lead angles.



Block pivots around the line axis to keep line entry height low.



All 57 mm and 75 mm Ratchamatic blocks are also available with Power3 sheaves which offer holding power options suitable for a variety of wind conditions. In addition, all 57 mm Ratchamatic blocks can be made with HTE (high threshold engage) sheaves to delay ratchet engagement, allowing them to run freely more of the time.



2142
2678
2181



2143
2679
2182
2183



2144
2688



2145
2689

Part No.	Description	Sheave Ø		Width		Length		Height		Weight		Max line Ø		Maximum working load		Breaking load	
		in	mm	in	mm	in	mm	in	mm	oz	g	in	mm	lb	kg	lb	kg
2181	40 mm	1 9/16	40	1 3/4	43	3 3/16	81	2 1/8	54	1.6	45	3/8	10	300	136	750	340
2182	40 mm/150 Cam-Matic*	1 9/16	40	2 9/16	66	3 3/16	81	3 1/2	87	7	200	3/8	10	300	136	750	340
2183	40 mm/468 Micro Cam-Matic*	1 9/16	40	1 7/8	48	3 3/16	81	3 1/4	82	4.1	117	1/4	6	200	91	400	181
2142	57 mm	2 1/4	57	2	50	4 5/16	110	2 1/8	54	5	141	3/8	10	500	227	1584	718
2143	57 mm/150 Cam-Matic*	2 1/4	57	2 5/8	66	4 5/16	110	4 5/16	110	11	304	3/8	10	300	136	600	272
2144	57 mm Ratchamatic	2 1/4	57	2	50	4 5/16	110	2 5/8	66	5.5	156	3/8	10	500	227	1000	554
2145	57 mm Ratchamatic/150 Cam-Matic*	2 1/4	57	2 5/8	66	4 5/16	110	4 3/16	106	12	329	3/8	10	300	136	600	272
2678	75 mm	3	75	2 1/2	64	5 5/8	143	3 3/4	95	9.7	275	9/16	14	750	340	2426	1100
2679	75 mm/150 Cam-Matic*	3	75	2 5/8	66	5 5/8	143	5 9/16	141	17	485	9/16	14	300	136	600	272
2688	75 mm Ratchamatic	3	75	2 1/2	64	5 5/8	143	3 1/2	89	11	304	7/16	12	750	340	1500	680
2689	75 mm Ratchamatic/150 Cam-Matic*	3	75	2 5/8	66	5 5/8	143	5 3/8	137	18	514	7/16	12	300	136	600	272

*Maximum working loads and breaking loads for blocks based on cam strengths.



Protexit Blocks

When you race HARD, and you rip through as many hoists and douses as we do sailing W-L legs all the time, you should expect to start wearing through the sideplates of your halyard exit block right? Wrong! Thanks to Harken Protexit blocks, wear from side angle loading is not inevitable. Protexit's all-aluminum, wear-resistant housing carefully ushers line in and out no matter the angle. There's more: Protexit blocks offer higher working loads than any small boat exit blocks we've ever made. Protexit aluminum sheaves rotate on sleeve bearings with Delrin® sideload balls so they don't deform in extreme conditions, while reducing wear on the halyard, too.

Strong. Durable. Gentle. Protexit blocks protect the race results you work hard to achieve.

Delrin is a registered trademark of E. I. du Pont de Nemours and Company or its affiliates.



Blocks are clearly labeled with part number, line diameter, maximum working load, and directional arrows for line direction.



Bacardi Invitational Winter Series © Hannah Lee Noll

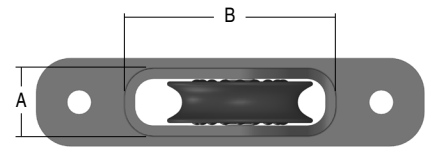

Part No.	Description	Sheave Ø		Length		Weight		Max line Ø		Fasteners (FH)		Fastener spacing	A	B	Maximum working load		Breaking load	
		in	mm	in	mm	oz	g	in	mm	in	mm				mm	mm	mm	mm
1200	30 mm single	1 3/16	30	2 15/16	75	1.3	37	5/16	8	#10	5	57	18.2	45.7	550	250	1103	500
1201	30 mm double	1 3/16	30	3 13/16	97	2	57	5/16	8	#10	5	79	18.2	70.1	550	250	1103	500
1202	40 mm single	1 9/16	40	4 3/16	107	2.6	74	5/16	8	1/4	6	75	19.7	59.2	880	400	1764	800
1203	50 mm single	1 15/16	50	4 5/8	117	4.5	128	1/2	12	1/4	6	90	23.3	71.5	1760	800	3528	1600
1204	60 mm single	2 3/8	60	5 1/16	129	6.3	179	1/2	12	1/4	6	105	24.3	84	2640	1200	5292	2400
1205	40 mm single/wide sheave	1 9/16	40	4 3/16	107	4.5	127	5/16	8	1/4	6	75	30.6	59.2	880	400	1764	800
1206	70 mm single*	2 3/4	70	6 1/4	159	10	257	1/2	12	1/4	6	**	23	91.5	4409	2000	8818	4000
1207	80 mm single**	3 1/8	80	7 1/2	191	14.5	410	9/16	14	5/16	8	**	27	103.2	9921	4500	19842	9000
1208	40 mm double	1 9/16	40	5 5/8	144	4.3	122	5/16	8	1/4	6	120	19.7	105.6	880	400	1764	800
1209	60 mm single/wide sheave	2 3/8	60	5 1/16	129	10.4	296	1/2	12	1/4	6	105	39	84	2640	1200	5292	2400

*3 fasteners — 115mm and 18mm spacing.

** 3 fasteners — 135mm and 25mm spacing.

16 mm

The 16 mm is Harken's smallest block. It is perfect for small synthetic control lines found on high-tech dinghies.

The bearing system uses stainless steel balls in a captive grooved race and has a 113 kg (250 lb) maximum working load—the highest on the market compared to similarly sized blocks.

The 442 uses a spacer and the 404/404HL uses an O-ring to keep the line in the sheave during intermittent loading.

The 467 and 484 use a narrow sheave for extremely small control lines and have a ferrule head for soft attachments. They use the same high load ball system. The 484 features a bronze sheave for added durability.

Use for:

- Dinghy control lines Spinnaker pole trip lines
- Big boat leech lines Outhauls
- Downhauls Cunninghams
- Traveler controls Halyards on prams



Hardened stainless steel inner race for maximum strength-to-weight ratio.



Actual size

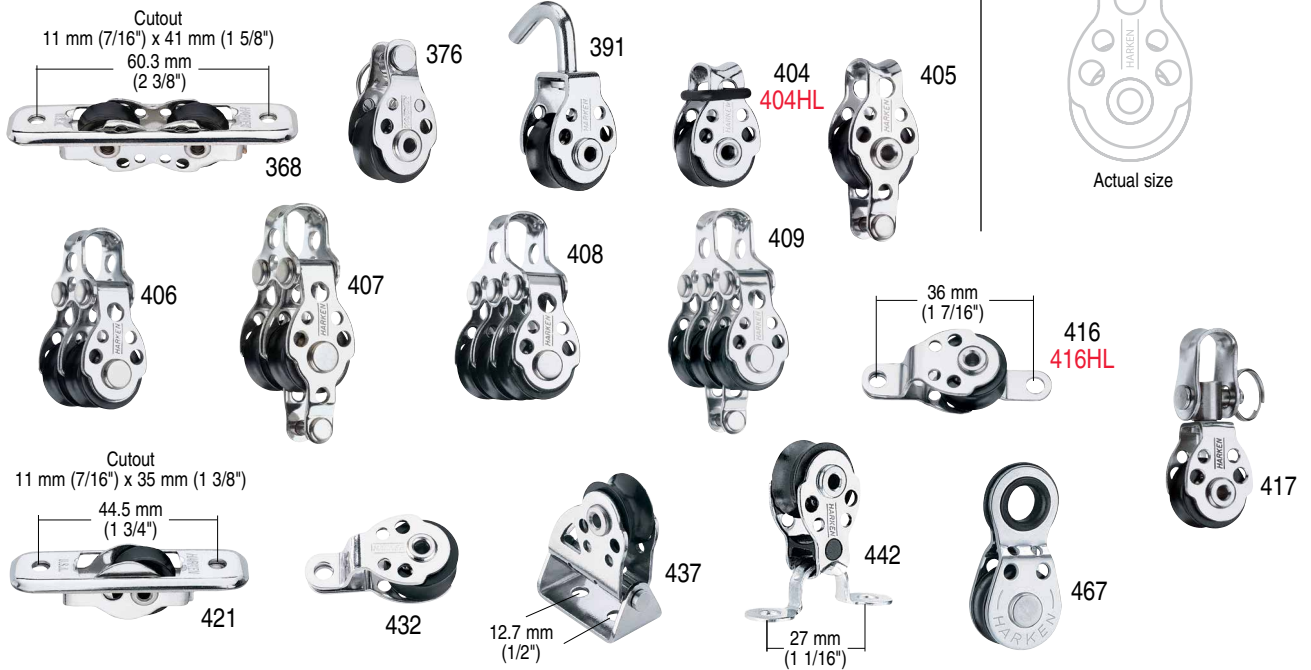

Part No.	Description	Sheave Ø		Length		Weight		Max line Ø		Maximum working load		Breaking load	
		in	mm	in	mm	oz	g	in	mm	lb	kg	lb	kg
368	In-line exit*	5/8	16	3	76	.94	27	7/32	5	250	113	1200	544
376	Forkhead	5/8	16	1 1/8	29	.38	11	7/32	5	250	113	1200	544
391	Hook-in halyard	5/8	16	1 5/8	41	.5	13	7/32	5	250	113	400	181
404	Single**	5/8	16	1 1/8	29	.33	10	7/32	5	250	113	1200	544
404HL	Single/high-load	5/8	16	1 1/8	29	.33	10	7/32	5	500	226	1200	544
405	Single/becket	5/8	16	1 1/2	38	.44	12	7/32	5	250	113	1200	544
406	Double	5/8	16	1 11/16	43	.94	27	7/32	5	450	204	1200	544
407	Double/becket	5/8	16	2 1/8	54	1	28	7/32	5	450	204	1200	544
408	Triple	5/8	16	1 13/16	46	1.44	41	7/32	5	700	318	1200	544
409	Triple/becket	5/8	16	2 1/4	57	1.5	43	7/32	5	700	318	1200	544
416	Cheek*	5/8	16	1 13/16	46	.44	12	7/32	5	250	113	1200	544
416HL	Cheek/high-load	5/8	16	1 13/16	46	.44	12	7/32	5	500	226	1200	544
417	Single/swivel***	5/8	16	1 13/16	46	.63	18	7/32	5	250	113	750	339
421	Through-deck*	5/8	16	2 3/8	60	.63	18	7/32	5	250	113	1200	544
432	Pivot cheek*	5/8	16	1 3/8	35	.38	11	7/32	5	250	113	750	339
437	Flip-flop*	5/8	16	1 5/16	34	.75	21	7/32	5	250	113	1200	544
442	Block/eyestay assembly*	5/8	16	1 3/8	35	.44	12	7/32	5	250	113	1200	544
467	Narrow ferrule head	5/8	16	1 15/32	37	.44	12	5/32	4	250	113	750	339

*4 mm (#8) RH fasteners. **Contact Harken for replacement O-rings HSB340. ***Shackle pin diameter 4 mm (5/32").



Micro Blocks

Low-friction Micro blocks are compact and lightweight. They are ideal for sailboards, smaller dinghies, and lightly loaded control lines on boats of all sizes.

Micro block sheaves run exclusively on ball bearing systems for fast trim and release under any load. Delrin® ball bearings are UV-stabilized with carbon black for maximum protection. Stainless steel sideplates add strength.

Use for:

- Cunninghams/outhauls
- Vangs
- Traveler controls
- Barberhaulers
- Flag halyards
- Leech cords
- Lead car return tackles

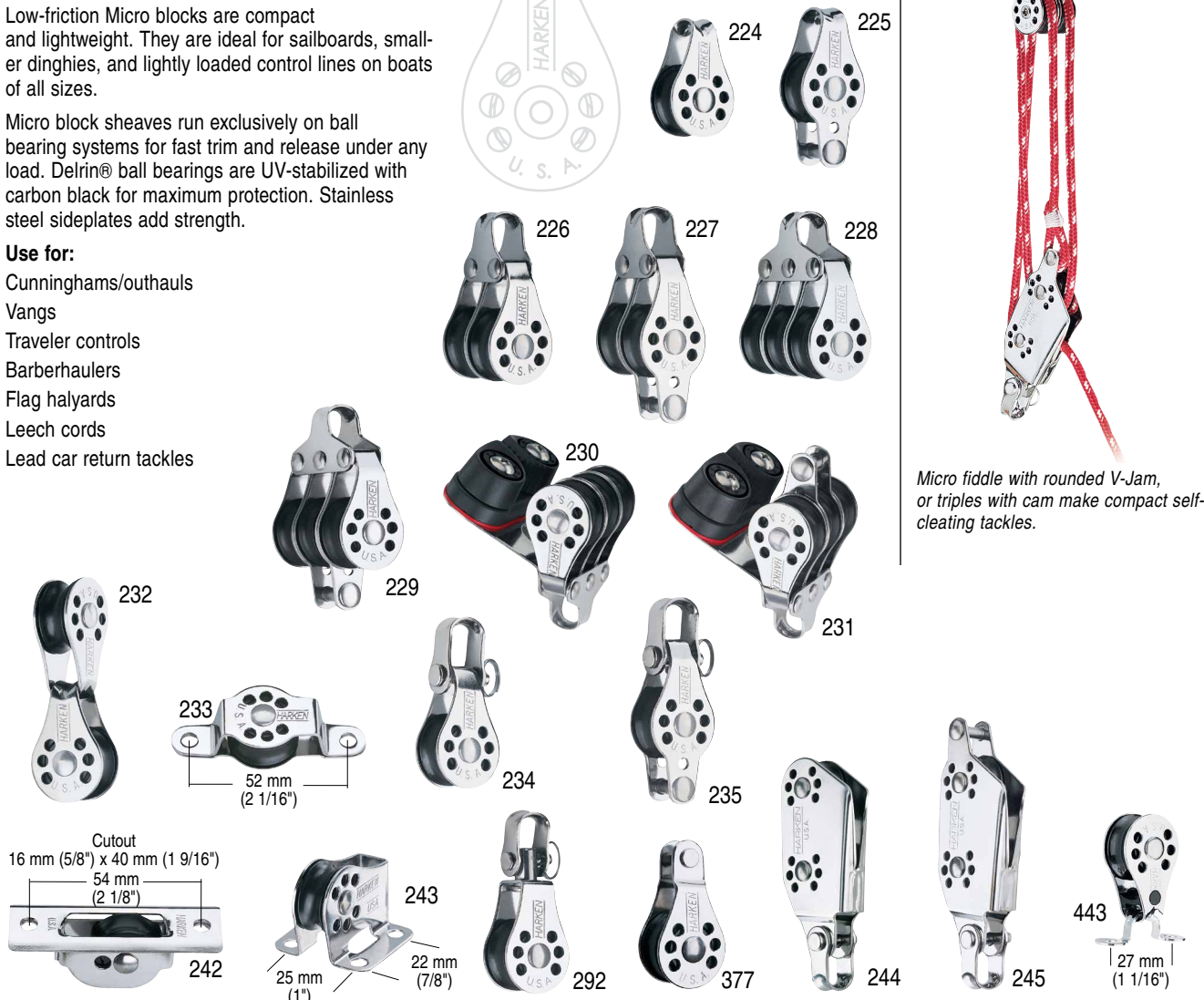

Micro fiddle with rounded V-Jam, or triples with cam make compact self-cleaning tackles.

Delrin is a registered trademark of E. I. du Pont de Nemours and Company or its affiliates.

Sheaves see page 76.

Part No.	Description	Sheave Ø		Length		Weight		Shackle pin Ø		Max line Ø		Maximum working load		Breaking load	
		in	mm	in	mm	oz	g	in	mm	in	mm	lb	kg	lb	kg
224	Single	7/8	22	1 1/2	38	.5	14			1/4	6	200	91	1200	544
225	Single/becket	7/8	22	2	51	.75	21			1/4	6	200	91	1200	544
226	Double	7/8	22	2	51	1.5	43			1/4	6	350	159	1200	544
227	Double/becket	7/8	22	2 1/2	64	1.5	43			1/4	6	350	159	1200	544
228	Triple	7/8	22	2	51	2	57			1/4	6	500	227	1200	544
229	Triple/becket	7/8	22	2 1/2	64	2.25	64			1/4	6	500	227	1200	544
230	Triple/471 Carbo-Cam	7/8	22	2	51	3.5	99			1/4	6	500	227	1200	544
231	Triple/471 Carbo-Cam/becket	7/8	22	2 1/2	64	3.5	99			1/4	6	500	227	1200	544
232	Traveler	7/8	22	2 3/4	71	1.25	35			1/4	6	200	91	1200	544
233	Cheek***	7/8	22	2 1/2	64	.75	21			1/4	6	200	91	1200	544
234	Single/shackle	7/8	22	2 1/4	57	.75	21	3/16	5	1/4	6	200	91	1200	544
235	Single/shackle/becket	7/8	22	2 3/4	71	1	28	3/16	5	1/4	6	200	91	1200	544
242	Through-deck***	7/8	22	2 5/8	67	1	28			1/4	6	200	91	1200	544
243	Upright***	7/8	22	1 1/2	38	1	28			1/4	6	200	91	1200	544
244	Fiddle/V-Jam*	7/8	22	3 1/2	89	2	57	3/16	5	1/4	6	350	159	1200	544
245	Fiddle/V-Jam/becket**	7/8	22	4	102	2	57	3/16	5	1/4	6	350	159	1200	544
292	Single/swivel	7/8	22	2 3/8	60	1	28	5/32	4	1/4	6	200	91	1200	544
377	Forkhead	7/8	22	1 21/32	42	.56	16			1/4	6	200	91	1200	544
443	Block/eyestay assembly‡	7/8	22	1 3/4	45	.56	16			1/4	6	200	91	1000	454

*Use w/225 or 235. **Use w/226. ***#10 (5 mm) RH fasteners. ‡#8 (4 mm) RH fasteners.



CLASSIC BLOCKS

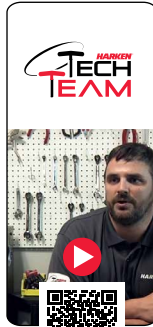

Which Block Do I Need?

The timeless styling of our Classic block line enhances your boat's traditional look. Strong, dependable and exceptionally free-running, these compact blocks are the foundation of the Harken block line. We offer them in multiple configurations for dinghies, scows, beachcats, iceboats, and small offshore racers and cruisers.



Corrosion-resistant, maintain beauty and strength over time

- Ball bearings, sheave, and sideplates are UV-stabilized.
- Corrosion-resistant stainless steel straps reinforce blocks.

Fast trim and release under load

- Free-running ball bearings roll on flat races with minimal friction.

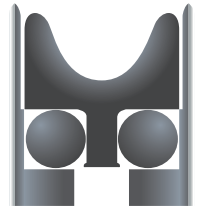

Materials

For properties see pages 253-254.



Delrin® UV-stabilized:
Ball bearings



316 Stainless steel:
Sideplate straps



Shackle blocks lock in two directions or swivel to keep line from twisting

- Set screw allows shackle to be fixed or to swivel.



Bullet Blocks

Low-friction Bullet blocks lead control lines aft. They are compact and lightweight, with fast trim and release under high or low loads. A range of styles lets these blocks adapt to almost all control line applications.

Wire Bullet blocks use roller bearings to carry higher loads and feature Hard Lube-anodized aluminum sheaves for strength and corrosion resistance. Mast exit blocks with cams are used for halyard controls and under boom mainsheets.

About Classic blocks: see feature page at beginning of this section.

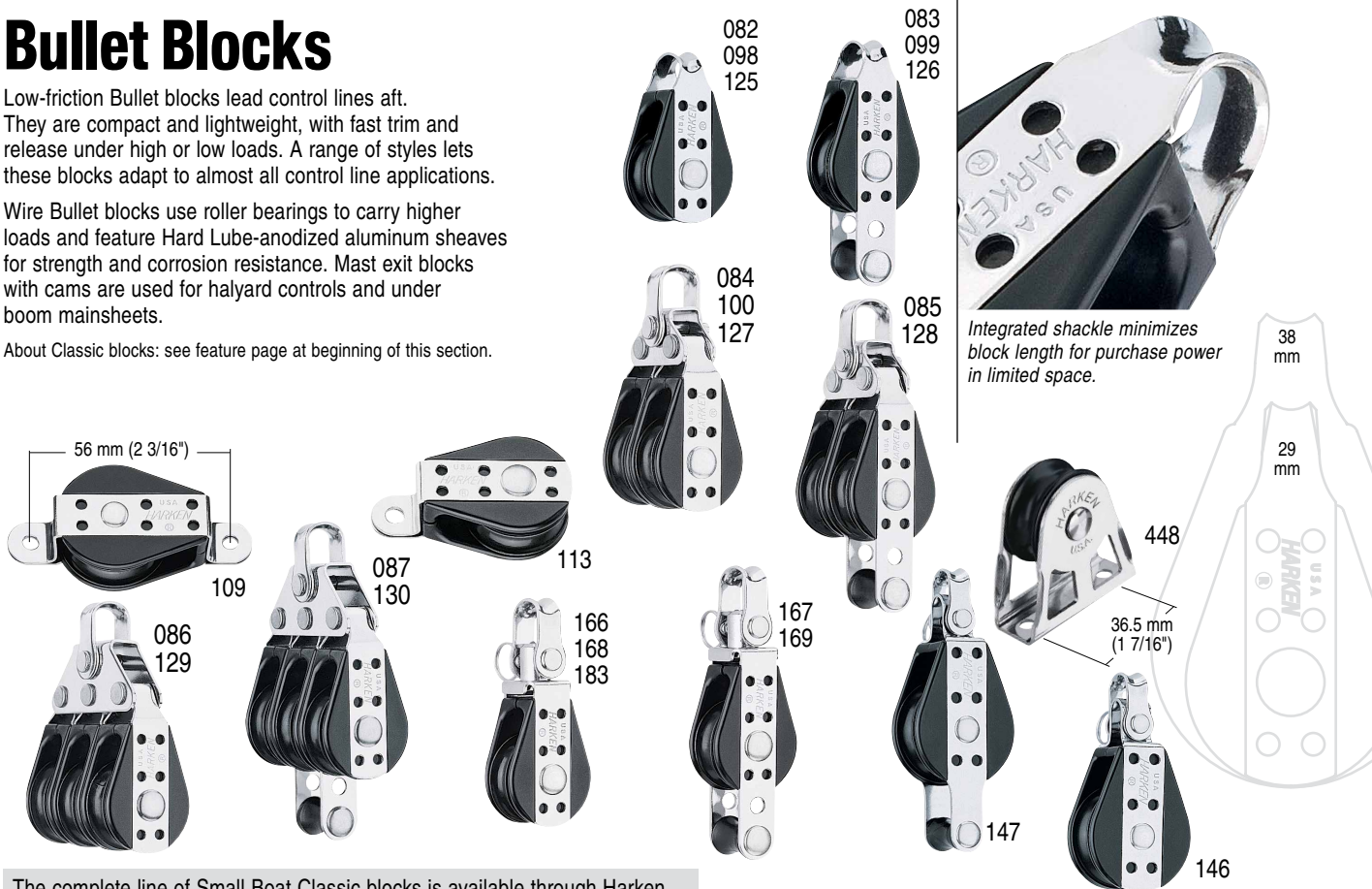

The complete line of Small Boat Classic blocks is available through Harken dealers worldwide and online at www.harken.com/en/shop/small-boat-classic/

Sheaves see page 76.

Part No.	Description	Sheave Ø		Length		Weight		Shackle pin Ø		Max line Ø		Maximum working load		Breaking load	
		in	mm	in	mm	oz	g	in	mm	in	mm	lb	kg	lb	kg
Bullet															
082	Single	1 1/8	29	2	51	1	28			5/16	8	300	136	2000	907
083	Single/becket	1 1/8	29	2 3/4	70	1.25	35			5/16	8	300	136	2000	907
084	Double	1 1/8	29	2 3/4	70	2.5	71	3/16	5	5/16	8	400	181	2000	907
085	Double/becket	1 1/8	29	3 1/2	89	2.75	78	3/16	5	5/16	8	400	181	2000	907
086	Triple	1 1/8	29	3	76	3.75	106	3/16	5	5/16	8	600	272	2000	907
087	Triple/becket	1 1/8	29	3 3/4	95	4.5	128	3/16	5	5/16	8	600	272	2000	907
098	Wire single	1 1/8	29	2	51	1	28			5/16	8	500	227	2000	907
099	Wire single/becket	1 1/8	29	2 3/4	70	1.25	35			5/16	8	500	227	2000	907
100	Double wire	1 1/8	29	2 3/4	70	2.75	78	3/16	5	5/16	8	750	340	2000	907
109	Wire cheek*	1 1/8	29	2 7/8	73	1.25	35			5/16	8	500	227	2000	907
113	Pivoting cheek*	1 1/8	29	1 1/8	29	1	28			5/16	8	300	136	2000	907
166	Single/swivel	1 1/8	29	2 3/4	70	1.5	43	3/16	5	5/16	8	300	136	2000	907
167	Single/swivel/becket	1 1/8	29	3 1/2	89	1.75	50	3/16	5	5/16	8	300	136	2000	907
183	Wire swivel	1 1/8	29	2 3/4	70	1.5	43	3/16	5	5/16	8	500	227	2000	907
Big Bullet															
125	Single	1 1/2	38	2 1/2	64	1.5	43			3/8	10	300	136	2000	907
126	Single/becket	1 1/2	38	3 1/2	89	2	57			3/8	10	300	136	2000	907
127	Double	1 1/2	38	3 1/2	89	4.25	120	1/4	6	3/8	10	600	272	2000	907
128	Double/becket	1 1/2	38	4 1/2	114	4.75	135	1/4	6	3/8	10	600	272	2000	907
129	Triple	1 1/2	38	3 3/4	95	6.5	184	1/4	6	3/8	10	750	340	2000	907
130	Triple/becket	1 1/2	38	4 3/4	121	6.75	191	1/4	6	3/8	10	750	340	2000	907
146	Single/shackle	1 1/2	38	3 1/8	79	2	57	3/16	5	3/8	10	300	136	2000	907
147	Single/shackle/becket	1 1/2	38	4	102	2.25	64	3/16	5	3/8	10	300	136	2000	907
168	Single/swivel	1 1/2	38	3 1/4	83	2.25	64	3/16	5	3/8	10	300	136	2000	907
169	Single/swivel/becket	1 1/2	38	4	102	2.5	71	3/16	5	3/8	10	300	136	2000	907
Upright															
448	Halyard lead block	1 1/2	38	2	51	2.1	60			3/8	10	300	136	600	272

*5mm (#10) RH fasteners.

Bullet, Dinghy & Exit Blocks

About Classic blocks: see feature page at beginning of this section.

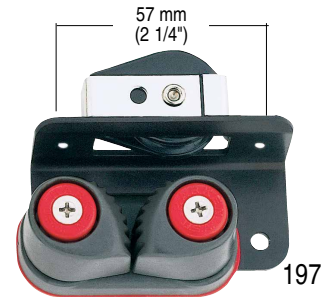
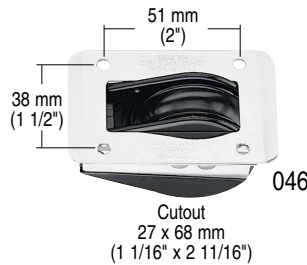
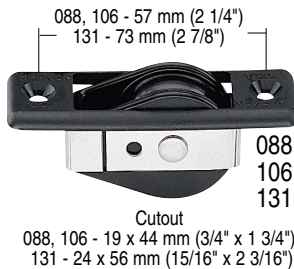
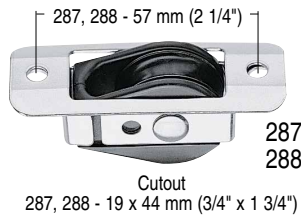
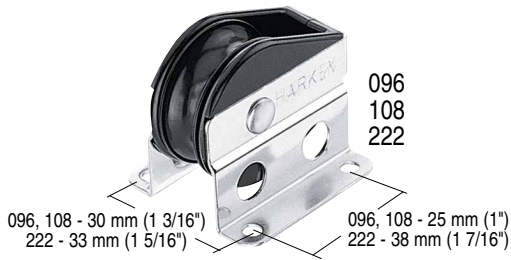

The complete line of Small Boat Classic blocks is available through Harken dealers worldwide and online at www.harken.com/en/shop/small-boat-classic/

Part No.	Description	Sheave Ø		Length		Weight		Max line Ø		Maximum working load		Breaking load	
		in	mm	in	mm	oz	g	in	mm	lb	kg	lb	kg
Bullet													
088	Through-deck*	1 1/8	29	3	76	1.25	35	5/16	8	300	136	2000	907
089	In-line exit*	1 1/8	29	3 3/4	95	1.75	50	5/16	8	400	181	2000	907
096	Upright**	1 1/8	29	1 1/2	38	1.5	43	5/16	8	300	136	2000	907
106	Wire through-deck*	1 1/8	29	3	76	1.25	35	5/16	8	500	227	2000	907
108	Wire upright**	1 1/8	29	1 1/2	38	1.5	43	5/16	8	500	227	2000	907
197	Exit/150 Cam-Matic (port/stbd)**	1 1/8	29	3	76	4.5	128	5/16	8	300	136	2000	907
220	Double upright**	1 1/8	29	1 1/2	38	2.25	64	5/16	8	400	181	2000	907
287	Through-deck**	1 1/8	29	3	76	1.25	35	5/16	8	300	136	2000	907
288	Wire through-deck**	1 1/8	29	3	76	1.5	43	5/16	8	400	181	2000	907
289	In-line exit**	1 1/8	29	3 3/4	95	2.12	60	5/16	8	400	181	2000	907
Big Bullet													
131	Through-deck*	1 1/2	38	3 1/2	89	2.25	64	3/8	10	300	136	2000	907
134	In-line exit*	1 1/2	38	5	127	3.25	92	3/8	10	600	272	2000	907
222	Upright**	1 1/2	38	2 1/4	57	2.5	71	3/8	10	300	136	2000	907
223	Double upright**	1 1/2	38	2 1/4	57	3.25	92	3/8	10	600	272	2000	907
Dinghy													
046	Through-deck‡	1 3/4	44	3	76	4	113	3/8	10	350	159	2000	907

*5 mm (#10) FH fasteners. **5 mm (#10) RH fasteners. ‡4 mm (#8) RH fasteners. Contact Harken for other Dinghy 44 mm (1 3/4") blocks.



2.25" Blocks

About Classic blocks: see feature page at beginning of this section.

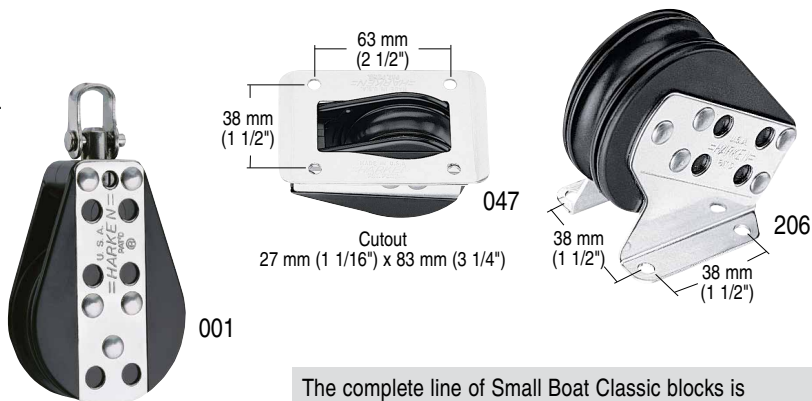

The complete line of Small Boat Classic blocks is available through Harken dealers worldwide and online at www.harken.com/en/shop/small-boat-classic/

Part No.	Description	Sheave Ø		Length		Weight		Shackle pin Ø		Max line Ø		Maximum working load		Breaking load	
		in	mm	in	mm	oz	g	in	mm	in	mm	lb	kg	lb	kg
001	Single	2 1/4	57	4 1/4	108	4.5	128	3/16	5	7/16	12	500	227	2500	1134
047	Through-deck*	2 1/4	57	3 1/2	89	5.5	156			7/16	12	500	227	2500	1134
206	Upright lead**	2 1/4	57	3 1/4	83	5.5	156			7/16	12	500	227	2500	1134

*#8 (4 mm) RH fasteners. **#10 (5 mm) RH fasteners.

Hexa-Cat Bases

Combine the 193 and 170 Hexa-Cat bases with Big Bullet or 2.25" (57 mm) blocks for purchases from 5:1 to 8:1.

About Classic blocks: see feature page at beginning of this section.

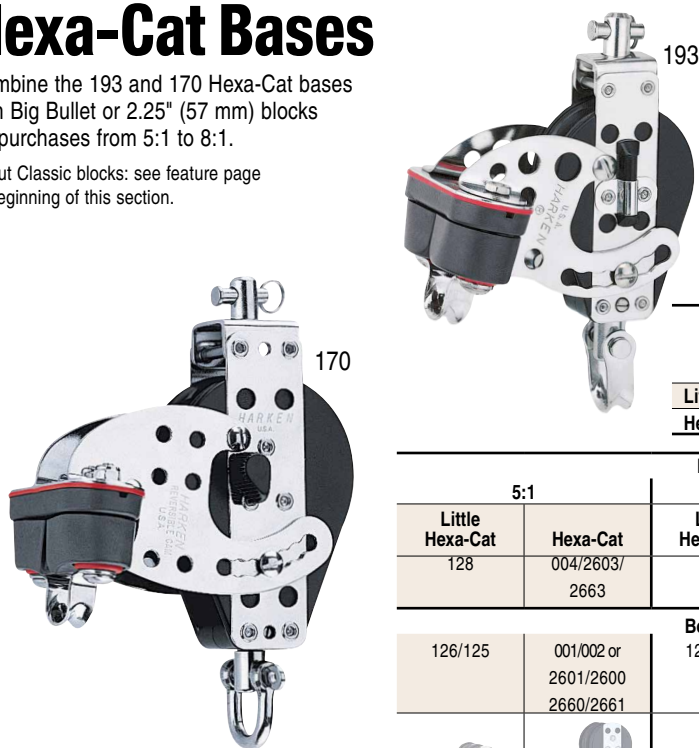

	Hexa-Cat maximum working loads								
	Base	5:1		6:1		7:1		8:1	
	lb	kg	lb	kg	lb	kg	lb	kg	
Little Hexa-Cats	193	1100	499	1100	499	1250	567	1250	567
Hexa-Cats	170	1500	680	1500	680	1500	680	1500	680

Boom blocks (single block on boom)

5:1		6:1		7:1		8:1
Little Hexa-Cat	Hexa-Cat	Little Hexa-Cat	Hexa-Cat	Little Hexa-Cat	Hexa-Cat	Little Hexa-Cat
128	004/2603/ 2663	129	048/2604 or 2664	130	2605 or 2665	2654

Boom blocks (multiple blocks on boom)

126/125	001/002 or 2601/2600 2660/2661	125/127	001/003 or 2602/2600 2662/2660	126/127	002/003 or 2603/2600 2663/2660	2 x 127
---------	--------------------------------------	---------	--------------------------------------	---------	--------------------------------------	---------

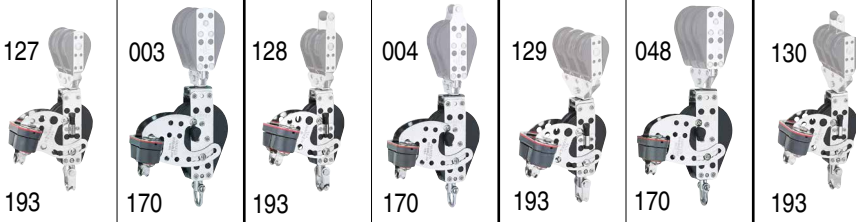

The complete line of Small Boat Classic blocks is available through Harken dealers worldwide and online at www.harken.com/en/shop/small-boat-classic/

Part No.	Description	Sheave Ø		Length		Weight		Shackle pin Ø		Max line Ø		Breaking load	
		in	mm	in	mm	oz	g	in	mm	in	mm	lb	kg
170	Hexa-Cat/150 Cam-Matic	3	76	7 1/4	184	16.5	468	1/4	6	7/16	12	3000	1361
193	Little Hexa-Cat/150 Cam-Matic	2 1/4	57	5 3/4	146	12	340	1/4	6	3/8	10	2500	1134



Dinghy Vang

The dinghy vang features 16 mm sheaves with stainless ball bearings for high loads. The assembly includes a 468 Micro Cam-Matic® cleat that allows precise trimming. It's easy to cleat because it pivots for a fair lead. The unit connects to a mast bracket with a 1/4" pin. The system provides a 12:1 purchase when cascaded with 4:1 blocks. The vang lower unit is available by itself or as part of a kit, which includes a 16 mm double block cascaded to a Micro single with becket for the vang purchase, plus a Micro single for attaching the cunningham.



HSB534

Part No.	Description	Weight		Max sail area		Maximum working load		Breaking load	
		oz	g	ft ²	m ²	lb	kg	lb	kg
431	Dinghy vang kit	10.3	291	125	11.6	400	181	1000	454
HSB534	Dinghy vang lower unit*	8.1	229	125	11.6	400	181	1000	454

*Order your own line, 406, and 225 blocks to complete system.

Two-Speed Mainsheet Systems

Harken gross-trim/fine-tune mainsheet systems are easy to install and use. These optimized systems decrease overall line clutter because they use less line than traditional gross-trim/fine-tune systems. For fast trimming, pull both tails of the mainsheet. To fine-tune or to trim using a higher purchase, pull a single tail.

Two-speed mainsheet systems come in three configurations for boats from 6.5 m to 11.8 m (22 - 39'), with mains as large as 32.4 m² (350 ft²).

Systems

Part No.	Description	Line Ø				Max mainsail area			
		Min		Max		End-boom		Mid-boom	
		in	mm	in	mm	ft ²	m ²	ft ²	m ²
332	3:1/6:1 self-contained system*	5/16	8	3/8	10	240	22.3	180	16.9
383	4:1/8:1 self-contained system*	5/16	8	3/8	10	350	32.4	275	25.5

*Line not included.

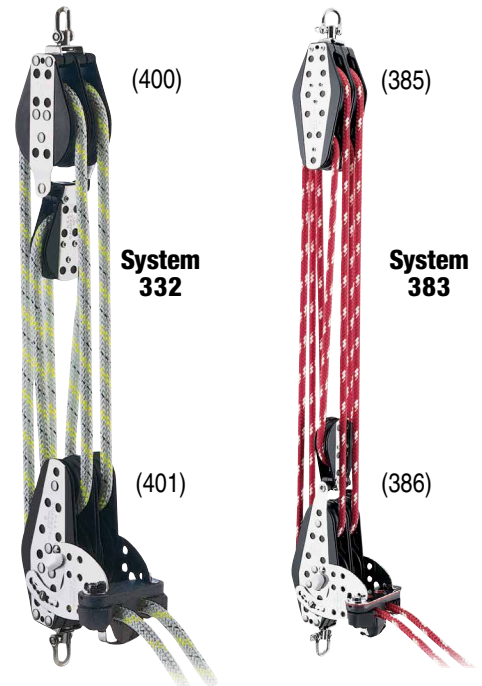

Components

Part No.	Description	Sheave Ø						Length		Weight	
		Primary		Secondary		in	mm	oz	g		
		in	mm	in	mm						
385	Double fiddle	3	76	1 3/4	44	7 3/4	197	21	595		
386	Double fiddle/ratchet/cross block/412 Cam-Matic	3	76	2 1/4, 1 3/4	57, 44	11 1/2	292	37	1049		
400	Double/cross block	3	76	2 1/4	57	9 1/2	241	22	625		
401	Double fiddle/ratchet/412 Cam-Matic	3	76	1 3/4	44	7 1/4	184	31	885		



Ordering Midrange Blocks

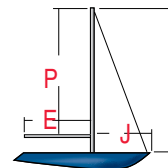

1. Determine block size and type

The tables below are guidelines for typical applications. Additional rigging tips are available at harken.com.

2. Contact

If you have questions, please contact your dealer or Harken Technical Service.

Note: Multihulls and heavy displacement monohulls should reduce the maximum sail areas shown by as much as 25%.

Mainsheet

The farther forward a mainsheet system is on the boom, the higher the loads. Systems with multiple attachment points spread the load over the boom. Use the table to determine if Midrange blocks are strong enough for your mainsail area. See pages 262 - 263 for common configurations.

Mainsheet

		Maximum mainsail area (P x E x .5 x 1.1*)	
		ft ²	m ²
End-boom system	Single attachment	500	46
	Multiple attachment†	540	50
Mid-boom system	Single attachment	425	39
	Multiple attachment†	500	46

*Assumes 10% roach. †Assumes two or more shackles share load on both boom and deck.

Genoa Footblocks

Determine the area of your foretriangle and how many degrees the footblock will deflect the line to select footblock size. For system loading details, see the **Block Loading vs. Angle of Deflection and Genoa System Loading** sections on page 279. See page 259 for common configurations.

Genoa Footblocks

	Maximum 100% foretriangle sail area at 35 knots (I x J x .5)	
	ft ²	m ²
180° turn	150	14
90° turn	215	20

Spinnaker: Symmetrical/Asymmetrical

Use the spinnaker's sail area to determine what size Midrange or high-load Midrange blocks to use for the sheet and aftergyuy controls. See page 269 for common configurations.

Spinnaker

	Maximum spinnaker area (P x E x .5 x 1.8)				
	Standard		High-load		
	ft ²	m ²	ft ²	m ²	
Sheet	Plain	1100	100	1300	120
	Ratchet	900	83	—	—
Aftergyuy*	Mounted amidships	1100	100	1250	115
	Mounted on transom	900	83	1000	93
Maximum "I" dimension					
Masthead halyard	48	14.6	53	16	

*Assumes maximum deflection of 45°.

Mastbase Lead Blocks

Attach blocks to padeyes or 1634 Midrange ESP stand-up bases, or mount mastbase halyard leads to the deck. Use mainsail luff length and foretriangle height to determine what size Midrange or high-load Midrange blocks to use. Carbo blocks or 1986 mastbase halyard leads may be appropriate for applications with lower loads. See page 268 for common configurations.

Mastbase Lead Blocks

	Standard		High-load	
	ft	m	ft	m
Maximum "P" dimension				
Main halyard lead	48	14.6	52	15.8
Maximum "I" dimension				
Genoa halyard lead	46	14	50	15.3
Maximum "I" dimension				
Spinnaker halyard lead	48	14.6	53	16

Running Backstays

The table below shows if Midrange or high-load Midrange blocks are strong enough for the backstay, based on the breaking strength of the runner wire.

Running Backstays

2:1 flying blocks	Maximum breaking load of runner wire			
	Standard		High-load	
	lb	kg	lb	kg
1:1 aftergyuy deck	2200	998	2800	1270
2:1 aftergyuy becket deck	3600	1633	3600	1633
2:1 aftergyuy single deck	4500	2040	5000	2268

Vang

See page 265 for common configurations.

Vang

	Maximum mainsail area (P x E x .5 x 1.1*)	
	ft ²	m ²
Fiddle	400	37
Triple	450	42

*Assumes 10% roach.

Midrange Blocks

About Classic blocks: see feature page at beginning of this section.



STANDARD



HEXARATCHET



Hexaratchet blocks

Midrange Hexaratchet blocks grip loaded sheets, yet allow sailors to ease and trim quickly and with complete control. A switch on the side engages and disengages the ratchet mechanism.

Eight-sided aluminum sheave for 10:1 or 15:1 holding power with 180° wrap.

Torlon is a registered trademark of Solvay Advanced Polymers L.L.C.

Part No.	Description	Sheave Ø		Length		Weight		Shackle pin Ø		Max line Ø		Maximum working load		Breaking load	
		in	mm	in	mm	oz	g	in	mm	in	mm	lb	kg	lb	kg
Standard															
1540	Single	3	76	6 1/8	156	13	367	5/16	8	9/16	14	1800	816	5000	2268
1541	Single/becket	3	76	7 1/8	184	14	397	5/16	8	9/16	14	1800	816	5000	2268
1542	Single/aluminum sheave	3	76	6 1/8	156	15	425	5/16	8	9/16	14	1800	816	5000	2268
1544	Double	3	76	7 1/2	191	25.5	723	5/16	8	9/16	14	2800	1270	7000	3175
1545	Double/becket	3	76	8 1/2	216	26.5	751	5/16	8	9/16	14	2800	1270	7000	3175
1546	Triple	3	76	7 3/4	197	36	1020	5/16	8	9/16	14	3800	1724	8500	3856
1548	Cheek*	3	76	4 3/8	111	11	312			9/16	14	1500	680	4200	1905
1559	Fiddle	3;2	76;51	8 1/2	216	17	482	5/16	8	9/16	14	1800	816	5000	2268
1560	Fiddle/becket	3;2	76;51	9 1/2	241	18	510	5/16	8	9/16	14	1800	816	5000	2268
1564	Fiddle/280 Cam-Matic/becket	3;2	76;51	9 1/2	241	24.5	695	5/16	8	9/16	14	1800	816	5000	2268
1586	Single/high-load**	3	76	6 1/8	156	13	367	5/16	8	9/16	14	2300	1043	5000	2268
Hexaratchet															
1549	Single/clockwise	3	76	6 1/8	156	14	397	5/16	8	9/16	14	1800	816	5000	2268
1550	Single/becket/clockwise	3	76	7 1/8	184	15	425	5/16	8	9/16	14	1800	816	5000	2268
1555	Triple/280 Cam-Matic/clockwise	3	76	7 3/4	197	49	1389	5/16	8	9/16	14	3800	1724	8500	3856
1556	Triple/280 Cam-Matic/becket/clockwise	3	76	8 3/4	222	51	1446	5/16	8	9/16	14	3800	1724	8500	3856
1571	Single/counterclockwise	3	76	6 1/8	156	14	397	5/16	8	9/16	14	1800	816	5000	2268
1565	Fiddle/280 Cam-Matic/clockwise	3;2	76;51	8 1/2	216	26.5	751	5/16	8	9/16	14	1800	816	5000	2268
1566	Fiddle/280 Cam-Matic/becket/clockwise	3;2	76;51	9 1/2	241	27.5	780	5/16	8	9/16	14	1800	816	5000	2268

*6 mm (1/4") RH fasteners. **High-load Midrange blocks use Torlon® ball bearings.



Line/Wire High Strength Blocks

Lightweight, low-friction wire blocks carry wire halyards and high-strength control lines on boats of all sizes.

High-load composite bearings carry axial loads. Hard Lube-anodized sheave for strength and corrosion resistance.

25 mm (1") wire blocks use low-friction thrust washers. 38 mm (1.5") and 51 mm (2") wire blocks feature side-load balls between the sheave and the sideplate to minimize friction from unfair leads.

466 features a forkhead and becket making it useful for vang, halyards and control lines.

Use for:

- Wire halyards
- Vangs
- Control lines



300
304
308



High-load composite bearings handle wire and high-strength line.



466



Sideplates rotate to insert preswaged/Nico-pressed wire fittings.

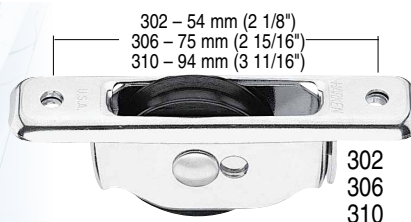

302 - 54 mm (2 1/8")
306 - 75 mm (2 15/16")
310 - 94 mm (3 11/16")

302
306
310

Cutout
302 11 mm (13/32") x 39 mm (1 17/32")
306 13 mm (17/32") x 59 mm (2 5/16")
310 14 mm (9/16") x 73 mm (2 23/32")



301 - 22 mm (7/8")
305 - 32 mm (1 1/4")
309 - 41 mm (1 5/8")

301
305
309



320

312
313
314

© Medora Media / Doug Wake

Part No.	Description	Sheave Ø		Weight		Shackle pin Ø		Max wire Ø		Max line Ø		Maximum working load		Breaking load	
		in	mm	oz	g	in	mm	in	mm	in	mm	lb	kg	lb	kg
300	Single	1	25	1	28	3/16	5	3/32	2	5/32	4	1000	454	2000	907
301	Cheek†	1	25	1.25	35			3/32	2	5/32	4	1000	454	2000	907
302	Through-deck*	1	25	1	28			3/32	2	5/32	4	1000	454	2000	907
304	Single	1 1/2	38	2.75	78	1/4	6	1/8	3	3/16	5	1500	680	3000	1361
305	Cheek†**	1 1/2	38	3.25	92			1/8	3	3/16	5	1500	680	3000	1361
306	Through-deck*	1 1/2	38	3.25	92			1/8	3	3/16	5	1500	680	3000	1361
308	Single	2	51	5.25	149	5/16	8	3/16	5	1/4	6	2000	907	4000	1814
309	Cheek†***	2	51	6	170			3/16	5	1/4	6	2000	907	4000	1814
310	Through-deck**	2	51	5.75	163			3/16	5	1/4	6	2000	907	4000	1814
312	Single/becket	1	25	1.25	35	3/16	5	3/32	2	5/32	4	1000	454	2000	907
313	Single/becket	1 1/2	38	3	85	1/4	6	1/8	3	3/16	5	1500	680	3000	1361
314	Single/becket	2	51	5.75	163	5/16	8	3/16	5	1/4	6	2000	907	4000	1814
320	Ferrule head	1 1/2	38	3	85			1/8	3	3/16	5	1500	680	3000	1361
466	Single forkhead/becket	1	25	1.02	29	3/16	5	3/32	2	5/32	4	1000	454	2000	907

†Fasteners included. *#10 (5 mm) RH fasteners. ** 6 mm (1/4") RH fasteners. *** 8 mm (5/16") RH fasteners.

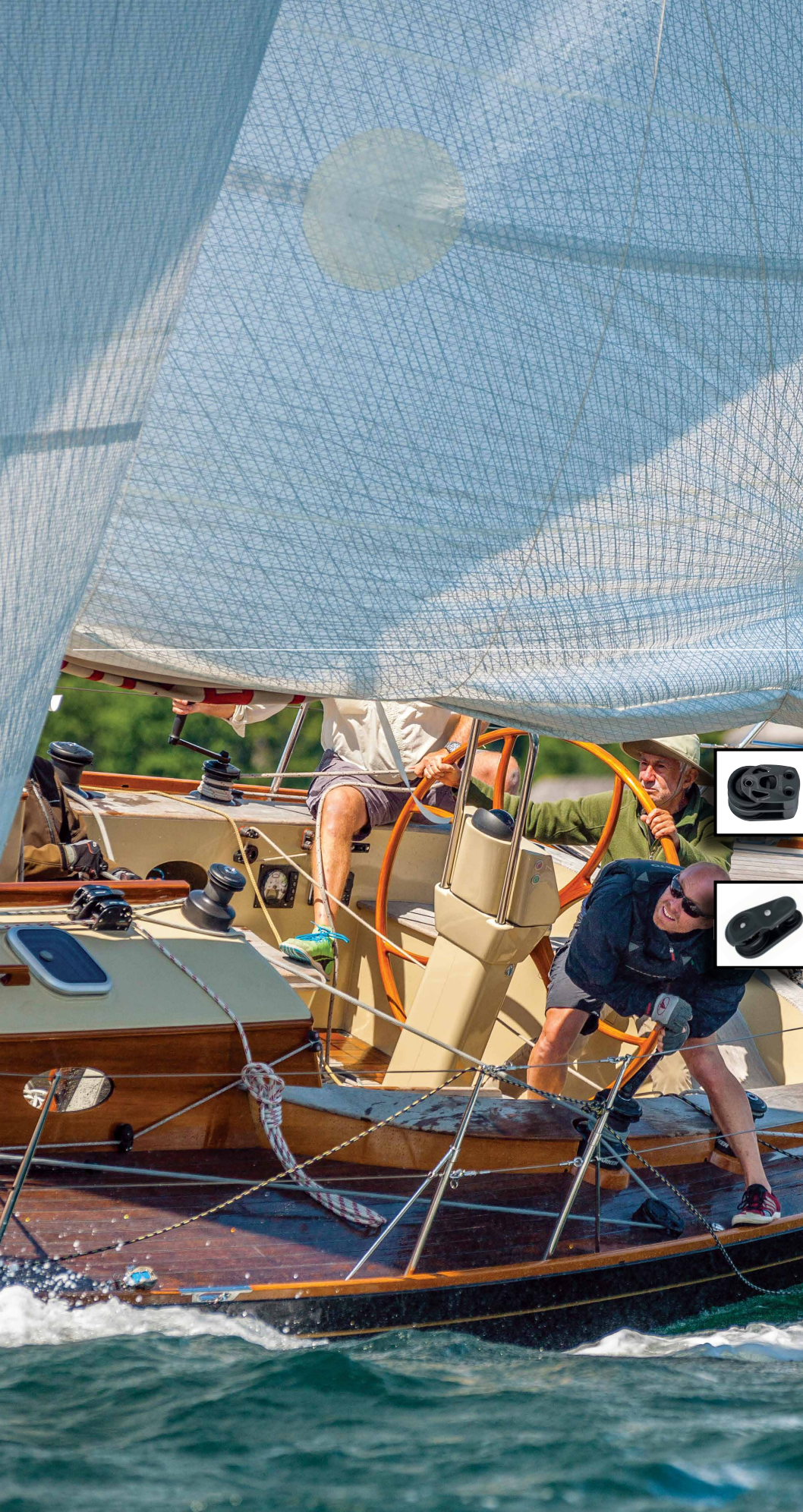

BIG BOAT

BLOCKS



NEW FOR 2024

45 mm Element Blocks
SEE PAGE 47



One Ton Twing Block
SEE PAGE 66



Ordering Big Boat Blocks

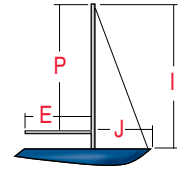

1. Determine block size and type

The tables below are a guideline for typical applications. Additional rigging tips are available at <http://www.harken.com>.

2. Contact

If you have any questions, please contact your dealer or Harken Technical Service.

Note: These hardware specifications assume a boat of moderate displacement sailing in normal conditions. Ultralight displacement boats (ULDB) may use smaller hardware. Heavy displacement boats and multihulls often require stronger hardware.

Mainsheet

Mainsheets are usually attached near the end or the middle of the boom, depending on accessibility and whether the boat is used for racing or cruising. The farther forward a mainsheet system is on the boom, the higher the loads it sees. Systems with multiple attachment points spread the load over the boom. Use the table to choose the appropriate Black Magic, Element, or stainless steel blocks for your mainsail area. See pages 262-263 for common configurations.

	Maximum mainsail area (P x E x .5 x 1.1**)													
	45 mm Element* 57 mm low-load Black Magic		60 mm Element* 57 mm high-load Black Magic		75 mm low-load Black Magic/ 75 mm ESP		80 mm Element* 75 mm high-load Black Magic/ 75 mm stainless		100 mm Black Magic/ 100 mm stainless		125 mm Black Magic		150 mm Black Magic/ 150 mm stainless	
	ft ²	m ²	ft ²	m ²	ft ²	m ²	ft ²	m ²	ft ²	m ²	ft ²	m ²	ft ²	m ²
End-boom														
Single attachment	450	41	550	51	600	56	750	70	900	84	1250	116	1550	144
Multiple attachment**‡	500	46	675	63	720	67	900	84	1100	102	1500	139	1750	163
Mid-boom														
Single attachment	400	37	400	37	450	42	550	51	700	65	1000	93	1375	128
Multiple attachment**	450	41	575	53	600	56	700	65	950	88	1300	121	1525	142

*Element blocks are appropriate for most cruising boats. For high-performance boats, choose Black Magic blocks.

**Assumes 10% roach. ‡Assumes two or more shackles share load on both boom and deck.

Running Backstays

Crews use running backstays to adjust mast bend for different wind conditions. This controls headsail sag as well as the camber (depth) of the mainsail. Use Black Magic Air Runner blocks with higher breaking strengths than your runner wire.

	Maximum breaking load of runner wire									
	57 mm Black Magic Air Runner		75 mm Black Magic Air Runner		100 mm Black Magic Air Runner		125 mm Black Magic Air Runner		150 mm Black Magic Air Runner	
	lb	kg	lb	kg	lb	kg	lb	kg	lb	kg
Flying	2500	1134	10000	4535	15000	6800	22000	10000	30000	13605
2:1 Separate deck	3025	1372	12100	5490	17550	7960	26500	12020	36136	16388
2:1 Becket deck	1875	850	7500	3400	10900	4945	16500	7485	22500	10204
3:1 Deck (block #1)	3713	1684	14850	6735	21600	9800	32700	14835	44550	20203
3:1 Deck (block #2)	4525	2052	18100	8210	26300	11930	39850	18075	54300	24625

Mastbase Lead Blocks

Leading halyards and control lines aft allows crews to raise and lower sails or make tuning adjustments from the cockpit. Attach blocks to the mast collar post or padeyes, or mount mastbase halyard leads to the deck. The table below sizes Black Magic, Element, ESP, stainless steel, and mastbase blocks for different foretriangle heights and luff lengths. See page 268 for common configurations.

	45 mm Element* 57 mm low-load Black Magic/ESP		60 mm Element* 57 mm high-load Black Magic/ fixed MBL** blocks		75 mm low-load Black Magic/ Mast collar post block/ 75 mm ESP		80 mm Element* 75 mm high-load Black Magic/fixed MBL** blocks/ 75 mm stainless		100 mm Black Magic/ 100 mm stainless		125 mm Black Magic	
	ft	m	ft	m	ft	m	ft	m	ft	m	ft	m
Maximum "P" Dimension												
Main halyard	47	14.3	52	15.8	60	18.3	74	22.6	80	25	90	27.5
Maximum "I" Dimension												
Genoa halyard	45	13.7	50	15.2	58	17.7	72	21.9	76	23.2	87	26.5
Spinnaker halyard	47	14.3	53	16.1	60	18.3	74	22.6	82	25	93	28.4

*Element blocks are appropriate for most cruising boats. For high-performance boats, choose Black Magic blocks. **MBL = Mastbase lead blocks.

Ordering Big Boat Blocks



Tattler II, 19.2 m (63'), Gaff-rigged Sandbagger, Van Dam Custom Boats © Alison Langley

Spinnaker: Symmetrical / Asymmetrical

Use the spinnaker's sail area to determine what size Black Magic, Element, or stainless steel blocks to use for the sheet and afterguy controls. See pages 269-270 for common configurations.

	Maximum spinnaker area (I x J x 1.8)													
	45 mm Element* 57 mm low-load Black Magic		60 mm Element* 57 mm high-load Black Magic		80 mm Element* 75 mm low-load Black Magic/ 75 mm ESP		75 mm high-load Black Magic/ 75 mm stainless		100 mm Black Magic/ 100 mm stainless		125 mm Black Magic		150 mm Black Magic/ 150 mm stainless	
	ft ²	m ²	ft ²	m ²	ft ²	m ²	ft ²	m ²	ft ²	m ²	ft ²	m ²	ft ²	m ²
Spinnaker sheet, tack line	720	67	1200	111	1400	130	2000	186	2650	246	4300	400	5600	520
Afterguy**	790	73	1320	123	1500	140	2200	204	2900	269	4700	437	6100	567

*Element blocks are appropriate for most cruising boats. For high-performance boats, choose Black Magic blocks. **Assumes maximum deflection of 45° to winch.

Genoa Footblocks

Footblocks route genoa controls from the lead car to a winch. Double footblocks or snatch blocks enable faster sheet changes. Determine the area of your foretriangle and how many degrees the footblock will deflect the line to select footblock size. For system loading details, refer to the **Block Loading vs Angle of Deflection** and **Genoa System Loading** sections on page 279. See page 259 for common configurations.

Single Genoa Footblocks

	Maximum 100% foretriangle sail area at 40 knots (I x J x .5)													
	45 mm Element* 57 mm Carga moderada Black Magic		60 mm Element* 57 mm Carga moderada Black Magic		80 mm Element* 75 mm Black Magic/ 75 mm inoxidable		100 mm Black Magic/ 100 mm inoxidable		125 mm Black Magic		150 mm Black Magic/ 150 mm inoxidable			
	ft ²	m ²	ft ²	m ²	ft ²	m ²	ft ²	m ²	ft ²	m ²	ft ²	m ²		
180° turn	110	10	180	17	365	34	540	50	800	74	1100	102		
120° turn	125	12	210	20	420	39	630	59	920	85	1256	117		
90° turn	155	14	260	24	515	48	770	72	1130	105	1540	143		

*Element blocks are appropriate for most cruising boats. For high-performance boats, choose Black Magic blocks.

Double Genoa Footblocks

	Maximum 100% foretriangle sail area at 40 knots* (I x J x .5)									
	57 mm low-load Black Magic		60 mm Element** 57 mm high-load Black Magic		80 mm Element** 75 mm Black Magic		100 mm Black Magic		125 mm Black Magic	
	ft ²	m ²	ft ²	m ²	ft ²	m ²	ft ²	m ²	ft ²	m ²
180° turn	75	7	120	11	240	22	360	33	530	49
120° turn	85	8	140	13	275	26	415	39	610	57
90° turn	105	10	175	16	340	32	510	47	750	70

*Based on load on upper sheave. **Element blocks are appropriate for most cruising boats. For high-performance boats, choose Black Magic blocks.



ELEMENT BLOCKS

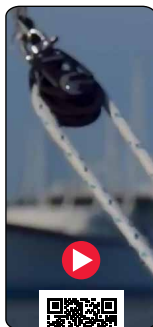

Harken
Element Block

When Harken sets out to create a block for sailors who have always believed they didn't need Harken, what happens? The new Element block. The name hints at its essence: everything that doesn't contribute durability or strength is stripped away. The result is an economical block that does a Harken job.

Element blocks introduce sideplates that combine forged aluminum and compound curves for strength. They are simultaneously contemporary and very robust. Element's design pairs the minimum amount of metal required to protect the sheave with a proven journal bearing. So size for size, Element is priced significantly lower, than our previously least expensive blocks. Compare them to plain bearing blocks from competitors, you'll be surprised. Element: Harken design and engineering—value-price.

Element blocks accept line from 8 - 16 mm. They are offered in singles, doubles, triples, fiddles, and footblocks in 45, 60 and 80 mm sizes.

Stands up to sun, salt, and impact

- Aluminum sideplates are forged for strength and sheave protection.
- Sideplates are hardcoat-anodized to resist corrosion.
- Bearing sheave of tough composite resists corrosion for a long service life.
- Shackles are strong, corrosion-resistant stainless steel.

Materials

For properties see pages 253-254.



6061-T6 aluminum:
Hardcoat-anodized sideplates



Shackle blocks lock in two directions or swivel to keep line from twisting

- Removable headpost lock allows shackle to be fixed or to swivel.

45 mm Blocks

About Element blocks: see feature page at beginning of this section.

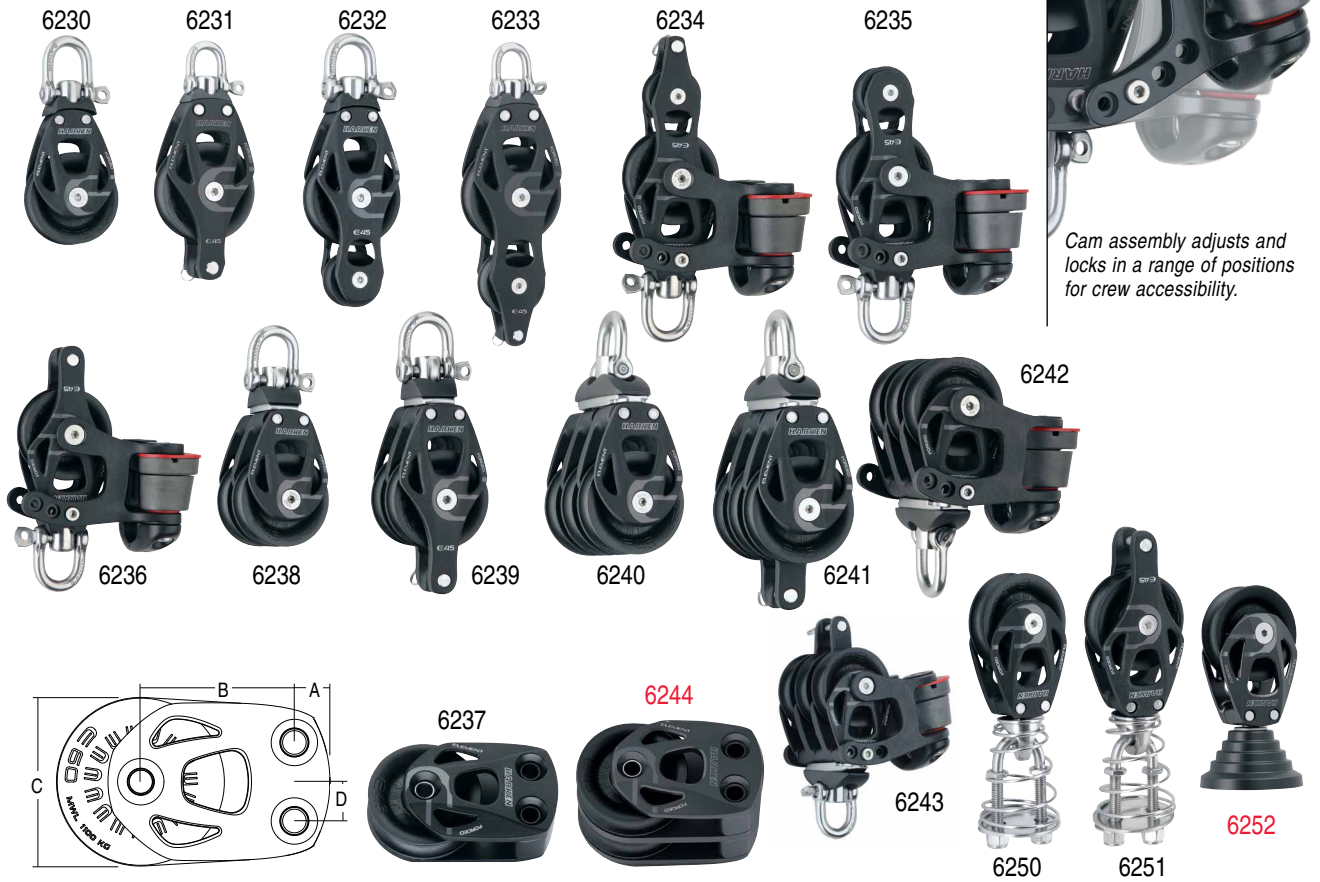

Part No.	Description	Sheave Ø		Length		Weight		Shackle pin Ø		Max line Ø		Maximum working load		Breaking load	
		in	mm	in	mm	oz	g	in	mm	in	mm	lb	kg	lb	kg
6230	Single/swivel	1 3/4	45	4	102	3.6	103	1/4	6	1/2	12	1543	700	3086	1400
6231	Single/swivel/becket	1 3/4	45	4 3/4	121	4.0	115	1/4	6	1/2	12	1543	700	3086	1400
6232	Fiddle/swivel	1 3/4	45	5 1/8	130	4.4	126	1/4	6	5/16	8	1543	700	3086	1400
6233	Fiddle/swivel/becket	1 3/4	45	5 3/4	146	4.6	130	1/4	6	5/16	8	1543	700	3086	1400
6234	Fiddle/150 Cam-Matic/swivel/becket	1 3/4	45	5 3/4	146	8.6	245	1/4	6	5/16	8	1213	550	2426	1100
6235	Fiddle/150 Cam-Matic/swivel	1 3/4	45	5 1/8	130	8.4	241	1/4	6	5/16	8	900	408	1800	816
6236	Single/150 Cam-Matic/swivel/becket	1 3/4	45	4 3/4	121	8.1	230	1/4	6	1/2	12	600	272	1200	544
6238	Double/swivel	1 3/4	45	4 1/4	108	6.3	180	1/4	6	1/2	12	1929	875	3858	1750
6239	Double/swivel/becket	1 3/4	45	5	127	6.8	195	1/4	6	1/2	12	1929	875	3858	1750
6240	Triple/swivel	1 3/4	45	4 1/4	108	9.3	265	1/4	6	1/2	12	2315	1050	4630	2100
6241	Triple/swivel/becket	1 3/4	45	5	127	9.6	275	1/4	6	1/2	12	2315	1050	4630	2100
6242	Triple/150 Cam-Matic/swivel	1 3/4	45	4 1/4	108	14.7	420	1/4	6	1/2	12	1499	680	2998	1360
6243	Triple/150 Cam-Matic/swivel/becket	1 3/4	45	5	127	15.1	430	1/4	6	1/2	12	1799	816	3598	1632
6250	Stand-up	1 3/4	45	4 7/8	123	5.3	150			1/2	12	1543	700	3086	1400
6251	Stand-up/becket	1 3/4	45	5 5/8	143	5.8	164			1/2	12	1543	700	3086	1400
6252	Single Standup w/ Boot*	1 3/4	45	3 11/16	94	4.3	122			1/2	12	1543	700	3086	1400

*Includes padeye. 5 mm (#10) fasteners, fastener circle: 30 mm (1 3/16).

Footblock Dimensions

Part No.	A		B		C		D	
	in	mm	in	mm	in	mm	in	mm
6237/6244	7/16	11	1 5/8	41.5	1 3/4	45	3/8	9.5

Footblock

Part No.	Description	Sheave Ø		Length		Height		Weight		Max line Ø		Maximum working load		Breaking load		Fasteners (FH)
		in	mm	in	mm	in	mm	oz	g	in	mm	lb	kg	lb	kg	
6237	Single footblock	1 3/4	45	3	76	1	25	3.5	100	1/2	12	1543	700	3086	1400	6
6244	Double footblock	1 3/4	45	3	76	1 3/4	45	5.6	160	1/2	12	1018	466	2036	933	6

60 mm Blocks

About Element blocks: see feature page at beginning of this section.

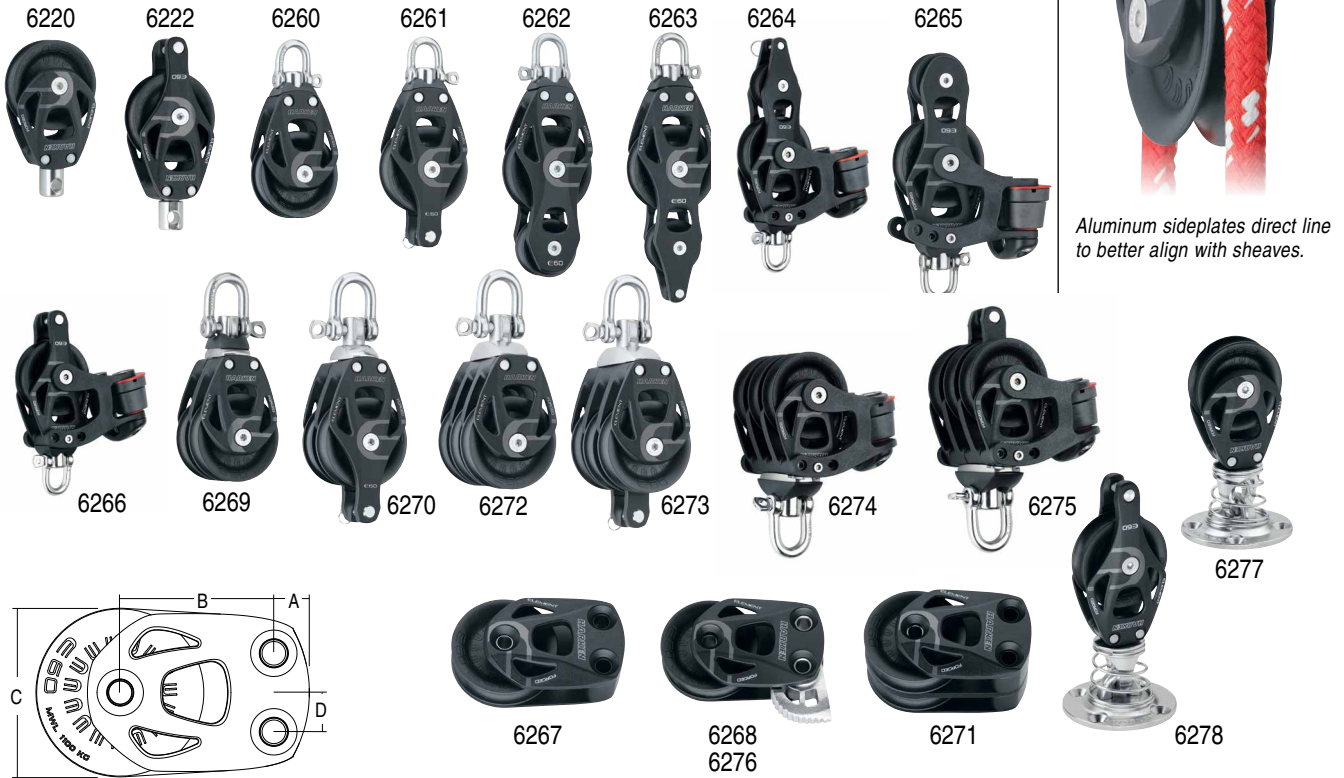

Part No.	Description	Sheave Ø		Length		Weight		Shackle pin Ø		Max line Ø		Maximum working load		Breaking load	
		in	mm	in	mm	oz	g	in	mm	in	mm	lb	kg	lb	kg
6220	Mastbase/single/swivel	2 3/8	60	4 1/8	105	5.5	155								
6222	Mastbase/single/swivel/becket	2 3/8	60	5 1/32	128	6.1	175	5/16	8	9/16	14	2425	1100	4850	2200
6260	Single/swivel	2 3/8	60	4 3/4	121	6.1	175	1/4	6	9/16	14	2425	1100	4850	2200
6261	Single/swivel/becket	2 3/8	60	5 3/4	146	7	200	1/4	6	9/16	14	2425	1100	4850	2200
6262	Fiddle/swivel	2 3/8	60	6 1/2	165	8.4	240	1/4	6	3/8	10	2425	1100	4850	2200
6263	Fiddle/swivel/becket	2 3/8	60	7 1/8	181	8.75	250	1/4	6	3/8	10	2425	1100	4850	2200
6264	Fiddle/150 Cam-Matic/swivel/becket	2 3/8	60	7 1/8	181	13.0	370	1/4	6	3/8	10	1213	550	2426	1100
6265	Fiddle/150 Cam-Matic/swivel	2 3/8	60	6 1/2	165	12.6	360	1/4	6	3/8	10	900	408	1800	816
6266	Single/150 Cam-Matic/swivel/becket	2 3/8	60	5 3/4	146	11.2	320	1/4	6	1/2	12	600	272	1200	544
6269	Double/swivel	2 3/8	60	5 3/4	146	12.4	355	5/16	8	9/16	14	3032	1375	6064	2750
6270	Double/swivel/becket	2 3/8	60	6 3/4	171	14.7	420	5/16	8	9/16	14	3032	1375	6064	2750
6272	Triple/swivel	2 3/8	60	5 3/4	146	18.2	520	5/16	8	9/16	14	3638	1650	7276	3300
6273	Triple/swivel/becket	2 3/8	60	6 1/2	165	18.9	540	5/16	8	9/16	14	3638	1650	7276	3300
6274	Triple/150 Cam-Matic/swivel	2 3/8	60	5 3/4	146	24.2	690	5/16	8	1/2	12	1499	680	2998	1360
6275	Triple/150 Cam-Matic/swivel/becket	2 3/8	60	6 1/2	165	24.9	710	5/16	8	1/2	12	1799	816	3598	1632
6277	Stand-up	2 3/8	60	5 1/4	133	13.8	391			9/16	14	2425	1100	4850	2200
6278	Stand-up/becket	2 3/8	60	6 1/8	155	14.8	419			9/16	14	2425	1100	4850	2200

Footblock Dimensions

Part No.	A		B		C		D	
	in	mm	in	mm	in	mm	in	mm
6267/6268/6271/6276	1/2	12.5	2 5/32	54.5	2 3/8	60	9/16	14

Footblocks

Part No.	Description	Sheave Ø		Length		Height		Weight		Max line Ø		Maximum working load		Breaking load		Fasteners (FH)
		in	mm	in	mm	in	mm	oz	g	in	mm	lb	kg	lb	kg	
6267	Single footblock	2 3/8	60	4	102	1 3/16	30	5.6	160	9/16	14	2425	1100	4850	2200	8
6268	Single footblock/lockoff	2 3/8	60	4	102	1 3/16	30	7.4	210	9/16	14	2425	1100	4850	2200	8
6271	Double footblock	2 3/8	60	4	102	2 3/16	55	9.3	265	9/16	14	1600	725	3200	1450	8
6276	Single footblock/lockoff/left	2 3/8	60	4	102	1 3/16	30	7.4	210	9/16	14	2425	1100	4850	2200	8

80 mm Blocks

About Element blocks: see feature page at beginning of this section.

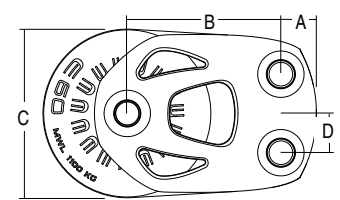
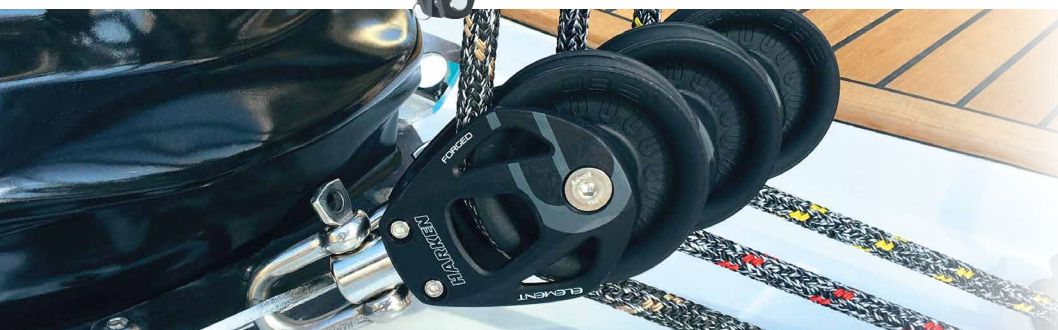
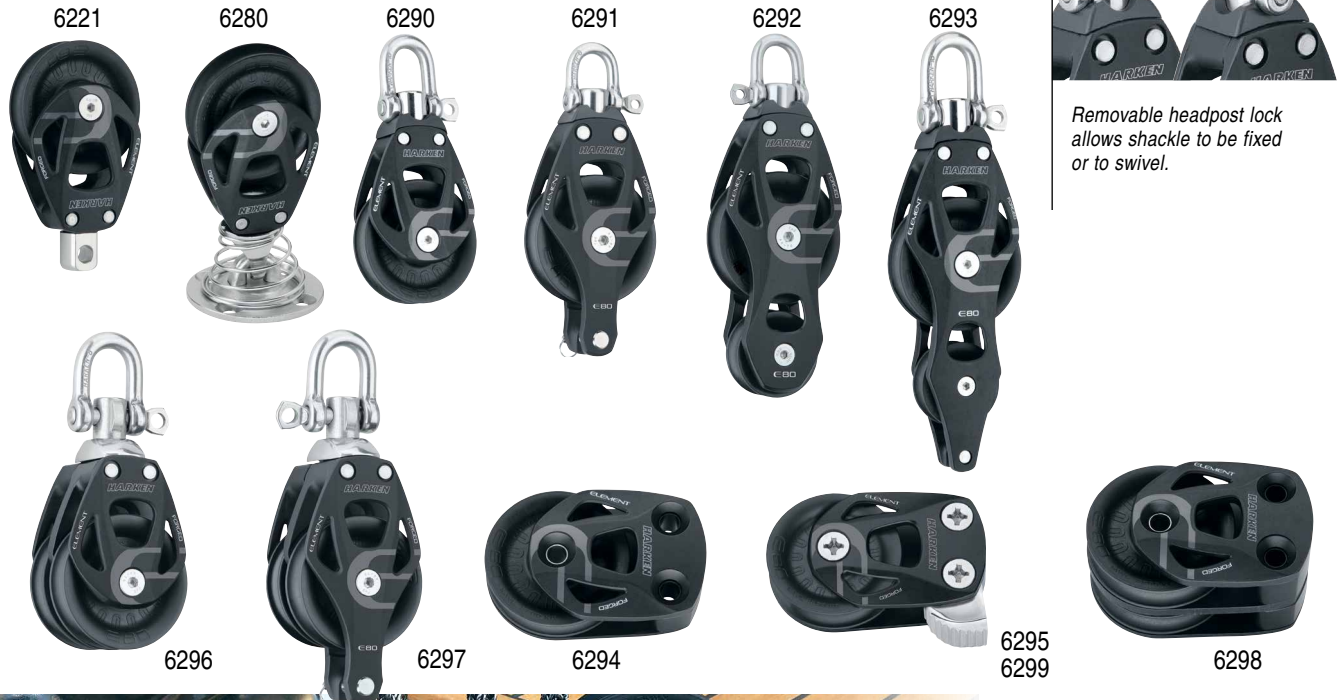

Part No.	Description	Sheave Ø		Length		Weight		Shackle pin Ø		Max line Ø		Maximum working load		Breaking load	
		in	mm	in	mm	oz	g	in	mm	in	mm	lb	kg	lb	kg
6221	Mastbase/single/swivel	3 1/8	80	5 1/2	138	12.6	358	10	5/8	16	4850	2200	9700	4400	
6280	Stand-up	3 1/8	80	6 9/16	166	23.6	670		5/8	16	4850	2200	9700	4400	
6290	Single/swivel	3 1/8	80	6 3/4	171	16.6	475	3/8	10	5/8	16	4850	2200	9700	4400
6291	Single/swivel/becket	3 1/8	80	8	203	18.9	540	3/8	10	5/8	16	4850	2200	9700	4400
6292	Fiddle/swivel	3 1/8	80	9	229	21.4	610	3/8	10	9/16	14	4850	2200	9700	4400
6293	Fiddle/swivel/becket	3 1/8	80	10	254	22.4	640	3/8	10	9/16	14	4850	2200	9700	4400
6296	Double/swivel	3 1/8	80	7 1/2	191	32.0	915	1/2	12	5/8	16	6064	2750	12128	5500
6297	Double/swivel/becket	3 1/8	80	8 3/4	222	34.3	980	1/2	12	5/8	16	6064	2750	12128	5500

Footblock Dimensions

Part No.	A		B		C		D	
	in	mm	in	mm	in	mm	in	mm
6294/6295/6298/6299	3/4	19.5	2 13/32	61	3 1/8	80	25/32	19.8

Footblocks

Part No.	Description	Sheave Ø		Length		Height		Weight		Max line Ø		Maximum working load		Breaking load		Fasteners (FH)
		in	mm	in	mm	in	mm	oz	g	in	mm	lb	kg	lb	kg	
6294	Single footblock	3 1/8	80	4 1/2	114	1 7/16	36	10.9	310	5/8	16	4850	2200	9700	4400	10
6295	Single footblock/lockoff	3 1/8	80	4 1/2	114	1 7/16	36	14.4	410	5/8	16	4850	2200	9700	4400	10
6298	Double footblock	3 1/8	80	4 1/2	114	2 9/16	65	20.3	580	5/8	16	3197	1450	6394	2900	10
6299	Single footblock/lockoff/left	3 1/8	80	4 1/2	114	1 7/16	36	14.4	410	5/8	16	4850	2200	9700	4400	10



© Danielle Chandler

BLACK MAGIC AIR BLOCKS

Black Magic Air blocks are a top favorite of Big Boat performance racers and cruisers. These lightweight, free-running, powerful performers are used for sail controls that see lots of action: mainsheet, runner, halyard, and spinnaker systems. Offered in 45 – 150 mm sizes, with low-load versions in 57 and 75 mm ranges.



High-strength, lightweight

- Aluminum sheaves and sideplates.
- CNC sculpted for optimal strength-to-weight.

Stands up to sun, salt, and time

- Sideplates and sheaves Hard Lube-anodized for maximum UV protection and a smooth surface.
- Dissimilar metals isolated to prevent corrosion.

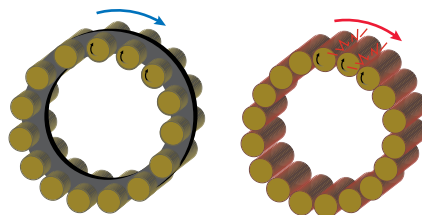

Caged vs. Uncaged Rollers

Low-friction efficiency for fast trim and release

- Center cage keeps Torlon® roller bearings separated and parallel to reduce friction.
- Captive Delrin® ball bearings carry side loads.

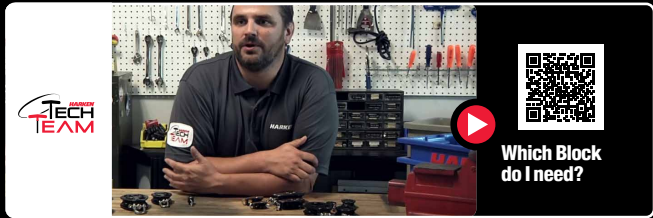
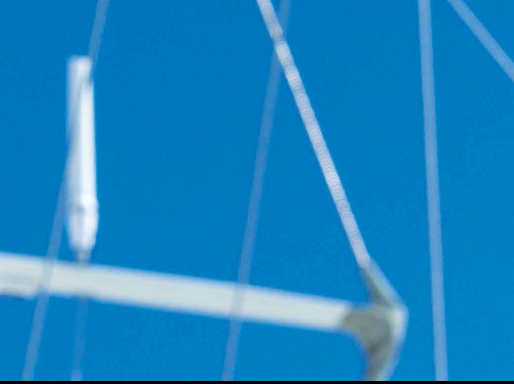

Shackle blocks lock in two directions or swivel to keep line from twisting

- Set screw allows shackle to be fixed or to swivel.



Soft-attach options

- Loop or lash through sheave center instead of block head.
- Sheave center carries primary load, allowing a smaller, lighter weight block.



Soft-attach options

- Patented Loop blocks have a removable dead end post for attachment to a padeye.



6061-T6 aluminum:
Hard Lube-anodized sideplates, sheave

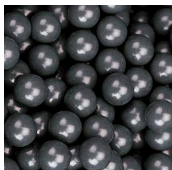

Delrin UV-stabilized:
Ball bearings



Easy maintenance

- Quick disassembly with hex wrench; minimal number of fasteners; no loose balls or rollers.



Torlon:
Caged roller bearings

Materials
For properties see pages 253-254.

45 mm Blocks

About Black Magic Air blocks: see feature pages at beginning of this section.

© J/Boats



3391



3389



3390



3392



3393



3394



3395



3396

Part No.	Description	Sheave Ø		Length		Weight		Shackle pin Ø		Max line Ø		Maximum working load		Breaking load	
		in	mm	in	mm	oz	g	in	mm	in	mm	lb	kg	lb	kg
3389	Single loop**	1 3/4	45	2 1/2	63	2.01	57			3/8	10	1653	750	3306	1500
3390	Double loop**	1 3/4	45	2 1/2	63	3.63	103			3/8	10	1653	750	3306	1500
3391	Single/swivel	1 3/4	45	3 15/16	100	2.79	79	3/16	5	3/8	10	1653	750	3306	1500
3392	Single/swivel/becket	1 3/4	45	4 3/4	120	3.39	96	3/16	5	3/8	10	1653	750	3306	1500
3393	Double/swivel	1 3/4	45	4 3/16	106	6.88	195	1/4	6	3/8	10	2425	1100	4850	2200
3394	Double/swivel/becket	1 3/4	45	3 7/8	99	7.27	206	1/4	6	3/8	10	2425	1100	4850	2200
3395	Single stand-up*	1 3/4	45	3 11/16	94	3.95	112			3/8	10	1653	750	3306	1500
3396	Single runner	1 3/4	45	2 13/16	71	2.89	82	5/16	8	3/8	10	1653	750	3306	1500

*Includes padeye. 5 mm (#10) fasteners, fastener circle: 30 mm (1 3/16"). **Loop not included.

Torlon is a registered trademark of Solvay Advanced Polymers, L.L.C.

57 mm Blocks

About Black Magic Air blocks: see feature pages at beginning of this section.



3226
3215

KM32fc, 9.82 m (32.2'), VPLP design, Magma Composites © Skymny



Low-load blocks have red isolators. They use Torton® rollers and 316 stainless steel shackles. Standard blocks have 17-4 PH stainless headposts.



3214

3216
3229

3387



3217
3228

3218

3219

3227

3386

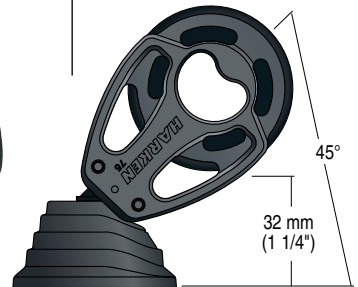

3227

Torton is a registered trademark of Solvay Advanced Polymers, L.L.C.

Part No.	Description	Sheave Ø		Length		Weight		Shackle pin Ø		Max line Ø		Maximum working load		Breaking load	
		in	mm	in	mm	oz	g	in	mm	in	mm	lb	kg	lb	kg
3214	Single loop**	2 1/4	57	3	76	3.23	92			7/16	12	2500	1134	5000	2268
3215	Single/swivel	2 1/4	57	4 11/16	119	5.36	152	1/4	6	7/16	12	2500	1134	5000	2268
3216	Single/swivel/becket	2 1/4	57	5 1/2	140	5.86	166	1/4	6	7/16	12	2500	1134	5000	2268
3217	Double/swivel	2 1/4	57	5 3/16	132	11.86	336	5/16	8	7/16	12	3600	1633	7200	3267
3218	Double/swivel/becket	2 1/4	57	6	152	12.43	352	5/16	8	7/16	12	3600	1633	7200	3267
3219	Triple/swivel	2 1/4	57	5 3/16	132	13.34	378	5/16	8	7/16	12	4850	2200	9700	4400
3226	Single/swivel/low-load	2 1/4	57	4 11/16	119	5.44	154	1/4	6	7/16	12	1655	750	3300	1500
3227	Stand-up*	2 1/4	57	4 1/2	114	7.04	200	1/4	6	7/16	12	2500	1134	5000	2268
3228	Double/swivel/low-load	2 1/4	57	5 3/16	132	12.05	342	5/16	8	7/16	12	2755	1250	5510	2500
3229	Single/swivel/low-load/becket	2 1/4	57	5 1/2	140	5.95	169	1/4	6	7/16	12	1655	750	3300	1500
3386	Double loop**	2 1/4	57	3	76	5.93	168			7/16	12	2500	1134	5000	2268
3387	Single loop/wide sheave**	2 1/4	63	3 1/2	88	6.4	181.3			7/16	12	2500	1134	5000	2268

*Includes padeye. 6 mm (1/4") fastener circle: 37 mm (1 15/32"). **Loop not included. See page 83.

75 mm Blocks

About Black Magic Air blocks: see feature pages at beginning of this section.



3230



Wave Catamaran © Robert Hajduk



The low-load block has a red isolator. It uses Delrin® ball bearings, with a 17-4 PH stainless headpost and 316 stainless steel shackles.

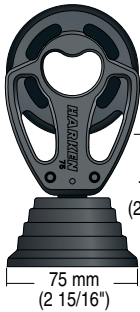

3244

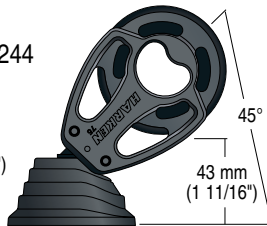

3388



3231
3243



3232



3233



3244



3241



3242

Delrin is a registered trademark of E. I. du Pont de Nemours and Company or its affiliates.

Part No.	Description	Sheave Ø		Length		Weight		Shackle pin Ø		Max line Ø		Maximum working load		Breaking load	
		in	mm	in	mm	oz	g	in	mm	in	mm	lb	kg	lb	kg
3230	Single loop*	2 15/16	75	3 15/16	100	7.36	209			9/16	14	5000	2268	10000	4536
3231	Single/swivel	2 15/16	75	5 1/8	129	11.68	331	5/16	8	9/16	14	5000	2268	10000	4536
3232	Single/swivel/becket	2 15/16	75	6 3/16	157	12.8	363	5/16	8	9/16	14	5000	2268	10000	4536
3233	Double/swivel	2 15/16	75	5 1/4	134	25.44	721	3/8	10	9/16	14	7500	3402	15000	6804
3241	Spriddle/swivel	2 15/16	75	7 13/16	199	17.76	503	5/16	8	9/16	14	5000	2268	10000	4536
3242	Spriddle/swivel/becket	2 15/16	75	8 7/8	225	18.96	538	5/16	8	9/16	14	5000	2268	10000	4536
3243	Single/swivel/low-load	2 15/16	75	5 1/8	129	11.82	335	5/16	8	9/16	14	3000	1361	6000	2722
3244	Stand-up**	2 15/16	75	5 15/16	151	15.6	442			9/16	14	5000	2268	10000	4536
3388	Single loop/wide sheave*	3 1/4	82	4 17/32	116	12.2	346			9/16	2x 14	5000	2268	10000	4536

54 *Loop not included. See page 83. **Includes padeye. Uses hole spacing and base dimensions of 627 padeye. Maximum working load decreases at varying angles, refer to page 87.

100 mm Blocks

About Black Magic Air blocks: see feature pages at beginning of this section.



3248



3246



3247



3245



3211



3254



Deadend post for attachment to a closed bail. Loop not included, see page 85.



Anka4, Solaris 64 RS, 19.5 m (64'), naval architect: Javier Soto Acebal © Solaris Yachts

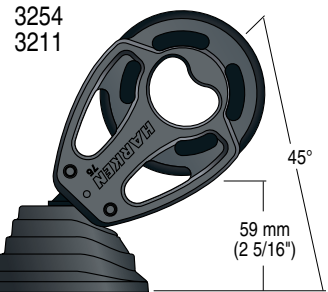

Part No.	Description	Sheave Ø		Length		Weight		Shackle pin Ø		Max line Ø		Maximum working load		Breaking load	
		in	mm	in	mm	oz	g	in	mm	in	mm	lb	kg	lb	kg
3211	Standup/becket**	3 15/16	100	9 1/4	235	32.49	921			5/8	16	7500	3402	15000	6804
3245	Single loop*	3 15/16	100	5 1/16	128	13.09	371			5/8	16	7500	3402	15000	6804
3246	Single/swivel	3 15/16	100	8	203	21.98	623	3/8	10	5/8	16	7500	3402	15000	6804
3247	Single/swivel/becket	3 15/16	100	9 1/2	241	23.82	675	3/8	10	5/8	16	7500	3402	15000	6804
3248	Double/swivel	3 15/16	100	8 15/16	227	45.28	1284	1/2	12	5/8	16	11000	4990	22000	9979
3254	Stand-up**	3 15/16	100	7 11/16	195	31.18	884			5/8	16	7500	3402	15000	6804

*Loop not included. See page 83. **Includes padeye. Uses hole spacing and base dimensions of 648 padeye, refer to page 87.

125 mm & 150 mm Blocks

About Black Magic Air blocks: see feature pages at beginning of this section.



3261

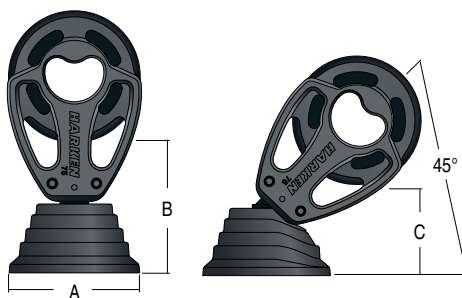

Stand-Up Blocks

Part No.	A		B		C	
	in	mm	in	mm	in	mm
3261	3 21/32	93	4 3/16	106	2 1/4	57
3266	3 3/4	95	5 3/16	132	3 5/8	92



The center becket provides block with additional stiffness for deadending purchases.



Kinina, Swan 78, 23.99 m (78.70'), Germán Frers design © Nautor Swan



3255



3256



3262



3266



3267

Part No.	Description	Sheave Ø		Length		Weight		Shackle pin Ø		Max line Ø		Maximum working load		Breaking load	
		in	mm	in	mm	oz	g	in	mm	in	mm	lb	kg	lb	kg
125 mm															
3255	Single loop*	4 15/16	125	6	163	23.78	674			3/4	19	11000	4990	22000	9979
3256	Single/swivel	4 15/16	125	10	254	37.31	1058	1/2	12	3/4	19	11000	4990	22000	9979
3261	Stand-up**	4 15/16	125	9 1/16	230	44.72	1268			3/4	19	11000	4990	22000	9979
3267	Center becket			2 3/8	60	4.8	136					3667	1663		
150 mm															
3262	Single/swivel	5 15/16	150	12	305	64.9	1840	5/8	16	1	25	15000	6804	30000	13608
3266	Stand-up ‡	5 15/16	150	11 1/8	283	85.34	2419			1	25	15000	6804	30000	13608

*Loop not included. See page 83. **Includes padeye. Uses hole spacing and base dimensions of 648 padeye. Maximum working load decreases at varying angles, refer to page 87.

‡ Uses hole spacing and base dimensions of 629 padeye. Maximum working load decreases at varying angles, refer to page 87.

Air Runner Blocks

Runners are used on running backstays of offshore boats to adjust mast bend for different wind conditions.

Integrated sideplate bails and recessed cotter key help produce a smooth design that won't snag lifelines.

Foam padded Block Socks easily install over Air Runner blocks to protect your blocks, deck, and crew.

About Black Magic Air blocks: see feature pages at beginning of this section.



Sideloading bearing strips dampen rig vibration.



3224
3238
3251
3259
3264



3239
3252
3260
3265



3035
3036
3037
3038

Block Socks

Block Sock Part No.	Fits
3035	3224/3238/3239
3036	3251/3252
3037	3259/3260
3038	3264/3265

Runner Blocks

Part No.	Description	Sheave Ø		Length		Weight		Clevis pin Ø		Max line Ø		Maximum working load		Breaking load	
		in	mm	in	mm	oz	g	in	mm	in	mm	lb	kg	lb	kg
57 mm															
3224	Single	2 1/4	57	3 3/8	86	4.42	125	3/8	10	1/2	12	2500	1134	5000	2268
75 mm															
3238	Single	2 15/16	75	4 5/8	118	10.16	288	1/2	12.7	9/16	14	5000	2268	10000	4536
3239	Single/becket	2 15/16	75	5 3/4	146	11.2	318	1/2	12.7	9/16	14	5000	2268	10000	4536
100 mm															
3251	Single	3 15/16	100	6 3/16	157	17	481	5/8	15.9	5/8	16	7500	3402	15000	6804
3252	Single/becket	3 15/16	100	7 9/16	193	19.12	542	5/8	15.9	5/8	16	7500	3402	15000	6804
125 mm															
3259	Single	4 15/16	125	7 11/16	195	29.76	844	3/4	19	3/4	19	11000	4990	22000	9979
3260	Single/becket	4 15/16	125	9 1/2	240	33.52	950	3/4	19	3/4	19	11000	4990	22000	9979
150 mm															
3264	Single	5 15/16	150	8 3/4	221	50.64	1436	3/4	19	1	25	15000	6804	30000	13608
3265	Single/becket	5 15/16	150	10 13/16	275	56.72	1608	3/4	19	1	25	15000	6804	30000	13608

Crossover Blocks

Crossover blocks provide a cleaner, more efficient deck. These easy-to-install blocks mount behind the stopper bank on each side of the cabin house and can route any line to the winch on the opposite side. Blocks feature built-in risers and sculpted backing plates. The large, strong bases protect cored decks. Use the 1984 for boats to 11.5 m (38') and the 1981 for boats to 15 m (48').



1984
1981

Part No.	Description	Sheave Ø		Base Ø		Height		Weight		Max line Ø		Maximum working load		Breaking load	
		in	mm	in	mm	in	mm	oz	g	in	mm	lb	kg	lb	kg
1981	Crossover	2 3/16	56	2 5/8	66	1 7/16	36	8	227	7/16	12	3000	1361	6000	2722
1984	Crossover	1 3/4	44	2 1/16	52	1 1/4	32	4.2	119	3/8	10	2000	907	4000	1814

Fastener included.

Teardrop Blocks

Teardrop blocks are ideal as masthead leads and in other applications where limited articulation or direct attachment is desired. When attached to a compatible padeye, teardrop blocks will not hit the deck when lines are slack, but allow enough movement to ensure fairleads when jumping halyards. They are often used on permanent backstays of fractionally rigged boats where the backstay can be spliced directly to the head of the block.

About Black Magic Air blocks: see feature pages at beginning of this section.



Part No.	Description	Sheave Ø		Length		Weight		Clevis pin Ø		Max line Ø		Maximum working load		Breaking load		Use padeye
		in	mm	in	mm	oz	g	in	mm	in	mm	lb	kg	lb	kg	
57 mm																
3223	Padeye/high-load	2 1/4	57	3 3/8	86	3.92	111	5/16	8	3/8	10	2500	1134	5000	2268	627
75 mm																
3240	Padeye	2 15/16	75	4 7/16	113	8.72	247	3/8	10	9/16	14	5000	2268	10000	4536	648/689
100 mm																
3253	Padeye	3 15/16	100	5 13/16	148	16	454	1/2	12.7	5/8	16	7500	3402	15000	6804	

Footblocks

Use footblocks to redirect lines on the deck. Footblocks with lockoffs temporarily secure sheets.

Either metric or imperial flathead fasteners may be used for mounting and are not exposed.

About Black Magic Air blocks: see feature pages at beginning of this section.

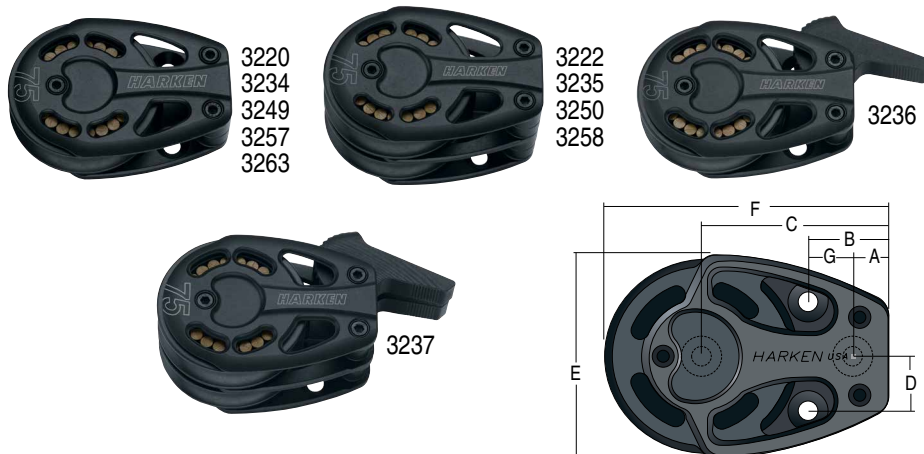

Dimensions

Part No.	A		B		C		D		E		F		G	
	in	mm	in	mm	in	mm	in	mm	in	mm	in	mm	in	mm
3220/3221/3222	3/8	9.5	7/8	22.5	2 1/32	51.5	5/8	16	2 5/16	59	3 5/16	84	1/2	13
3234/3235/3236/3237	15/32	11.5	1 1/8	28.5	2 3/4	70.5	13/16	21	3	77	4 5/16	110	21/32	17
3249/3250	9/16	14.5	1 15/32	37.5	3 21/32	92.5	1 3/32	28	3 15/16	100	5 5/8	143	29/32	23
3257/3258	21/32	17	1 25/32	45	4 7/16	113	1 11/32	34.5	5 1/32	127.5	6 29/32	176	1 3/32	28
3263	13/16	20.5	2 3/32	53.5	5 3/32	129	1 5/8	41	6 1/16	154	8 1/32	204	1 5/16	33

Part No.	Description	Sheave Ø		Length		Height		Weight		Max line Ø		Maximum working load		Breaking load		Fasteners (FH)	
		in	mm	in	mm	in	mm	oz	g	in	mm	lb	kg	lb	kg	pul	mm
57 mm																	
3220	Single/high-load	2 1/4	57	3 5/16	84	1	25	4.29	122	7/16	12	2500	1134	5000	2268	4 x 1/4	4 x 6
3222	Double/high-load	2 1/4	57	3 5/16	84	1 13/16	46	7.6	215	7/16	12	1655	750	3310	1500	4 x 1/4	4 x 6
75 mm																	
3234	Single	2 15/16	75	4 3/8	111	1 1/4	32	9.76	277	9/16	14	5250	2380	10500	4762	4 x 5/16	4 x 8
3235	Double	2 15/16	75	4 3/8	111	2 1/4	57	17.28	490	9/16	14	3465	1572	6930	3143	4 x 5/16	4 x 8
3236	Single/lockoff*	2 15/16	75	4 3/8	111	1 1/4	32	11.28	320	9/16	14	5250	2380	10500	4762	4 x 5/16	4 x 8
3237	Double/lockoff*	2 15/16	75	4 3/8	111	2 1/4	57	20.24	574	9/16	14	3465	1572	6930	3143	4 x 5/16	4 x 8
100 mm																	
3249	Single	3 15/16	100	5 5/8	143	1 5/16	33	19.57	555	5/8	16	7500	3402	15000	6804	4 x 3/8	4 x 10
3250	Double	3 15/16	100	5 5/8	143	2 7/16	62	34.1	967	5/8	16	4950	2250	9900	4500	4 x 3/8	4 x 10
125 mm																	
3257	Single	4 15/16	125	6 15/16	176	1 11/16	43	34.29	972	3/4	19	11000	4990	22000	9979	4 x 1/2	4 x 12
3258	Double	4 15/16	125	6 15/16	176	2 13/16	71.5	60.35	1711	3/4	19	7260	3292	14520	6585	4 x 1/2	4 x 12
150 mm																	
3263	Single	5 15/16	150	8 1/16	205	1 7/8	48	58.58	1661	1	25	15000	6804	30000	13608	4 x 5/8	4 x 16

*Lockoffs are intended to hold lines temporarily and should not be used in place of line stoppers or clutches.

FlatWinder Powered Block

The Harken FlatWinder powered block is a self-contained, low-profile powered system developed for mainsheet traveler adjustment. This powerful block is easy to use and offers sailors huge benefits in mainsail control, giving them the means to quickly depower the rig, and delay reefing when the wind picks up. Like a compact captive winch for the traveler, the FlatWinder is completely self-contained. It operates in both directions allowing the car to move anywhere on the track while also keeping the traveler line off the cockpit floor. FlatWinders can be also used for other applications, like stern platform lifting or foil trimming. Contact Harken Tech Service for more details.

The Flatwinder is available with an electric or hydraulic motor. The compact horizontal motor is housed neatly belowdeck and has a maximum working load of 250/500 kg (550/1100 lb). When used with 10 mm line and a 4:1 purchase, this translates into around 1000 kg (2205 lb) of pull with the FlatWinder 250; 2000 kg (4410 lb) with the FlatWinder 500. The FlatWinder 250 fits monohulls 15 - 18 m (50 - 60') and catamarans 14 - 15 m (45 - 50'); the FlatWinder 500 fits monohulls 18 - 24 m (60 - 80') and catamarans 15 - 20 m (50 - 70').

The FlatWinder is available in 12V, 24V, or 48V electric or hydraulic depending on the boat's system. A Harken Dual-Function Control Box is included with the electric FlatWinders. This integrated load controller and control box conserves space, and with half as many wires as separate systems, is easier to install. Switches and circuit breakers are not included.

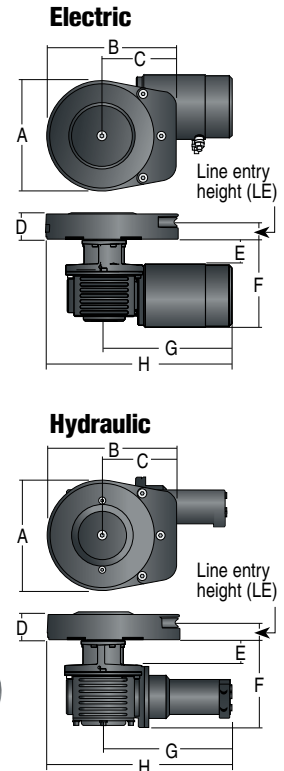

Grand Soleil 58, 17.68 m (58'), Cantiere del Pardo © Fabio Taccola / Grand Soleil



- FW250EA12H
- FW250EA24H
- FW250EA48H
- FW250HA
- FW500EA12H
- FW500EA24H
- FW500EA48H
- FW500HA

Part No.	Description	Weight		Line entry height (LE)		Line Ø		Fastener circle		Fasteners (SH or HH)	Maximum working load		Line speed (no load)	
		lb	kg	in	mm	in	mm	in	mm		mm	mm	lb	kg
FW250EA12H	FlatWinder powered block/12-volt	27.5	12.5	1 1/8	29	3/8	10	4 15/16	125	6 x M6	550	250	115	35
FW250EA24H	FlatWinder powered block/24-volt	27.5	12.5	1 1/8	29	3/8	10	4 15/16	125	6 x M6	550	250	115	35
FW250HA	FlatWinder powered block/hydraulic	24.2	11	1 1/8	29	3/8	10	4 15/16	125	6 x M6	550	250	63	19.2
FW500EA12H	FlatWinder powered block/12-volt	49.6	22.5	1 1/8	29	3/8	10	6 5/16	160	6 x M6	1100	500	85	26
FW500EA24H	FlatWinder powered block/24-volt	49.6	22.5	1 1/8	29	3/8	10	6 5/16	160	6 x M6	1100	500	105	32
FW500HA	FlatWinder powered block/hydraulic	38.5	17.5	1 1/8	29	3/8	10	6 5/16	160	6 x M6	1100	500	41	12.5
FW250EA48H	FlatWinder/48-volt	28.2	12.8	1 1/8	29	3/8	10	4 15/16	125	6 x M6	550	250	72	22
FW500EA48H	FlatWinder/48-volt	53.57	24.3	1 1/8	29	3/8	10	6 5/16	160	6 x M6	1100	500	47	14.3

Dimensions

Part No.	A		B		C		D		E		F		G		H	
	in	mm	in	mm	in	mm	in	mm	in	mm	in	mm	in	mm	in	mm
FW250EA12H	7 9/16	192	8 7/8	226	5 1/8	130	2	51	1 3/4	43	6 1/8	155	8 15/16	227	12 11/16	322
FW250EA24H	7 9/16	192	8 7/8	226	5 1/8	130	2	51	1 3/4	43	6 1/8	155	8 15/16	227	12 11/16	322
FW250HA	7 9/16	192	8 7/8	226	5 1/8	130	2	51	1 13/16	46.5	5 31/32	151.5	8 23/32	221	12 15/32	316.7
FW500EA12H	9 1/2	242	10 3/4	273	6	152	2 1/16	53	2 13/16	71	9 1/8	231	14 5/16	363	19 1/16	484
FW500EA24H	9 1/2	242	10 3/4	273	6	152	2 1/16	53	2 13/16	71	9 1/8	231	14 5/16	363	19 1/16	484
FW500HA	9 1/2	242	10 3/4	273	6	152	2 1/16	53	2 13/16	71	9 1/8	231	11 3/8	289.3	16 5/32	410.2
FW250EA48H	7 9/16	192	8 7/8	226	5 1/8	130	2	51	1 1/2	39	6 1/4	159	9 1/2	241	13 1/4	337
FW500EA48H	9 1/2	242	10 3/4	273	6	152	2 1/16	53	2 13/16	71	9 1/8	231	13 7/8	351	18 1/2	472

Stainless Steel Cruising ESP Blocks



6068
6072



6089
6087



6080



6081



57 mm (2 1/4")
6075

80 mm (3 5/32")
6071

6075
6071



6076
6079



6070
6074

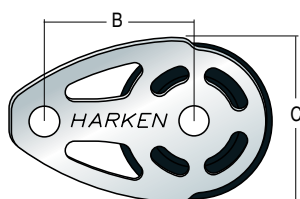

6076, 6079

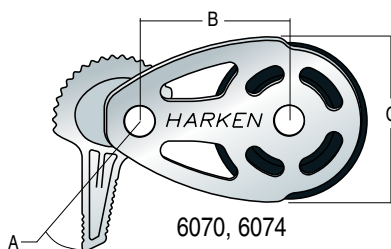

6070, 6074



6069
6073

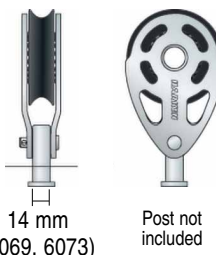

14 mm
(6069, 6073)

Post not included

Dimensions

Part No.	A		B		C	
	in	mm	in	mm	in	mm
6070	1 31/32	50	2 5/32	55	2 1/4	57
6074	2	51	2 1/2	63	2 29/32	74
6076			2 5/32	55	2 1/4	57
6079			2 1/2	63	2 31/32	75

Part No.	Description	Sheave Ø		Length		Weight		Clevis/shackle pin Ø		Max line Ø		Maximum working load		Breaking load‡		Max lockoff load		Fasteners (FH)	
		in	mm	in	mm	oz	g	in	mm	in	mm	lb	kg	lb	kg	lb	kg	in	mm
57 mm																			
6068	Single/swivel	2 1/4	57	5 1/2	140	11	312	5/16	8	5/8	16	2205	1000	4409	2000				
6069	Teardrop mast collar	2 1/4	57	3 11/16	93.5	7	198	5/16	8	5/8	16	2205	1000	4409	2000				
6070	Single foot/lockoff*‡	2 1/4	57	3 3/4	132	9	255			5/8	16	2205	1000	4409	2000	650	295	3/8	10
6076	Footblock‡	2 1/4	57	3 3/4	95	7	198			5/8	16	2205	1000	4409	2000			3/8	10
6089	Single/swivel/becket	2 1/4	57	6 11/16	170	12.5	354	5/16	8	5/8	16	2205	1000	4409	2000				
75 mm																			
6072	Single/swivel	3	75	6 1/4	159	19	539	5/16	8	3/4	19	3500	1587	7000	3175				
6073	Teardrop mast collar	3	75	4 5/8	117	16	454	5/16	8	3/4	19	3000	1361	6000	2722				
6074	Single foot/lockoff*‡	3	75	4 3/8	111	17	482			3/4	19	3500	1587	7000	3175	750	340	3/8	10
6079	Footblock‡	3	75	4 1/2	114	16	454			3/4	19	3500	1587	7000	3175			3/8	10
6080	Fiddle	3;1 13/16	75;46	8 3/8	213	24	680	5/16	8	3/4	19	3500	1587	7000	3175				
6081	Fiddle/becket	3;1 13/16	75;46	9 1/2	241	26.25	744	5/16	8	3/4	19	3500	1587	7000	3175				
6087	Single/swivel/becket	3	75	7 1/4	184	21.25	602	5/16	8	3/4	19	3500	1587	7000	3175				
Deck Organizers																			
6075	Stainless steel 3-sheave ‡	1 9/16	40	7 11/16	179	10	284			1/2	12	3000	1361	6000	2722			5/16	8
6071	Stainless steel 3-sheave ‡	2 1/4	57	9 15/16	252	21	595			5/8	16	6000	2722	12000	5442			3/8	10

*Lockoffs are intended to hold lines temporarily and should not be used in place of line stoppers or clutches.

‡If double stacked, upper block/organizer is two-thirds of listed MWL and breaking load.

Megayacht Blocks

Harken Megayacht blocks have an ultralight composite bearing system (ULC) that rides on a heat-treated stainless steel inner race to handle extremely high loads. Snap-fit Torton® ball bearings carry thrust loads. Sideplates are mirror-polished stainless steel to reflect the traditional beauty of a classic yacht, or hardcoat-anodized 6061-T6 aluminum for strength and corrosion resistance—perfect for performance yachts.

Torton is a registered trademark of Solvay Advanced Polymers L.L.C.

C14457
C14040
C14196
C13771



C14584
C14696
C13911
C14207



Use the hollow inner race as a becket attachment for weight reduction.



HC8670
HC8657
HC8639
HC8635



HC9077
HC9082
HC9087
HC9092



HC8667
HC8640
HC8633
HC8631

HC9078
HC9083
HC9088
HC9093

HC8673
HC8674
HC8675
HC8932



HC9076
HC9081
HC9086
HC9091

C12236
C12237
C12238
C12239



C12242
C12243
C12244
C12245

100, 125, 150 & 175 MM

Stainless Steel Part No.	Aluminum Part No.	Description	Specifications	Imperial	Metric
75 mm					
HC9985		Swivel block	Sheave Ø: Max line Ø: Maximum working load: Breaking load:	2 15/16"	75 mm
HC9986		Stand-up block		9/16"	14 mm
HC9987		Swivel block/becket		5000 lb	2268 kg
HC9990		Teardrop		10000 lb	4536 kg
HC10041		Single footblock			
100 mm					
HC9076	HC8673	Stand-up block	Sheave Ø: Max line Ø: Maximum working load: Breaking load:	3 15/16"	100 mm
HC9077	HC8670	Swivel block		5/8"	16 mm
HC9078	HC8667	Teardrop		11025 lb	5000 kg
C14584	C14457	Single footblock/compact		22050 lb	10000 kg
C12242	C12236	Stud mastbase block			
125 mm					
HC9081	HC8674	Stand-up block	Sheave Ø: Max line Ø: Maximum working load: Breaking load:	4 15/16"	125 mm
HC9082	HC8657	Swivel block		3/4"	19 mm
HC9083	HC8640	Teardrop		15435 lb	7000 kg
C14696	C14040	Single footblock/compact		30870 lb	14000 kg
C12243	C12237	Stud mastbase block			
150 mm					
HC9086	HC8675	Stand-up block	Sheave Ø: Max line Ø: Maximum working load: Breaking load:	5 15/16"	150 mm
HC9087	HC8639	Swivel block*		1"	25 mm
HC9088	HC8633	Teardrop		22050 lb	10000 kg
C13911	C14196	Single footblock/compact		44100 lb	20000 kg
C12244	C12238	Stud mastbase block			
175 mm					
HC9091	HC8932	Stand-up block	Sheave Ø: Max line Ø: Maximum working load: Breaking load:	6 7/8"	175 mm
HC9092	HC8635	Swivel block**		1"	25 mm
HC9093	HC8631	Teardrop		33075 lb	15000 kg
C14207	C13771	Single footblock/compact		66150 lb	30000 kg
C12245	C12239	Stud mastbase block			



HC9985



HC9986



HC9987



HC9990



HC10041

75 MM

*Maximum working load limited by shackle: 8800 kg; 19405 lb.

**Maximum working load limited by shackle: 12800 kg; 28225 lb.

Contact Harken East for custom sizes.

Mastbase Halyard Lead Blocks

Fixed Mastbase Leads

Low-profile mastbase halyard lead blocks are lightweight and can be grouped in a small area at the mastbase. Flared cheeks prevent chafe on the halyards.

The high-load bearing system has a PTFE composite bushing and sideload balls. The sheave is hardcoat-anodized aluminum for additional strength.

Teardrop Mast Collar Blocks

These teardrop mast collar blocks coordinate well with any Harken blocks in a deck layout. Sheaves feature sleeve bearings to handle high static loads and are ideal for halyards. Use the blocks for direct attachment to padeyes, mast collar posts, perforated mast collars, or in mastbase situations where leads might change.



1986



1988
1990
3123
3192



448



Saga, Saare 38.2, 11.4 m (38'), naval architect: Karl-Johan Strahlmann © Saare Yachts OU

FIXED MASTBASE LEADS

Part No.	Clevis pin Ø	
	in	mm
Teardrop Mast Collar Blocks		
6050	5/16	8
6056	5/16	8
6057	3/8	9
6065	5/16	8
6095	1/4	6
6096	1/4	6
6097	5/16	8
6098	9/32	7
6107	1/4	6



TEARDROP MAST COLLAR BLOCKS

Part No.	Description	Sheave Ø		Width		Length		Height		Weight	Max line Ø		Maximum working load		Breaking load		Fasteners required	
		in	mm	in	mm	in	mm	in	mm		oz	g	in	mm	lb	kg		lb
Fixed Halyard Leads																		
448	Halyard lead block	1 1/2	38	7/8	22	2	51	2 1/8	53	2.1	60	3/8	10	300	136	600	272	2
1986	Halyard lead*	1 3/4	44	7/8	22	2 7/8	73	2 1/4	57	3.36	95	3/8	10	750	340	1500	680	2
1988	Mastbase/fixe**	2 1/4	57	1 3/8	35	3 3/16	81	2 7/8	73	6.2	175	3/8	10	2500	1136	5000	2273	3
1990	Mastbase/fixe***	3	76	1 1/4	32	3 13/16	97	3 3/4	95	11.5	326	1/2	12	5000	2273	10000	4545	4
3123	Mastbase/fixe‡	4	102	1 5/8	41	5 1/8	130	5 1/8	130	24.9	708	11/16	18	11000	4990	22000	9980	2
3192	Mastbase/fixe	4	102	1 15/16	50	6 13/16	173	5 1/8	130	35.25	1000	5/8	16	13227	6000	26455	12000	3
Teardrop Mast Collar Blocks																		
6050	Teardrop mast collar	2 1/4	57			3 11/16	93.5			4.3	122	5/8	16	2100	850	4190	1900	
6056	Teardrop mast collar	2 15/16	75			4 5/8	117			7.8	221	3/4	19	3000	1361	6000	2721	
6057	Teardrop padeye block	2 15/16	75			4 11/16	119			8.4	238	3/4	19	3500	1587	7000	3175	
6065	Teardrop padeye block	2 1/4	57			3 11/16	93.5			4.5	128	5/8	16	2100	850	4190	1900	
6095	Teardrop mast collar/low-load	2 1/4	57			3 1/2	89			4	113	5/8	16	1650	748	3300	1497	
6096	Narrow teardrop mast collar	2 1/4	57	2 5/16	59	3 1/2	89			3.3	94	3/8	10	1650	748	3300	1497	
6097	Narrow teardrop mast collar	2 1/4	57	2 5/16	59	3 1/2	89			3.5	99	3/8	10	1650	748	3300	1497	
6098	Narrow teardrop mast collar	3	75	3 1/32	77	4 7/16	113			6.4	181	1/2	12	2500	1134	5000	2268	
6107	Teardrop mast collar	1 9/16	40			2 19/32	65.5			2.2	64	1/2	12	1250	567	2500	1134	

*6 mm (1/4") RH. **6 mm (1/4") FH. ***8 mm (5/16") FH. †16 mm (5/8") HH.

Over-the-Top Blocks

Over-the-top blocks lead lines aft over cabin houses, coamings, and splashguards. They feature high-load sheaves and come in single, double, and triple configurations.



Part No.	Description	Sheave Ø		Width		Length		Height		Weight		Max line Ø		Maximum working load		Breaking load		Fasteners required
		in	mm	in	mm	in	mm	in	mm	oz	g	in	mm	lb	kg	lb	kg	
3002	Single over-the-top*	2 1/4	57	1 3/8	35	3 1/4	83	3 1/4	83	6.4	181	3/8	10	2500	1136	5000	2272	2
3003	Double over-the-top*	2 1/4	57	2 7/16	62	3 1/4	83	3 1/4	83	12.2	346	3/8	10	2500	1136	5000	2272	4
3004	Triple over-the-top*	2 1/4	57	3 1/2	89	3 1/4	83	3 1/4	83	18.1	513	3/8	10	2500	1136	5000	2272	6
C8322	Single over-the-top**	1 3/4	45	1 7/16	36	3 1/16	78	3 7/32	82	5.6	159	1/2	12	2500	1136	5000	2272	2
C8624	Single over-the-top**	2 15/16	75	1 11/16	43	4	101	4	101	18.5	526	9/16	14	5000	2272	10000	4536	3

*6 mm (1/4") FH. **Contact Harken to request quote and lead time.

Flip-Flop Blocks

Low-profile Flip-Flop blocks are lightweight and can be used for various leads on your boat including halyard, mainsheet, and spinnaker sheet leads.

The Flip-Flop block has aluminum hardcoat-anodized sideplates and features Hard Lube-anodized aluminum sheaves for strength and corrosion resistance.

High-load Flip-Flop blocks pivot around the line axis to keep line close to the deck. Hinged construction allows variable leads. Lockoff provides a temporary stop to free up winches.

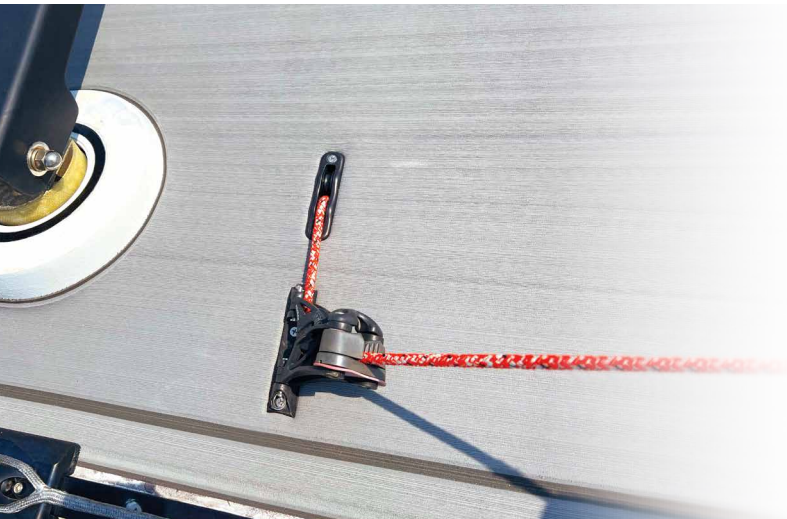
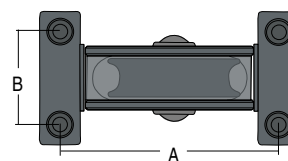

© Skip Mattos

Dimensions

Part No.	Fasteners (SH)		A		B	
	in	mm	in	mm	in	mm
1987/1989	5/16	8	4 15/16	125	1 15/16	50
3122/3194	1/4	6	3 11/16	93.6	1 9/16	39.7

SH cap screw fasteners.

Part No.	Description	Sheave Ø		Width		Length		Height		Weight		Max line Ø		Maximum working load		Breaking load	
		in	mm	in	mm	in	mm	in	mm	oz	g	in	mm	lb	kg	lb	kg
1987	Flip-Flop	3	76	2 7/8	72	6	152	4	100	17.37	493	1/2	12	5000	2273	10000	4545
1989	Flip-Flop/lockoff	3	76	2 7/8	72	6	152	4	100	21.1	598	1/2	12	5000	2273	10000	4545
3122	Flip-Flop	2 1/4	57	2 1/4	57	4 3/8	111	2 7/8	73	9	255	3/8	10	2500	1136	5000	2273

V Blocks

The V block delivers another breakthrough in Harken's loop block series for Grand-Prix racers. Harken engineers have simplified the mechanics by combining the axial and thrust bearings into a single bearing set of V-shaped titanium rollers. The result is a strong, lightweight block that offers unmatched efficiency at high loads, while spinning freely at low loads for smooth easing in light air.

Harken V blocks feature titanium sheaves and captive titanium roller bearings, and are available with either 3D-molded carbon or anodized aluminum sideplates. V blocks are easy to disassemble for inspection and maintenance.

Loop or lash through sheave center instead of block head. Sheave carries primary load, allowing a smaller, lighter weight block.



The V block
What's Inside?



V blocks are named for the unique V-shaped angled rollers that handle both axial and thrust loads.



Designed for easy maintenance, blocks have captive rollers and minimal components; quick disassembly with a hex wrench.



V Blocks



CARBON FIBER



Wide sheave accepts multiple lines for sail changes or a single, high-load larger line that requires a small deflection.



© Bill Faude



ALUMINUM

ALUMINUM WIDE SHEAVE

Part No.	Description	Sheave Ø		Length		Weight		Max line Ø		Maximum working load		Breaking load	
		in	mm	in	mm	oz	g	in	mm	lb	kg	lb	kg
1.5T													
3294	1.5T single loop — Carbon	1 7/8	47	2 19/32	66	2.86	81	11/32	9	3300	1500	6600	3000
3294AL	1.5T single loop — Aluminum	1 7/8	47	2 9/16	65	3.35	95	11/32	9	3300	1500	6600	3000
3366AL	1.5T single loop/wide sheave — Aluminum	1 7/8	47	2 11/16	68	4.27	121	2 x 5/16	2 x 8	3300	1500	6600	3000
3T													
3295	3.0T single loop — Carbon	2 3/16	56	3	77	3.99	113	7/16	11	6600	3000	13200	6000
3295AL	3.0T single loop — Aluminum	2 3/16	56	3	77	4.37	124	7/16	11	6600	3000	13200	6000
3367AL	3.0T single loop/wide sheave — Aluminum	2 3/16	56	3	77	6.24	177	2 x 3/8	2 x 10	6600	3000	13200	6000
5T													
3296	5.0T single loop — Carbon	2 7/16	62	3 5/16	84	6.31	179	1/2	13	11000	5000	22000	10000
3296AL	5.0T single loop — Aluminum	2 7/16	62	3 5/16	84	6.74	191	1/2	13	11000	5000	22000	10000
3362AL	5.0T single loop/wide sheave — Aluminum	2 7/16	62	3 3/4	94	9.17	260	2 x 1/2	2 x 13	11000	5000	22000	10000
6.5T													
3297	6.5T single loop — Carbon	3 1/4	82	4 3/16	107	12.84	364	5/8	16	14300	6500	28600	13000
3297AL	6.5T single loop — Aluminum	3 1/4	82	4 3/16	107	14.11	400	5/8	16	14300	6500	28600	13000
3368AL	6.5T single loop/wide sheave — Aluminum	3 1/4	82	4 5/8	118	18.13	514	2 x 5/8	2 x 16	14300	6500	28600	13000
8T													
3363AL	8.0T single loop — Aluminum	4 3/32	104	5 3/8	136	25.12	712	11/16	18	17600	8000	35200	16000
3369AL	8.0T single loop/wide sheave — Aluminum	4 3/32	104	5 9/16	141	31.57	895	2 x 11/16	2 x 18	17600	8000	35200	16000
12T													
3370AL	12T single loop — Aluminum	4 3/4	120	6 3/16	157	33.23	942	7/8	22	26400	12000	52800	24000
C14730	12T single loop/wide — Aluminum	4 3/4	120	6 19/32	168	47.61	1350	7/8	22	26400	12000	52800	24000
16T													
3371AL	16T single loop — Aluminum	5 5/16	135	6 15/16	175	42.54	1206	1 1/32	26	35200	16000	70400	32000
C14951	16T single loop/wide — Aluminum	5 5/16	135	7 5/16	188	60	1.7	1 1/32	26	35200	16000	70400	32000
20T													
3372AL	20T single loop — Aluminum	6 1/8	155	7 27/32	199	62.72	1700	1 3/16	30	44000	20000	88000	40000
C15203	20T single loop/wide — Aluminum	6 1/8	175	8 7/8	225	88.9	2520	1 1/3	34	44000	20000	88000	40000

Loops not included. *Carbon **Aluminum

High-Load Snatch Blocks

These multipurpose blocks are a must on racing yachts of all sizes. Opening sideplates make them easy to deploy, allowing crew to quickly fasten them wherever needed—perfect for temporary leads, line deflection, and static line functions requiring small adjustments. A strop soft-attach is fixed on one side, but is easily removable on the other. The strop carries the block's primary load and articulates for a fair lead. The Velcro® strap is permanently attached to one sideplate and holds the block securely closed when sideplates are aligned—even under the highest loads. The strap has a broad reflective tab for easier operation with gloves.

Harken composite bearing technology (ULC) ensures sheaves turn smoothly and maintain efficiency under extreme loading. Snap-fit Torlon® bearings carry sideloads. An integral headspacer prevents Hard Lube-anodized aluminum sideplates from deflecting and binding. The wide sheave allows a range of line diameters.

Torlon is a registered trademark of Solvay Advanced Polymers L.L.C.

Velcro is a registered trademark of Velcro Industries B.V.I.



Sideplate rotates open allowing rigged line to be loaded into block.



A fixed Velcro strap keeps sideplates aligned and securely closed under high loads.



3299

3300

3301

3302

3303

Part No.	Description	Sheave Ø		Length		Weight		Max line Ø		Maximum working load		Breaking load	
		in	mm	in	mm	oz	g	in	mm	lb	kg	lb	kg
3299	2.3T snatch	1 1/2	38.5	2 1/2	63	2.9	84	7/16	11	5069	2300	10138	4600
3300	5T snatch	2 1/5	56	3 2/5	86	8.9	252	5/8	16	11020	5000	22040	10000
3301	8T snatch	3	75	4 1/2	114	17.6	498	3/4	18	17632	8000	35264	16000
3302	12T snatch	4	101	5 4/5	148	36.7	1041	1 3/16	30	26448	12000	52896	24000
3303	15T snatch	4 9/10	125	6 9/10	175	58.3	1654	1 3/16	30	33060	15000	66120	30000

One Ton Twing Block

The new Twing block features a spring-loaded side-opening mechanism for true one-handed rigging, even while wearing sailing gloves. Black anodized aluminum sideplates are edged with robust bumpers to protect the block, topsides, and deck. The sheave is aluminum rolling on a bearing system shared with Harken's existing 2.3T high-load snatch block.



3405

Part No.	Description	Sheave Ø		Length		Weight		Max line Ø		Maximum working load		Breaking load	
		in	mm	in	mm	oz	g	in	mm	lb	kg	lb	kg
3405	1T Twing block	1 1/2	38.5	3.0	78	1.4	143	.43	11	2205	1000	4409	2000



COMPLEMENTARY
HARDWARE



NEW FOR 2024

Bolt-Down Fairlead
SEE PAGE 92





ClubSwan 36, 11 m (36'), naval architect: Juan Kouyoumdjian ©
Nautor's Swan/Studio Borlenghi/Stefano Gattini



BALL BEARING CAM CLEATS

Multiple rows of high-load ball bearings and precise V-shape reduce friction, allowing Harken cam cleats to activate with the snap of the wrist. No need for draw-through cleating: a downward flick snaps the sheet into the cam and stays exactly where you put it. Flick up and the cleat releases instantly, even under high loads. Harken cleats are the only cleats that engage under maximum line tension.



Cams engage/release loaded line instantly for precise sail control

- Multiple rows of UV-stabilized ball bearings reduce friction.
- Cam horns and V-shape for easy line entry.

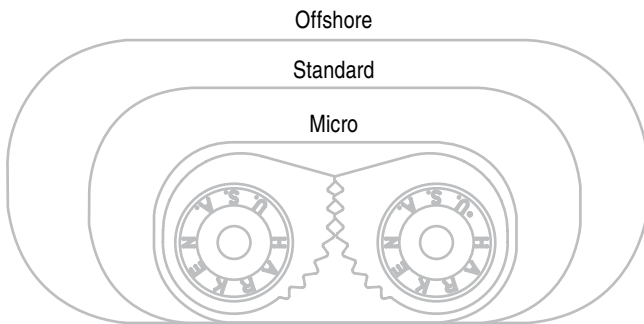

Three sizes in lightweight, wear-resistant materials

- Micro, standard, offshore sizes.
- Cam-Matic: Hard Lube-anodized aluminum, or mirror-polished stainless steel.
- Carbo-Cam: UV-stabilized fiber-reinforced Carbo composite.



Rebuild your
Harken 150
Cam-Matic
Cam Cleat

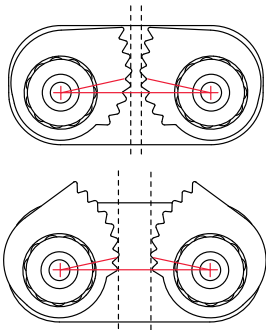

Protective tooth design holds line securely

- Rounded teeth reduce line wear, squeezing rather than cutting the line.
- Each line size held by the most number of teeth.



Full range of accessories

- Flairleads, fairleads, adapter plate, wedge kits, risers, and bases.



Materials
For properties see
pages 253-254.



316 Stainless steel:
Mirror-polished



6061-T6 aluminum:
Hard Lube-anodized



Carbo composite:
UV-stabilized

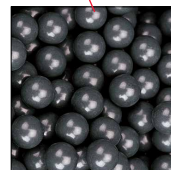

Delrin® UV-stabilized:
Ball bearings

Ball Bearing Cam Cleats



CAM-MATIC



CARBO-CAM



CAM-MATIC

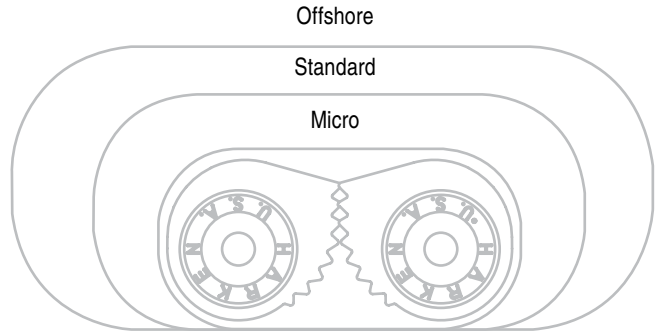

Part No.	Description	Height		Length		Width		Weight oz	Weight g	Line Ø			Fastener spacing in	Fastener spacing mm	Maximum working load		Breaking load		Pawls	
		in	mm	in	mm	in	mm			in	mm	in			mm	lb	kg	lb		kg
150	Cam-Matic*	1 3/16	30	2 9/16	65	1 1/4	32	2.5	71	1/8	3	1/2	12	1 1/2	38	300	136	750	340	Aluminum
280	Offshore Cam-Matic‡	1 7/16	37	3 3/8	85	1 1/2	38	5.25	148	1/4	6	5/8	16	2 1/16	52	500	227	1000	454	Aluminum
468	Micro Cam-Matic**	7/8	22	1 7/8	48	15/16	24	0.93	26	3/32	2	1/4	6	1 1/16	27	200	91	400	181	Aluminum
491	Offshore Cam-Matic SS ‡	1 7/16	37	3 3/8	85	1 1/2	38	13.4	380	1/4	6	5/8	16	2 1/16	52	500	227	1000	454	Stainless steel
365	Carbo-Cam*	1 3/16	30	2 9/16	65	1 1/4	32	1.44	42	1/8	3	3/8	10	1 1/2	38	200	91	500	227	Plastic carbon-matrix
412	Double Cam-Matic*	2 1/16	53	3 17/32	81	1 1/4	32	4.5	126	5/16	8	3/8	10	2 7/16	62	500	227	750	340	Aluminum
471	Micro Carbo-Cam**	7/8	22	1 7/8	48	15/16	24	0.67	19	1/8	3	1/4	6	1 1/16	27	150	68	300	136	Plastic carbon-matrix

*#10 (5 mm) FH fasteners. **#8 (4 mm) RH fasteners. ‡6 mm (1/4") FH fasteners.

Cam Kits



Part No.	Description	Cam	Wedge	Fairlead	Weight oz	Weight g
Micro Kits						
472	Carbo-Cam/wedge/wire fairlead	471	297	475	1.2	33
469	Cam-Matic/wire fairlead	468		475	1.2	33
473	Carbo-Cam/wire fairlead	471		475	0.9	26
474	Carbo-Cam/X-Treme Angle Fairlead	471		476	1.7	47
470	Cam-Matic/X-Treme Angle Fairlead	468		476	1.9	55
498	Cam-Matic/Fast Release Fairlead	468		495	1.8	52
499	Carbo-Cam/Fast Release Fairlead	471		495	1.5	43
Standard Kits						
326	Carbo-Cam/wire fairlead	365		298	2	54
327	Cam-Matic/wire fairlead	150		298	3	85
458	Carbo-Cam/X-Treme Angle Fairlead	365		375	3.36	98
459	Cam-Matic/X-Treme Angle Fairlead	150		375	4.42	127
496	Cam-Matic/Fast Release Fairlead	150		494	4.85	137
497	Carbo-Cam/Fast Release Fairlead	365		494	3.53	100

Cam Cleat Accessories

Use these accessories to adapt our cleats for many applications, such as cleaning up cockpit controls with color-coding or leading a line cleanly to a cleat.

The 475 Micro Cam-Matic cleat and 298 wire fairleads guide line into the entrance side of the cleat, maintaining a low profile and holding line close to the cleat.

Use the 475 with the 468 and 471 Micro Cam-Matic cleats. Use the 298 wire fairlead with the 150 Cam-Matic and 365 Carbo-Cam cleats.

The 494 and 495 Fast Release Fairleads feature low-friction, angled stainless steel line guides on the exit side of the cleat. The angled lead keeps the line away from the cam to eliminate unexpected recleats during maneuvers. Use for fast spinnaker take-downs during mark roundings—anywhere fast release is crucial. Harken Cam-Matic Fairleads are made of tough, abrasion-resistant composite.

Use the 495 with 468 and 471 Micro Cam-Matic cleats; the 494 fairlead with the 150 Cam-Matic and 365 Carbo-Cam cleats.

The 375 X-Treme Angle Fairlead uses low-friction stainless steel line guides on the exit side of the cleat. This allows crew to release and recleat at angles up to 90 degrees to the cleat without centering the line. Perfect for cabintop controls and adjusting deck cleats from the rail. A must for fine-tuning Laser outhaul and cunningham controls. Harken Cam-Matic Fairleads are made of tough, abrasion-resistant composite. Use the 476 X-Treme Angle Fairlead with the 468 and 471 Micro Cam-Matic cleats; the 375 X-Treme Angle Fairlead with the 150 Cam-Matic and 365 Carbo-Cam cleats.

The 424 and 425 low-profile, top-mounted Fairleads can also be used to guide lines. They feature stainless wearguards and are available in various colors for color coding cams. Use the 424 with the 468 and 471 Micro Cam-Matic cleats. Use the 425 with the 150 Cam-Matic and 365 Carbo-Cam cleats.

Wedge kits and risers improve the angle of your cams. A range of eyestraps holds line at the cleat and provides fair leads.



Cleat and uncleat at angles up to 90 degrees.

Stainless steel loop provides low-friction turning post.

Base plate ensures optimal cleating height.

Ideal for Laser outhaul/cunningham controls.



Part No.	Description	Height above cam		Height		Length		Width		Weight		Fastener spacing		Fits
		in	mm	in	mm	in	mm	in	mm	oz	g	in	mm	
Micro														
281.PAIR	Eyestrap (pair)	1/2	12			1 7/16	36	7/16	11	.16	4.5	1 1/16	27	468/471
475	Wire fairlead			15/16	23	1 7/8	48	15/16	24	.29	8	1 1/16	27	468/471
293	Flat cam riser			5/8	16	1 7/8	48	15/16	24	.5	14	1 1/16	27	468/471
294	15° angled micro cam riser			3/4	19	1 7/8	48	15/16	24	.75	21	1 1/16	27	468/471
297	Cam wedge kit					1 7/8	48	15/16	24	.16	5	1 1/16	27	468/471
476	X-Treme Angle Fairlead	7/8	22	1 7/16	37	1 5/16	33	2	51	1	29	1 1/16	27	468/471
424	Flairlead‡‡	7/16	11			1 5/8	41	5/8	16	.13	3.5	1 1/16	27	468/471
495	Fast Release Fairlead	9/16	14	1 9/16	40	1 5/16	33	1 15/16	49	.92	26	1 1/16	27	468/471
Standard														
145	Cam wedge kit					2 9/16	65	1 1/4	32	1	28	1 1/2	38	150/365
201.PAIR	Low-profile eyestrap (pair)	3/8	10			1 7/8	48	7/16	11	.16	4.5	1 1/2	38	150/365
295	Flat cam riser			1	24	2 9/16	65	1 1/4	32	1.5	38	1 1/2	38	150/365
296	15° angled cam riser			1 1/16	27	2 9/16	65	1 1/4	32	1.25	35	1 1/2	38	150/365
298	Wire fairlead			1 1/4	32	2 9/16	65	1 1/4	32	.5	14	1 1/2	38	150/365
375	X-Treme Angle Fairlead‡	15/16	24	2 1/4	57	1 13/16	46	2 9/16	65	1.92	56	1 1/2	38	150/365
425	Flairlead‡‡	5/8	16			2 3/16	56	1 3/16	21	.25	7	1 1/2	38	150/365
438	Cam adapter plate			9/16	14	3	76	1 7/16	36	2.5	71	1 1/2	38	150/365
494	Fast Release Fairlead	3/4	19	2 3/32	53	1 13/16	47	2 5/8	67	2.12	60	1 1/2	38	150/365
Offshore														
282.PAIR	Large eyestrap (pair)	15/16	23			2 13/16	71	3/4	19	.8	23	2 1/16	52	280
283	Offshore cam wedge kit					3 3/8	85	1 1/2	38	1.5	43	2 1/16	52	280
137.PAIR	Eyestrap (pair)	3/4	19			2	51	9/16	14	.32	9	1 1/2	38	150/365

‡Max line Ø: 10 mm (3/8"). ‡‡Indicate color: BL (blue), Y (yellow), G (green), B (black), R (red).

Cam Cleat Accessories

Micro

Standard

Offshore



424
425

Lightweight, fiber-reinforced Flairleads feature stainless wearguards for long life and are available in various colors for color-coding cams.



297



145



283

Wedge kits and risers are available to improve cam angles. Underdeck shims are included with angled risers and wedges for easy mounting.



294



296



293



295



475

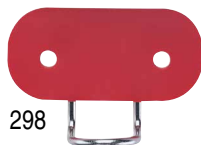

298



476



375



495



494



424



425



281.PAIR



137.PAIR



201.PAIR



282.PAIR



438

The 438 adapter plate is perfect for use on masts and booms. It raises the cleat off the mast to improve the cleating angle and control.

Cam Bases

Use cam swivel bases when leads must rotate to face the trimmer.

Ball bearing swivel bases feature dual rows of Delrin® ball bearings that swivel freely even under high loads. Bases include stand-up springs and a U-Adaptor to accept a variety of appropriate blocks.

The 144 is the standard configuration with a tall arm. It is ideal for mounting in the cockpit or for use on larger keelboats and small offshore boats that use 76 mm (3") plastic blocks. The low-profile 205 is used when installation is at deck level and when smaller blocks are used. The 1574 accepts Midrange blocks.

The 216 features a second cleat for lines led vertically through the base of the swivel. It is frequently used to combine vang or backstay controls in the same swivel base that handles the mainsheet.

The 240, 241 and 639 are simple swivel bases for main and jib sheets on very small boats or for control lines on boats of all sizes.

The 402 and 403 are fitted with a double Cam-Matic cleat for use in 2-speed mainsheet systems.

The 9051 and 9052 adjustable cam swivel base with 468 Micro Cam-Matic cleat provides precise cleating. The cleating angle adjusts infinitely in a 5-17 degree range up and down for optimal line lead. In the 9051 the 16 mm sheaves feature low-friction stainless steel ball bearings to handle high loads, ideal for controls where cleating angles change dramatically.

Delrin is a registered trademark of E. I. du Pont de Nemours and Company or its affiliates.



Cam-Matic ball bearing cam cleats.

Swivels freely under load.

Stops on base prevent swivel from over-rotating and fouling line.

144 includes adapter for 57 mm and 75 mm Carbo blocks.

Loosen screws to adjust 9051/9052 cam angle.



Part No.	Description	Height		Weight		Line Ø			Fastener spacing		Maximum working load		Use with
		in	mm	oz	g	Min	Max	in	mm	in	mm	lb	
144	Swivel base/150 Cam-Matic*	5 3/4	146	13	369	1/8	3 1/2	12	3/4	19			57 mm/75 mm/2.25"/3.00"/ratchets
205	Small swivel base/150 Cam-Matic*	4 1/2	114	12	340	1/8	3 1/2	12	3/4	19			57 mm/Big Bullet/Dinghy/2.25"/small ratchets
216	Duocam swivel base/365, 471 Carbo-Cam*	5 3/4	146	16	454				3/4	19			57 mm/2.25"/3.00"/ratchets
238	150 Cam-Matic on plate/bullseye‡	1 5/16	33	4	113	1/8	3 1/2	12	1 1/2, 1	38, 25	300	136	
239	365 Carbo-Cam on plate/bullseye‡	1 5/16	33	3	85	1/8	3 3/8	10	1 1/2, 1	38, 25	200	91	
240	Bullseye swivel base/150 Cam-Matic*	2 7/16	62	7.5	213	1/8	3 1/2	12	1 1/32	26	300	136	
241	Bullseye swivel base/365 Carbo-Cam*	2 7/16	62	6.5	184	1/8	3 3/8	10	1 1/32	26	150	68	
379	471 Micro Carbo-Cam on plate/bullseye‡‡	7/8	22	1.75	50	1/8	3 1/4	6	1 1/16	27	150	68	
402	Small swivel base/412 Cam-Matic*	4 3/8	111	12.75	362	5/16	8 3/8	10	3/4	19			57 mm/2.25" double ratchets
403	Swivel base/412 Cam-Matic*	5 3/4	146	14	398	5/16	8 3/8	10	3/4	19			57 mm/2.25"/3.00" double ratchets
639	Bullseye swivel base/150 Cam-Matic*	1 15/16	75	9.14	259	1/8	3 1/2	12	1 1/32	26	300	136	
1574	Midrange swivel base/280 Cam-Matic**	5 15/16	151	23	652	1/4	6 5/8	16	1 1/16	27			Midrange
HSB538	Swivel base/471 Micro Carbo-Cam/Bullseye	1 13/16	46	3.7	105	1/8	3 1/4	6	1 1/32	26	150	68	
9051	Swivel base/468 Micro Cam-Matic/16 mm sheaves	2 3/8	60	6.1	173	1/8	3 1/4	6	1 1/32	26	200	91	
9052	Swivel base/468 Micro Cam-Matic/Bullseye	2 3/8	60	5.6	160	1/8	3 1/4	6	1 1/32	26	200	91	

*#10 (5 mm) FH fastener. **6 mm (1/4") FH fastener. ‡#10 (5 mm) RH fastener. ‡‡#8 (4 mm) RH fastener.

Stand-Up Bases

Stand-up bases allow a wide variety of blocks to be held upright, swivel freely, or pivot so lines have a fair lead under load.

Ball-and-Socket Swivel Bases

The ball-and-socket design lets blocks articulate up to 45 degrees and swivel freely. The 460 and 461 bases have stainless steel reinforcement plates to handle the high load capacities of 57 mm and 75 mm Carbo blocks. Bases may be fitted with springs, but blocks won't hit the deck without them.

Stanchion Mount Base

The 061 stanchion mount base attaches blocks to 22 mm or 25 mm (7/8" or 1") stanchions or pulpits and is often used to lead furling lines to the cockpit. Allows blocks to swivel and pivot for fairleads.

Midrange Cruising ESP Stand-Up

Use the 1634 stand-up base with Midrange blocks and 57 mm or 75 mm Cruising ESP blocks. Block head-post fits into socket without shackle. The low-profile design is ideal for mastbase and halyard lead blocks.

Springs

Springs support blocks on padeyes, eyestraps, bases, and traveler cars, and prevent blocks from hitting the deck.

Stand-Up Boots

Made of durable, flexible PVC, stand-up boots hold blocks up without snagging lines. The 369 fits 40 mm and 57 mm Carbo and Black Magic blocks. The 370 fits 75 mm Carbo blocks.

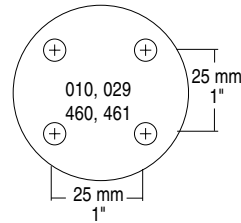
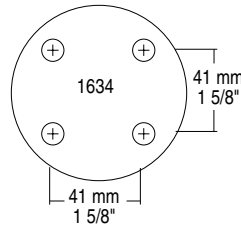

1634



1634: Midrange and ESP Cruising block stand-up base

Swivels and pivots freely

Blocks will not hit deck



460
461



061

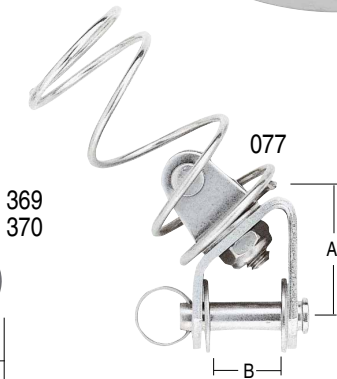

077



097.PAIR
071.PAIR
1603.PAIR



010

Bases

Part No.	Description	Height		Weight		Base	Inside socket	Pin	Maximum working load	Breaking load		Use with				
		in	mm	oz	g	Ø	Ø	Ø		lb	kg					
010	Ball/socket*	1 3/4	44	3	85	2 1/8	54	3/8	10	3/16	5	400	181	1300	590	2.25"/Little Fiddle/ratchets
061	Stanchion mount base	1 1/4	32	2	57			3/8	10	3/16	5	350	159			Bullet/Big Bullet/2.25"/ratchets
460	Ball/socket/high-load*	1 3/4	44	4	113	2 1/8	54	3/8	10	3/16	5	800	363	2500	1134	57 mm Carbo
461	Large ball/socket/high-load*	2	51	4.5	128	2 1/8	54	7/16	12	1/4	6	1000	454	2500	1134	75 mm Carbo
1634	Midrange/Cruising ESP stand-up**	1 15/16	49	9	255	2 7/8	73	9/16	15	5/16	8	3500	1588	7000	3175	Midrange/Cruising ESP

Base accessories

Part No.	Description	Weight		A		B		Shackle pin Ø	
		oz	g	in	mm	in	mm	in	mm
071.PAIR	Stand-up spring (pair)	.32	9.1	2	51	7/8	22		
077	DN adapter	2.4	69	1/4	32	11/16	17	3/16	5
097.PAIR	Small stand-up spring (pair)	.13	3.7	1	25	3/4	19		
369	Small stand-up boot	.45	12.7	2	51	1 9/16	40		
370	Large stand-up boot	1.1	30.8	2 5/8	67	2 3/16	55		
1603.PAIR	Midrange stand-up spring (pair)	.74	21	2 1/2	64	1 3/8	35		

*#10 (5 mm) FH fasteners. ** 6 mm (1/4") RH fasteners.

Accessories

Accessories are designed to make standard blocks more versatile or fill a special need. Custom products available on website.

Handhold

The 062 handhold is popular on boats like Solings and scows to help hiking crew reenter the boat. It can also be used as a handle for things like engine covers. It has drain holes.

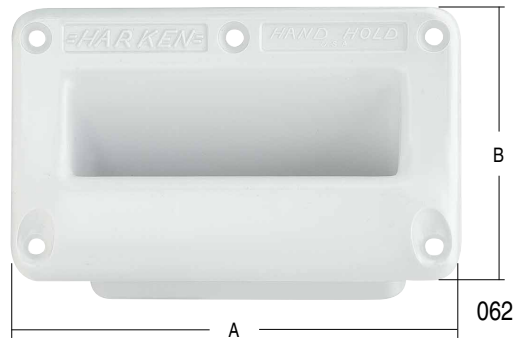

Bullseye Fairlead

Use the 237 and 339 where there is little deflection in the line such as routing a spinnaker pole foreguy aft along the cabin house.

Sail Chafe Protectors

Use the 285 to ease genoas over lifelines or past shrouds and to help large roach mainsails clear backstays.

Prefeeder

Use 947 with racing foils or furling systems.

Dinghy Clew Hook

The 433 and 394 dinghy clew hooks are designed for Lasers and other loose-footed dinghies. They install permanently on the boom and allow you to instantly attach and adjust your sail in high wind and waves.

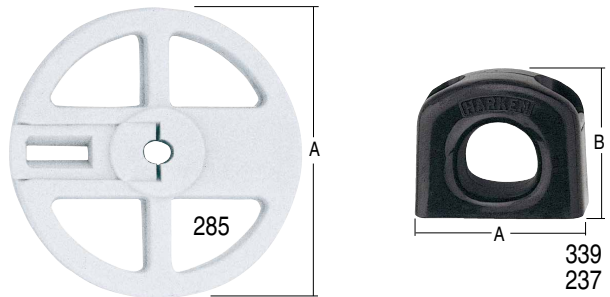

© US Sailing Team / Sailing Energy

Part No.	Description	A		B		Fastener spacing		Part No.	Description	Weight	
		in	mm	in	mm	in	mm			oz	g
062	Handhold*	5 3/4	146	3 1/2	89			394	Dinghy clew hook/404	1	28.4
237	Bullseye fairlead**	1 1/4	32	1 1/2	38	1	25.4	433	Dinghy clew hook	.65	18.4
285	Sail chafe protector set (2)	2 3/4	70					947	Prefeeder	1	28
339	Micro bullseye fairlead‡	1 1/16	27	3/4	19	.71	18				

*#10 (5 mm) FH fasteners. **#10 (5 mm) RH fasteners. ‡#8 (4 mm) RH fasteners, max line Ø 6 mm (1/4").

Self-Contained Sheaves

Self-contained sheaves are designed for sailors to use in custom applications.

The Micro, Bullet, and Big Bullet sheaves are Delrin with Delrin® ball bearings. They are scored for rope. 16 mm sheaves are Delrin and feature stainless ball bearings that ride in a grooved race. Midrange sheaves come in either Delrin or aluminum for wire.

Wire sheaves are Hard Lube-anodized aluminum that ride on high-load composite bearings.

Ball bearings in the 38 mm (1 1/2") and 51 mm (2") sheaves minimize friction. The 25 mm (1") wire sheave uses low-friction washers for this purpose.

Two 160 sheaves make up the 161 dual-sheave universal lead. Use this sheave to divert a line that must turn in either direction.

Use Cruising ESP sheaves to handle high static loads from halyards and reef lines. Sheaves are carbon-black Delrin for UV-protection and turn on stainless steel spacers. Contained sideload ball bearings allow sheaves to spin freely when loads are released. Sheaves require a sideplate for the sideload balls to roll on.

Use for:

Custom applications



160



277



415

Ball bearings handle low loads and sideloads from unfair leads.

Plastic sleeve bearing for high static loads



161



265



2760



6062



6063



6064



1533
1534



303



307



311

Jeanneau 51 © Jeanneau

Part No.	Description	Sheave Ø		Width		Weight		Center pin Ø		Max Ø		Wire		Maximum working load	
		in	mm	in	mm	oz	g	in	mm	Line in	mm	in	mm	lb	kg
160	29 mm	1 1/8	29	1/2	12	0.25	7	1/4	6.27	5/16	8			300	136
161	29 mm	1 1/8	29	7/8	22	1	28	1/4	6.27	5/16	8			300	136
265	38 mm	1 1/2	38	9/16	14	.5	14	1/4	6.27	3/8	10			300	136
277	22 mm	7/8	22	13/32	10	0.1	3	3/16	4.75	1/4	6			200	91
303	25 mm	1	25	9/32	7	0.25	7	3/16	4.75	5/32	4	3/32	2	1000	454
307	38 mm	1 1/2	38	13/32	10	1	28	1/4	6.27	3/16	5	1/8	3	1500	680
311	51 mm	2	51	13/32	10	1.5	43	5/16	8.1	1/4	6	3/16	5	2000	907
415	16 mm	5/8	16	5/16	8	0.13	4	3/16	4.75	3/16	5			250	113
1533	51 mm	2	51	7/8	22	1.5	43	1/4	6.27	5/8	16			500	227
1534	51 mm/aluminum	2	51	7/8	22	2.5	71	1/4	6.27	5/8	16	3/16	5	500	227
2760	57 mm	2 1/4	57	5/8	15	.88	25	1/4	6.27	3/8	10			300	136
6062	40 mm	1 9/16	40	11/16	17	0.8	23	5/16	8.1	1/2	12			1250	567
6063	57 mm	2 1/4	57	13/16	21	1.6	46	3/8	10	5/8	16			2500	1134
6064	75 mm	2 15/16	75	7/8	22	4.4	126	3/8	10	3/4	19			3500	1588

Delrin is a registered trademark of E. I. du Pont de Nemours and Company or its affiliates.

Big Boat Sheaves

Big Boat sheaves are available for special applications as well as for replacement sheaves in Big Boat blocks. Made of Hard Lube-anodized, 6061-T6 aluminum, sheaves feature Torton® rollers to carry high radial loads and carbon-black Delrin® ball bearings to support sideloads and provide UV-protection. Select sheaves based on load-carrying capability.

Installation requires clamping or securing inner race.

Use for:

- Mainsheets
- Spinnaker sheets
- Afterguy/foreguy
- Footblocks



Torton roller/ball bearing system

Hard Lube-anodized
6061-T6 aluminum

Carbon-black balls for UV-protection



Xp 55, X-Yachts © X-Yachts



500



603



1539



518
519
520



657



550

Part No.	Sheave Ø		Width		Weight		Center pin Ø		Fasteners		Fastener circle		Max line Ø		Maximum working load		Breaking load	
	in	mm	in	mm	oz	g	in	mm	in	mm	in	mm	in	mm	lb	kg	lb	kg
500	3	76	7/8	22	6	170	3/8	10	3/8	10			9/16	14	4950	2245	9900	4490
518	4 1/2	114	1	25	16	454	3/4	19.1	3/8	10	1 3/8	35	3/4	18	7500	3401	15000	6803
519	5 1/2	140	1 1/8	29	27	765	7/8	22.28	3/8	10	1 5/8	41	7/8	22	9100	4127	18200	8254
520	7	178	1 1/8	29	45	1280	1 1/2	38	1/2	12	2 1/2	64	7/8	22	14000	6349	28000	12698
550	4	102	7/8	22	10	284	3/8	10	3/8	10			9/16	14	4950	2245	9900	4490
603	3	76	1 9/16	40	10	284	3/8	10	3/8	10			3/4	18	4950	2245	9900	4490
657	4 1/2	114	1 5/8	41	25	709	3/4	19.1	3/8	10	1 3/8	35	7/8	18	14850	6736	29700	13472
1539	2 1/2	64	1 3/8	35	7	198	5/16	8.1	5/16	8			1/2	12	3000	1361	6000	2721

Delrin is a registered trademark of E. I. du Pont de Nemours and Company or its affiliates.
Torton is a registered trademark of Solvay Advanced Polymers, L.L.C.

V Sheaves

High-load titanium V sheaves feature the same incredibly efficient bearing set of angled titanium rollers as Harken's V blocks. Harken V sheaves are extremely versatile! Perfect for running lines underdeck, in mainsheet and spinnaker sheet or drop line systems. They are also perfect to rig clean backstay systems to steady today's slender masts and adjust most bend. Snap fit Delrin® side covers require no tools to disassemble for maintenance.

V sheaves are available in 1.5T to 20T sizes, labeled with working loads. Use the wide sheave for two-sheet peels. Use the wide tulip sheaves to handle a single line with line-entry range of deflecting angles.

3355 3377
3356 3380
3357 3385
3379 3381



STANDARD



V sheaves are named for the unique V-shaped angled rollers that handle both axial and thrust loads.



T5, 28' foiling monohull © Harry KH / INEOS TEAM UK

C14843
3382



WIDE

C14823
3358
3378
3375
3376
3383
3384



WIDE TULIP



Part No.	Description	Sheave Ø		Width		Weight		Center pin Ø		Max line Ø		Maximum working load		Breaking load	
		in	mm	in	mm	oz	g	in	mm	in	mm	lb	kg	lb	kg
1.5T															
3355	1.5T sheave	1 7/8	47	3/4	19	2.4	68	0.619	15.71	11/32	9	3300	1500	6600	3000
3384	1.5T sheave/wide tulip	1 7/8	47	1 1/16	27	3.35	95	0.619	15.71	11/32	9	3300	1500	6600	3000
3T															
3356	3T sheave	2 3/16	56	3/4	19	2.89	82	0.893	22.67	7/16	11	6600	3000	13200	6000
3358	3T sheave/wide tulip	2 3/16	56	1 3/16	30	6.14	174	0.619	15.71	7/16	11	6600	3000	13200	6000
C14843	3T sheave/wide	2 3/16	56	1 3/16	30	5.36	152	0.619	15.71	7/16	8	6600	3000	13200	6000
5T															
3357	5T sheave	2 7/16	62	15/16	24	4.66	132	0.893	22.67	1/2	13	11000	5000	22000	10000
3378	5T sheave/wide tulip	2 7/16	62	1 3/8	35	8.04	228	0.893	22.67	1/2	13	11000	5000	22000	10000
3382	5T sheave/wide	2 7/16	62	1 1/4	32	6.42	182	0.893	22.67	1/2	13	11000	5000	22000	10000
6.5T															
3375	6.5T sheave/wide tulip	3 1/4	82	1 13/16	46	18.34	520	1.292	32.81	5/8	16	14300	6500	28600	13000
3379	6.5T sheave	3 1/4	82	1 5/32	29	10.02	284	1.292	32.81	5/8	16	14300	6500	28600	13000
8T															
3376	8T sheave/wide tulip	4 3/32	104	2 1/32	51	33.23	942	1.765	44.82	11/16	18	17600	8000	35200	16000
3377	8T sheave	4 3/32	104	1 9/32	32	18.52	525	1.765	44.82	11/16	18	17600	8000	35200	16000
12T															
3380	12T sheave	4 3/4	120	1 5/16	33	19.58	555	2.552	64.82	7/8	22	26400	12000	52800	24000
3383	12T sheave/wide tulip	4 3/4	120	2 9/16	65	47.62	1350	2.552	64.82	7/8	22	26400	12000	52800	24000
16T															
3385	16T sheave	5 5/16	135	1 17/32	39	27.3	774	2.946	74.82	1 1/16	26	35200	16000	70400	32000
C14823	16T sheave/wide tulip	5 5/16	135	2 27/32	72	64.55	1830	2.946	74.82	1 1/16	26	35200	16000	70400	32000
20T															
3381	20T sheave	6 1/8	155	1 19/32	40	37.32	1058	2.946	74.82	1 3/16	30	44000	20000	88000	40000

Delrin is a registered trademark of E. I. du Pont de Nemours and Company or its affiliates.

High-Load Sheaves

High-load sheaves are offered as replacement parts or for use in special applications. Their bearing system combines sideload-carrying balls with a PTFE composite bushing to carry radial loads. While not as free-rolling as the standard Harken ball/roller bearing system, this compact bearing system is extremely durable and perfect for carrying high loads in a restricted diameter.

Installation requires clamping or securing inner race.

Custom sheaves available by request. View more options on harken.com.

Use for:

- Masts
- Booms
- Deck organizers
- Through-the-transom running backstays



C7842



Part No.	Sheave Ø		Width		Weight		Center pin Ø		Line		Max Ø		Maximum working load		Breaking load*	
	in	mm	in	mm	oz	g	in	mm	in	mm	in	mm	lb	kg	lb	kg
712	4	102	7/8	22	10	284	11/16	17.6	1/2	12	5/16	8	12000	5443	32000	14515
714	5	127	1	25	17	481	7/8	22.28	5/8	16	5/16	8	15000	6804	51000	23133
716	6	152	1	25	23	652	7/8	22.28	5/8	16	3/8	10	18000	8165	51000	23133
727	2 1/4	57	7/8	22	4	113	3/8	10	1/2	12	5/16	8	4950	2245	9900	4491
754	3	76	7/8	22	5	142	1/2	12.7	1/2	12	5/16	8	7000	3175	16500	7484
1734	8	203	1 3/8	35	46	1300	1 1/4	31.7	7/8	22	1/2	12	37000	16783	100000	45360
C4579	6	152	1 1/4	32	32	903	1 31/64	37.74	7/8	22			41000	18600	82000	37200
C7842	3 1/2	90	1 15/16	50	20	578	11/16	18	5/8	16			12811	5811	25622	11622

*Based on use of solid 304 stainless shafts.

Narrow Halyard & Steering Sheaves

Narrow high-load sheaves in mastheads improve sail handling, speed sail changes, and allow the use of smaller, lighter halyard winches. Used in steering systems, these sheaves return “feel” to wheel-steered boats.

Sheaves combine sideload-carrying balls with a PTFE composite bushing for radial loads. These durable sheaves are made of 6061-T6 aluminum and are well-suited for masthead and steering installations.

Installation requires clamping or securing inner race.

Use for:

- Masthead/halyard sheaves
- Steering systems



Part No.	Sheave Ø		Width		Weight		Center pin Ø		Line		Max Ø		Maximum working load		Breaking load*	
	in	mm	in	mm	oz	g	in	mm	in	mm	in	mm	lb	kg	lb	kg
691	3	76	5/8	16	4.5	128	1/2	12.7	3/8	10	3/16	5	4000	1814	16500	7484
692	4	102	3/4	19	8	227	1/2	12.7	7/16	12	5/16	8	8250	3742	16500	7484
693	5	127	3/4	19	12	340	3/4	19.1	7/16	12	5/16	8	12000	5443	37100	16828
694	6	152	7/8	22	19	539	3/4	19.1	1/2	12	3/8	10	16000	7258	37100	16828

*Based on use of solid 304 stainless shafts.

Deck Organizers

Harken deck organizers lead halyards and control lines aft, allowing crew to sail from the security of the cockpit. The injection-molded composite top plate provides superior impact and UV resistance. Asymmetrical sheaves of glass-filled nylon have flared bases to lift lines up and off the deck, and combine with a proven bearing system to reduce friction. Organizers are available in two-, three-, four-, or five-sheave configurations and are stackable for multiple mounting options.



Jenga 99, J/99, 9.94 m (32.6'), J Composites, naval architect: Alan Johnstone © Gillian Pearson



Asymmetrical sheaves lift lines off deck.



Deck organizers stack for additional configurations.

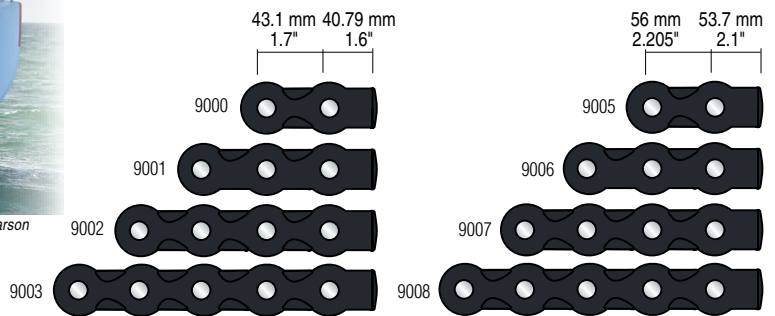

Part No.	Description	Sheave Ø		Length		Height		Weight		Max line Ø		Maximum working load/sheave†		Fasteners	
		in	mm	in	mm	in	mm	oz	g	in	mm	lb	kg	in	mm
40 mm															
9000	2-Sheave	1 9/16	40	4 1/16	104	15/16	24	2.47	70	1/2	12	1544	700	1/4 FH	6 FH
9001	3-Sheave	1 9/16	40	5 3/4	147	15/16	24	3.63	103	1/2	12	1544	700	1/4 FH	6 FH
9002	4-Sheave	1 9/16	40	7 15/32	190	15/16	24	4.76	135	1/2	12	1544	700	1/4 FH	6 FH
9003	5-Sheave	1 9/16	40	9 3/16	233	15/16	24	5.93	168	1/2	12	1544	700	1/4 FH	6 FH
50 mm															
9005	2-Sheave	1 15/16	50	5 5/16	135	1 7/32	31	4.80	136	5/8	16	2602	1180	5/16 FH	8 FH
9006	3-Sheave	1 15/16	50	7 1/2	191	1 7/32	31	7.02	199	5/8	16	2602	1180	5/16 FH	8 FH
9007	4-Sheave	1 15/16	50	9 11/16	247	1 7/32	31	9.24	262	5/8	16	2602	1180	5/16 FH	8 FH
9008	5-Sheave	1 15/16	50	11 15/16	303	1 7/32	31	11.46	325	5/8	16	2602	1180	5/16 FH	8 FH

DO NOT use Harken equipment for human suspension unless product is specifically certified and labeled for such.
 †If double stacked, upper block/organizer is two-thirds of listed MWL and breaking load.

Big Boat Deck Organizers

Use Big Boat deck organizers to lead multiple lines aft to halyard stoppers or winches. Organizers are also perfect for many other applications that call for a multiple-sheave, cheek-mounted lead block.

Deck organizers feature aluminum hardcoat-anodized sideplates for strength and corrosion resistance.

Use for:

- Halyards
- Reef lines
- Outhauls
- Pole lifts
- Control lines

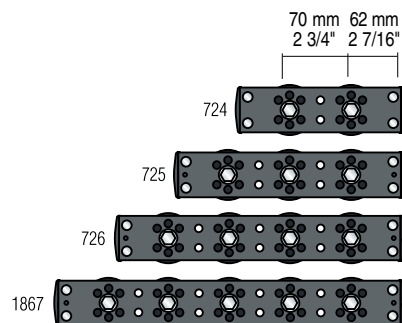

Saare 41ac, 12.42 m (41') © Saare Yachts



Big boat deck organizers are available with up to 10 sheaves by custom order.

Part No.	Description	Sheave Ø		Length		Height		Weight		Max Ø		Maximum working load/ sheave		Breaking load/ sheave		Maximum working load		Breaking load			
		in	mm	in	mm	in	mm	oz	g	in	mm	in	mm	lb	kg	lb	kg	lb	kg		
724	2-sheave*	2 1/4	57	7 9/16	192	1 1/8	29	19.5	553	1/2	12	5/16	8	4950	2245	9900	4491	4950	2245	9900	4491
725	3-sheave*	2 1/4	57	10 5/16	262	1 1/8	29	27.5	780	1/2	12	5/16	8	4950	2245	9900	4491	7425	3368	14850	6736
726	4-sheave*	2 1/4	57	13 1/16	332	1 1/8	29	35	992	1/2	12	5/16	8	4950	2245	9900	4491	9900	4491	19800	8981
1867	5-sheave*	2 1/4	57	15 13/16	402	1 1/8	29	44	1247	1/2	12	5/16	8	4950	2245	9900	4491	12375	5613	24750	11227

DO NOT use Harken equipment for human suspension unless product is specifically certified and labeled for such use. *Fasteners included—10 mm (3/8") x 75 mm (3") HH.

Spinnaker Pole Cars

Harken spinnaker pole cars feature recirculating ball bearings to permit adjustment under load. They roll freely on low-beam traveler track to allow crew to adjust for optimal sail shape. Machined aluminum hardcoat-anodized races permit Torlon® bearings to transition smoothly from active to return race for smooth trimming or easing.

Cars feature captive ball bearings, making them easy to load onto the track and to maintain.

Strong, lightweight cars are constructed from one-piece solid aluminum that is Hard Lube-anodized for strength and durability.

Ring fittings are 17-4 PH stainless steel and accept piston pole ends for end-to-end jibing. Midrange and Big Boat cars accept two popular toggle studs and Harken ball-end fittings. Cars are also available from Harken's Custom Division.

Use for:

Spinnaker poles
Whisker poles



Wire retaining clips keep balls captive, making cars easy to load and maintain. Composite corner keepers help keep ball bearings captive when the car is off the track. For a cost-effective option, CB+ cars can be modified to run on Harken non-CB track.

Cars fit low-beam track.

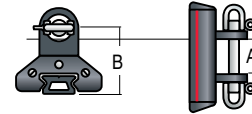

Manitou © Jeremy McMahon

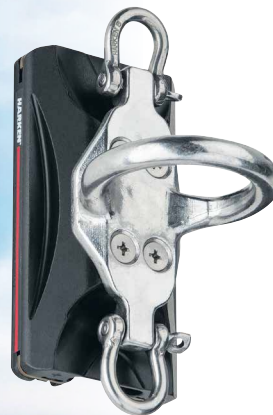

3188
3189



1645
1646
1647



3097
3098
3099

Torlon is a registered trademark of Solvay Advanced Polymers, L.L.C.
Forespar is a registered trademark of Forespar Products Corporation.

Part No.	Description	Max spin area		Length		Weight		Pin Ø		A		B		Maximum working load		Track	Pole end*
		ft²	m²	in	mm	oz	g	in	mm	in	mm	in	mm	lb	kg		
3188	Small Boat CB/ring	900	85	5	126	12	340							1125	510	2720	Piston
1645	Midrange CB/toggle	1500	140	5 3/16	132	22.4	635	1/2	12.7	1	25	2	51	2300	1043	R27	Forespar® toggle
1646	Midrange CB/bell	1500	140	5 3/16	132	23.2	658	15/32	12	1 1/2	38			2300	1043	R27	B120/B130 bell end
1647	Midrange CB/toggle	1500	140	5 3/16	132	24	680	5/8	16	1 3/16	30	2 1/8	54	2300	1043	R27	Sparcraft toggle
3189	Midrange CB/ring	1350	125	6	151	23.2	658							2100	953	R27	Piston
3097	Big Boat CB/bell	2000	186	7 1/4	184	46.4	1315	15/32	12	1 1/2	38			4050	1837	R32	B120/B130 bell end
3098	Big Boat CB/toggle	2000	186	7 1/4	184	47.2	1338	5/8	16	1 3/16	30	2 1/2	63	4050	1837	R32	Sparcraft toggle
3099	Big Boat CB/toggle	2000	186	7 1/4	184	45.6	1293	1/2	12.7	1	25	2 5/16	59	4050	1837	R32	Forespar® toggle

See page 275 for replacement balls. *Check dimensions of pole end toggle from suppliers listed.

Soft Attachments

Nodus Factory™ Loops

Nodus Factory soft attachments replace heavy stainless steel shackles on racing and cruising boats. Weight savings on large offshore boats can be as much as 91 kg (200 lb). Strong and lightweight, Nodus soft attachments are constructed using multiple coils of tough pre-stretched Dyneema® fiber and overlaid with Dyneema®— one of the most durable materials made. When fitting hardware, choose the Nodus loop that matches the attachment method shown in the chart. Contact Harken Tech support for questions about custom length loops.

T2 Loops

Use T2 Loops in Carbo T2 blocks. These strong, lightweight soft attachments are woven of Dyneema® fibers, and are load-set and locked-stitched to prevent stretch after installation.

Nodus Factory is a trademark of Nodus Factory Company.
Dyneema is a registered trademark of DSM Dyneema.



See page 19

Replacement T2 Loops

Part No.	Ø mm	Length		Weight		Use with
		in	mm	oz	g	
2154	3	5 1/2	140	.03	0.9	2148
2155	3	6 1/2	165	.04	1	2151
2179	3	14 1/2	370	.07	2	2148/2151



Part No.	Ø mm	Length		Weight		Vertical maximum working load		Choker maximum working load		Basket maximum working load		Fits blocks
		in	mm	oz	g	lb	kg	lb	kg	lb	kg	
3202	5	8	203	0.3	9	1275	578	1000	453	2550	1156	3214
3203	7	10	254	0.49	14	2550	1155	2040	920	5100	2310	3230
3139	9	4	100	0.7	20	3600	1630	2880	1305	7200	3265	
3140	9	8	200	1.4	40	3600	1630	2880	1305	7200	3265	
3141	9	11	280	2	55	3600	1630	2880	1305	7200	3265	
3142	10	5	125	1.1	30	5400	2445	4325	1960	10810	4900	
3143	10	9	230	2	55	5400	2445	4325	1960	10810	4900	
3144	10	15	380	3.3	94	5400	2445	4325	1960	10810	4900	3245
3145	11	5	125	1.7	50	7200	3265	5765	2610	14415	6535	
3146	11	9	230	3.1	88	7200	3265	5765	2610	14415	6535	
3147	11	16	400	5.4	154	7200	3265	5765	2610	14415	6535	3255
3148	12	6	150	2.3	65	9010	4085	7200	3265	18020	8170	
3149	12	11	280	4.2	120	9010	4085	7200	3265	18020	8170	
3150	12	17	430	6.5	180	9010	4085	7200	3265	18020	8170	

DO NOT use Harken equipment for human suspension unless product is specifically certified and labeled for such use.

Stainless Steel Shackles

Forged

Stainless steel shackles used on Harken blocks are available separately. Multiple configurations and sizes.

Stamped Shackles

The 072, 138, 246.PAIR, and 2761 shackles are used on most of the Small Boat blocks. They are also useful for a range of other applications.

Snap Shackles

The 111, 112, and 1584 snap shackles fit a variety of blocks and make them removable. Many use a snap shackle on the lower vang block so that it can be moved from the mastbase to the toerail for use as a preventer.

U-Adaptors

The 093 U-Adaptor allows blocks with 10 mm (3/8") posts to be attached to swivel bases or to other blocks with 10 mm (3/8") posts.

The 1598 U-Adaptor allows blocks with up to 15 mm (19/32") posts to be attached to swivel bases or to other blocks with 15 mm (19/32") posts.

The 463 U-Adaptor adapts 75 mm Carbo singles to swivel bases.

The 9050 U-adaptor allows 57/75 mm Carbo blocks to be attached to 170 Hexa-Cat Base or other blocks with 12.7 mm (1/2") posts and 6.35 mm (1/4") pins.

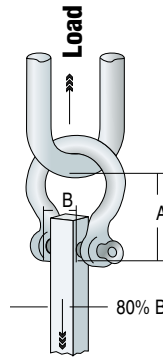

The breaking strengths shown are derived from tests that supported 80% of the length of the screw pin that is unsupported, which is similar to the area of a post in a block. Maximum working loads are no more than half the minimum breaking strength.

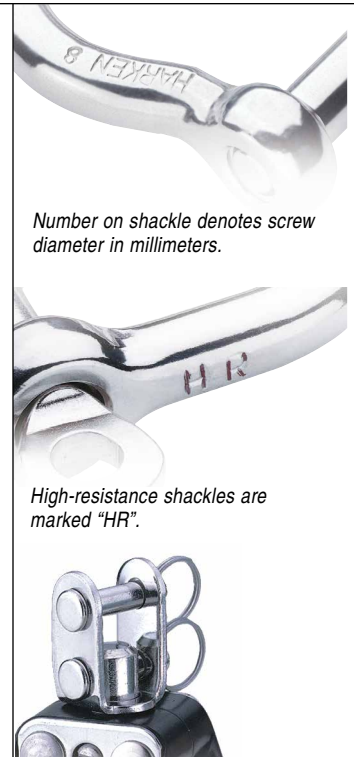

Number on shackle denotes screw diameter in millimeters.

High-resistance shackles are marked "HR".

U-Adaptors attach blocks to swivel bases or to other blocks.

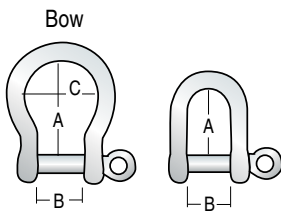

Captive Halyard

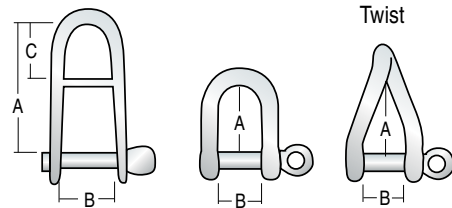

SNAP SHACKLES



2103, 2110
2117, 2124



2131, 2132



2108, 2115
2122, 2126



2109, 2116
2123, 2127



2107



2104, 2111
2118



2106



2105, 2112
2119, 2125

FORGED SHACKLES



072
138
246.PAIR
2761

STAMPED SHACKLES

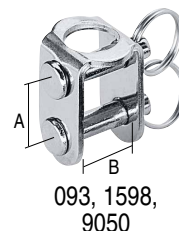

093, 1598,
9050

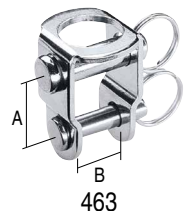

463

U-ADAPTORS

DO NOT use Harken equipment for human suspension unless product is specifically certified and labeled for such use.

Stainless Steel Shackles



© Hannah Lee Noll



Part No.	Description	Shackle pin Ø		Weight		A		B		C		Maximum working load		Breaking load	
		in	mm	oz	g	in	mm	in	mm	in	mm	lb	kg	lb	kg
Bow															
2103	5 mm	3/16	5	0.64	18	1	25	3/8	10	11/16	17	1190	540	2380	1080
2110	6 mm	1/4	6	1.04	29.5	1 1/16	27	9/16	14	3/4	19	1650	750	3300	1500
2117	8 mm	5/16	8	2.48	70.5	1 1/2	38	11/16	17	1 1/8	29	3040	1380	6080	2760
2124	10 mm	13/32	10	4.88	138.5	1 7/8	48	7/8	22	1 1/4	32	4870	2210	9740	4420
Shallow Bow															
2131	4 mm	5/32	4	0.3	8.5	5/8	16	5/16	8	7/16	11	810	367	1620	735
2132	5 mm	3/16	5	0.51	14.5	11/16	17	7/16	11	9/16	14	1190	540	2380	1080
Forged "D"															
2108	6 mm	1/4	6	0.88	25	3/4	19	9/16	14			1650	750	3300	1500
2115	8 mm	5/16	8	2.08	59	1	25	11/16	17			3040	1380	6080	2760
2122	10 mm	13/32	10	4.22	120	1 1/4	32	13/16	20			4870	2210	9740	4420
2126	12 mm	1/2	12	6.7	190	1 1/2	38	15/16	24			7120	3230	14240	6460
High-Resistance (HR) "D"															
2109	6 mm	1/4	6	0.8	22.5	3/4	19	9/16	14			2770	1260	5540	2510
2116	8 mm	5/16	8	2	56.5	1	25	5/8	16			5130	2330	10260	4650
2123	10 mm	13/32	10	3.92	111	1 1/4	32	13/16	20			8210	3720	16420	7450
2127	12 mm	1/2	12	6.8	193	1 3/4	44	1	25			12000	5440	24000	10880
Long															
2104	5 mm	3/16	5	0.78	22	1 1/2	38	3/8	10			1190	540	2380	1080
2111	6 mm	1/4	6	1.34	38	1 3/4	44	1/2	13			1650	750	3300	1500
2118	8 mm	5/16	8	3.01	85.5	2 1/4	57	5/8	16			3040	1380	6080	2760
Twist															
2105	5 mm	3/16	5	0.78	22	1 7/16	37	3/8	10			1190	540	2380	1080
2112	6 mm	1/4	6	1.12	32	1 1/8	29	1/2	12			1650	750	3300	1500
2119	8 mm	5/16	8	1.84	52	1 5/8	41	11/16	17			3040	1380	6080	2760
2125	10 mm	13/32	10	4.96	140.5	1 7/8	48	3/4	19			4870	2210	9740	4420
Large Open															
2106	5 mm	3/16	5	0.88	25	1 5/16	33	13/16	20			770	350	2200	1000
Captive Halyard															
2107	5 mm	3/16	5	1.12	32	1 3/8	35	9/16	14	9/16	14	1190	540	2380	1080
Stamped Shackles															
072	Small	3/16	5	0.29	8	1/2	12	7/16	11			1250	567	2500	1134
138	Large	1/4	6	0.54	15.5	11/16	17	5/8	16			1500	680	3000	1361
246.PAIR	Micro (pair)	5/32	4	0.18	5	7/16	11	3/8	9			600	270	1200	545
2761	Medium	1/4	6	0.45	12.7	5/8	15	9/16	14			1500	680	3000	1361
Snap Shackles															
111	Snap shackle	3/16	5	3	85	2 9/16	65					1000	454	2000	907
112	Large snap shackle	1/4	6	4.5	128	3 3/8	86					1500	680	3000	1361
1584	Midrange snap shackle	5/16	8	4	113	3 1/16	78					1800	816	3600	1633
U-Adaptors															
093	U-Adaptor	3/16	5	0.48	13.6	1/2	12	7/16	11			1250	567	2500	1134
463	U-Adaptor	3/16, 1/4	5, 6	0.58	16.3	9/16	14	13/32	10			1250	567	2500	1134
1598	Midrange U-Adaptor	5/16	8	1.57	44.4	1/2	12	7/8	22			1800	816	3600	1633
9050	U-Adaptor	1/4	6	0.92	26	11/16	17	5/8	15			1500	680	3000	1361

DO NOT use Harken equipment for human suspension unless product is specifically certified and labeled for such use.

Eyestraps

Eyestraps are useful accessories. They form light-duty mounting bases for blocks, serve as lash-down points, and can be used for fairleads.

Forged 316 stainless eyestraps are extremely strong and their smooth shape won't chafe line.

Harken offers two sizes of tough, nylon-resin eyestraps to secure shockcord, sheet bags, and other items where loads are light. Available in packages of six.

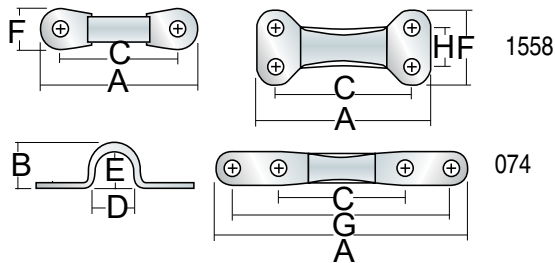
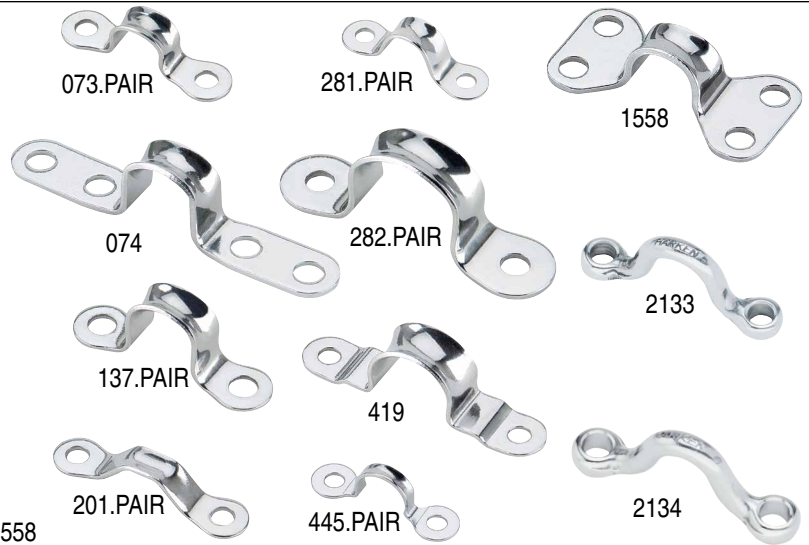

3287



3288



Sailart 17.5

Part No.	Weight		Fasteners (RH)		A	B	C	D	E	F	G	H	Fits	Breaking load						
	oz	g	in	mm										in	mm	in	mm	in	mm	in
073.PAIR*	.16	4.5	#10	5	1 11/16	43	1/2	12	1 1/4	32	7/16	11	3/8	10	7/16	11		1600	726	
074	.64	18	1/4"	6	3 1/4	83	3/4	19	1 1/2	38	5/8	16	5/8	16	9/16	14	2 3/4	70	4000	1814
137.PAIR*	.32	9	1/4"	6	2	51	3/4	19	1 1/2	38	5/8	16	5/8	16	9/16	14		150/365	3000	1361
201.PAIR*	.16	4.5	#10	5	1 7/8	48	3/8	10	1 1/2	38	9/16	14	1/4	6	7/16	11		150/365	1600	726
281.PAIR*	.16	4.5	#8	4	1 7/16	36	1/2	12	1 1/16	27	7/16	11	3/8	10	7/16	11		338/423	1000	454
282.PAIR*	.8	23	1/4"	6	2 13/16	71	15/16	23	2 1/16	52	7/8	22	3/4	19	3/4	19		280	3000	1361
419	.5	14	#10	5	2 1/2	64	3/4	19	2	51	3/4	19	5/8	16	1/2	12		418	1600	726
445.PAIR*	.09	2.5	#8	4	1 1/2	38	3/8	10	1 1/16	27	7/16	11	3/8	10	7/16	11			1000	454
1558	1	28	1/4"	6	2 1/4	57	5/8	16	1 3/4	45	5/8	16	7/16	11	1 1/8	29	5/8	16	6000	2722
2133	.35	10	#10	5	1 13/16	47	3/4	19	1 1/2	37	3/8	10	9/16	14	3/8	10			2500	1130
2134	.58	16.3	1/4"	6	2 1/4	56	13/16	21	1 3/4	43	11/16	17	5/8	15	1/2	12			3500	1588
3287	.28	7.8	1/4"	6	1 7/8	46	5/8	16	1 13/64	30	3/8	10	7/16	12	3/4	19			1200	544
3288	.14	4	#10	5	1 11/32	34	1/2	13	29/32	23	3/8	10	3/8	10	1/2	13			1200	544

DO NOT use Harken equipment for human suspension unless product is specifically certified and labeled for such use. *Sold in pairs.

Folding Padeyes

Folding padeyes keep deck and passageways clear. They're ready to attach a snatch block or fender, but fold safely out of the way when not needed.

Bolt-down bases and D-rings are 316 stainless steel. A vulcanized thermoplastic pad prevents rattling and holds the D-ring in position.

Use for:

- Loops/soft attachments
- Jacklines and tethers
- Leads
- Tie downs
- Lifting points
- Fenders



3206

3207

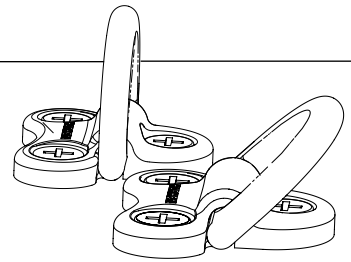
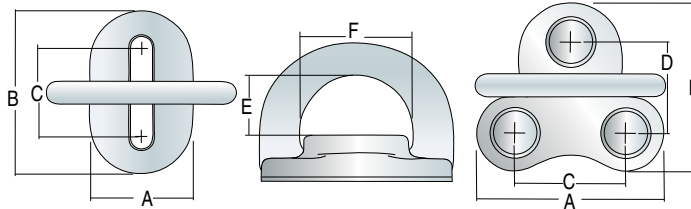

FOLDING PADEYES Q&A

HOW SHOULD I ALIGN THE LOAD ON A FOLDING PADEYE?

Folding padeyes differ from conventional padeyes in that the load should be perpendicular to the hinge and bail instead of in line with it. The strongest positions are with the D-ring vertical or leaning toward the fold-down position, which focuses the load on the side anchored with two screws.

Part No.	Description	A		B		C		D		E		F		Weight	Maximum working load		Breaking load		Fasteners (FH)		
		in	mm	in	mm	in	mm	in	mm	in	mm	in	mm		oz	g	lb	kg	lb	kg	in
3206	6 mm low-load	1	26	1 5/8	41.5	7/8	23	19/32	14.9	1 1/8	28	2.25	65	1760	800	3520	1600	1/4	6		
3207	6 mm	1 7/8	47	1 5/8	41.5	1 1/8	28	15/16	23	19/32	14.9	1 1/8	28	2.75	78	3080	1400	6160	2800	1/4	6

Padeyes

Padeyes are great for mounting blocks and are also used as attachment points for staysails, reefing blocks, and hundreds of other items.

Harken offers a range of stainless steel padeyes.

The diamond-shaped padeyes, 688 and 689, are 316 stainless and often used at mastbases where the diamond shape allows them to be mounted very close together. The 2759 is 316 cast stainless steel. The 627, 629, and 648 padeyes are 17-4 PH stainless.

For maximum strength always align fixed padeye bails to the load.



627
648
629



688



2759



689

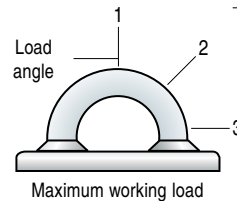
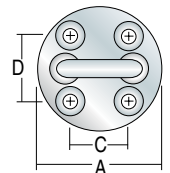
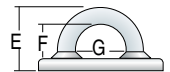
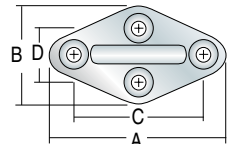

Part No.	Maximum working load						Breaking load						Fasteners (FH)	
	1		2		3		1		2		3		in	mm
	lb	kg	lb	kg	lb	kg	lb	kg	lb	kg	lb	kg		
627	5000	2270	4500	2040	4300	1950	10000	4535	9000	4080	8600	3900	1/4	6
629	20000	9070	12000	5440	14000	6350	40000	18140	24000	10890	28000	12700	1/2	12
648	11800	5358	10375	4705	8500	3855	23600	10716	20750	9430	17000	7710	3/8	10
688	3800	1770	5000	2270	4300	1950	7800	3540	10000	4535	8600	3900	1/4	6
689	8500	3855	8000	3628	7800	3540	19000	8618	17200	7800	15600	7075	5/16	8
2759	2550	1156	2392	1086	2450	1111	5100	2313	4784	2172	4900	2222	1/4	6

Part No.	Description	A		B		C		D		E		F		G		Weight	
		in	mm	in	mm	in	mm	in	mm	in	mm	in	mm	in	mm	oz	g
627	Small round	2 1/4	57			1 1/16	27	1 3/16	30	1 3/16	30	5/8	16	1 5/16	24	4.16	118
629	Large round	3 3/4	95			1 3/4	44	1 7/8	48	2	51	1 1/16	27	1 3/4	44	23	652
648	High-load medium	3	76			1 5/16	33	1 9/16	40	1 15/16	50	1 1/8	29	1 7/16	37	11	312
688	Small diamond	3 1/8	79	2	51	2 3/8	60	1 1/4	32	1 3/16	30	9/16	14	7/8	22	4.75	135
689	Large diamond	3 7/8	98	2 5/16	59	2 7/8	73	1 3/8	35	1 9/16	40	7/8	22	1 1/16	27	7.5	213
2759	Padeye/fits 22 mm cars with sheaves	2 1/4	56	3/4	18	1 1/2	38			1	26	9/16	15	5/8	16	1.3	38

DO NOT use Harken equipment for human suspension unless product is specifically certified and labeled for such use.

Harken Gizmos

Harken introduces Gizmos, a growing line of engineered soft-attach terminations and through-deck pieces. Gizmos acknowledge riggers' desires to minimize weight and eliminate as many heavy metal fasteners as possible.

Harken's reputation for precision manufacturing assures the Gizmos are precision-sized and fit together perfectly when assembled. Perhaps most importantly, our distribution network guarantees Gizmos are available in the quantities you need—when you need them.

Through-Deck Bushings

Single-sided through-deck bushings are designed to protect decks and lines from chafing using any through-deck application. Double-sided through-deck bushings are perfect for installing soft-attach loops to protect line from wear and also to separate line.

Padeye Kits

Padeye kits include a cross pin, waterproof cap and O-ring and convert a double-sided bushing into a through-deck, watertight padeye. The cross pin attaches the rope/loop and the cap snaps over the top to keep water out.

Stay tuned, Harken will soon be offering more Gizmo rigging solutions!

GIZMOS



SINGLE THROUGH-DECK BUSHINGS



DOUBLE THROUGH-DECK BUSHINGS



PADEYE KITS

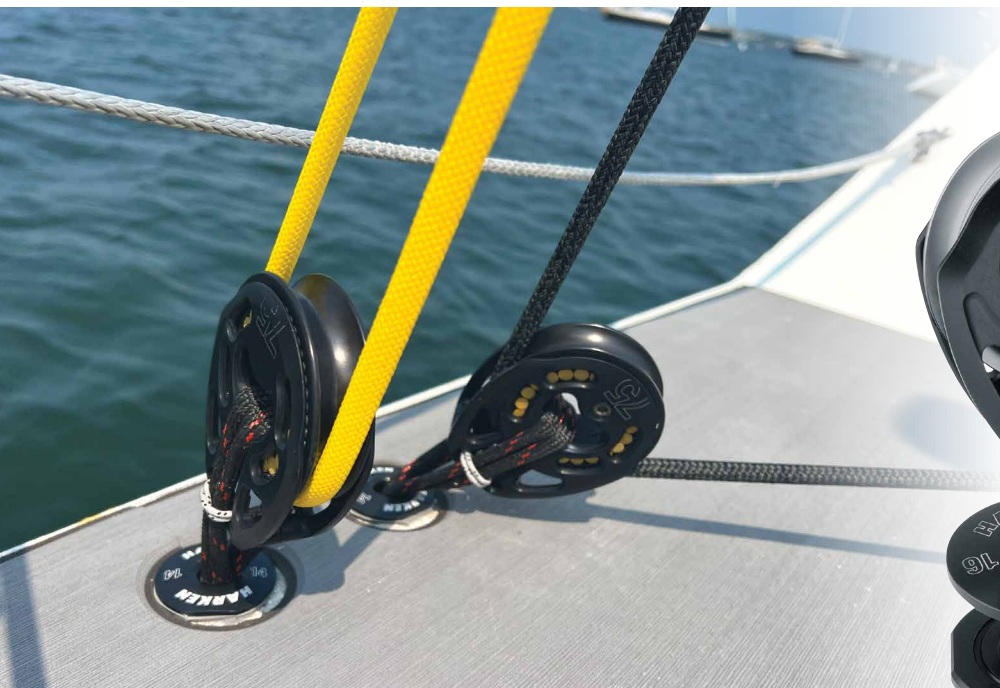

Harken Gizmos



Through-Deck Bushings

Part No.	Description	Center hole Ø		Outside Ø		Shaft Ø		Drill size		Deck thickness				Weight		Maximum working load	
		in	mm	in	mm	in	mm	in	mm	Min	mm	in	mm	oz	g	lb	kg
9060	6 mm/single	0.236	6	0.728	18.5	0.354	9	13/32	10			.787	20	0.1	2.8		
9061	8 mm/single	0.313	8	0.984	25	0.472	12	1/2	13			1.181	30	0.25	7.2		
9062	10 mm/single	0.394	10	1.102	28	0.591	15	5/8	16			1.181	30	0.38	10.8		
9063	12 mm/single	0.472	12	1.228	31.2	0.669	17	23/32	18			1.181	30	0.47	13.2		
9064	14 mm/single	0.551	14	1.606	40.8	0.827	21	7/8	22			1.181	30	0.8	22.7		
9070.0608	6 mm/double/6-8 mm deck	0.236	6	0.98	24.9	0.512	13	9/16	14	0.236	6	0.315	8	0.23	6.5		
9070.0810	6 mm/double/8-10 mm deck	0.236	6	0.98	24.9	0.512	13	9/16	14	0.315	8	0.394	10	0.25	7.1		
9070.1013	6 mm/double/10-13 mm deck	0.236	6	0.98	24.9	0.512	13	9/16	14	0.394	10	0.512	13	0.27	7.6		
9071.0810	8 mm/double/8-10 mm deck	0.313	8	1.106	28.1	0.591	15	5/8	16	0.315	8	0.394	10	0.34	9.7		
9071.1013	8 mm/double/10-13 mm deck	0.313	8	1.106	28.1	0.591	15	5/8	16	0.394	10	0.512	13	0.37	10.4		
9071.1318	8 mm/double/13-18 mm deck	0.313	8	1.106	28.1	0.591	15	5/8	16	0.512	13	0.709	18	0.41	11.5		
9071.1828	8 mm/double/18-28 mm deck	0.313	8	1.106	28.1	0.591	15	5/8	16	0.709	18	1.102	28	0.47	13.4		
9072.1013	10 mm/double/10-13 mm deck	0.394	10	1.228	31.2	0.669	17	23/32	18	0.394	10	0.512	13	0.49	13.9	1540	700
9072.1318	10 mm/double/13-18 mm deck	0.394	10	1.228	31.2	0.669	17	23/32	18	0.512	13	0.709	18	0.54	15.2	1540	700
9072.1828	10 mm/double/18-28 mm deck	0.394	10	1.228	31.2	0.669	17	23/32	18	0.709	18	1.102	28	0.61	17.4	1540	700
9072.2848	10 mm/double/28-48 mm deck	0.394	10	1.228	31.2	0.669	17	23/32	18	1.102	28	1.890	48	0.77	21.8	1540	700
9073.1013	12 mm/double/10-13 mm deck	0.472	12	1.606	40.8	0.827	21	7/8	22	0.394	10	0.512	13	0.91	25.7	3300	1500
9073.1318	12 mm/double/13-18 mm deck	0.472	12	1.606	40.8	0.827	21	7/8	22	0.512	13	0.709	18	0.98	27.7	3300	1500
9073.1828	12 mm/double/18-28 mm deck	0.472	12	1.606	40.8	0.827	21	7/8	22	0.709	18	1.102	28	1.1	31.1	3300	1500
9073.2848	12 mm/double/28-48 mm deck	0.472	12	1.606	40.8	0.827	21	7/8	22	1.102	28	1.890	48	1.34	38	3300	1500
9074.1013	14 mm/double/10-13 mm deck	0.551	14	1.874	47.6	0.945	24	31/32	25	0.394	10	0.512	13	1.38	39	5060	2300
9074.1318	14 mm/double/13-18 mm deck	0.551	14	1.874	47.6	0.945	24	31/32	25	0.512	13	0.709	18	1.46	41.5	5060	2300
9074.1828	14 mm/double/18-28 mm deck	0.551	14	1.874	47.6	0.945	24	31/32	25	0.709	18	1.102	28	1.61	45.7	5060	2300
9074.2848	14 mm/double/28-48 mm deck	0.551	14	1.874	47.6	0.945	24	31/32	25	1.102	28	1.890	48	1.91	54.2	5060	2300
9075.1013	16 mm/double/10-13 mm deck	0.625	16	1.98	50.3	1.024	26	1 1/32	27	0.394	10	0.512	13	1.61	45.6	7480	3400
9075.1318	16 mm/double/13-18 mm deck	0.625	16	1.98	50.3	1.024	26	1 1/32	27	0.512	13	0.709	18	1.71	48.4	7480	3400
9075.1828	16 mm/double/18-28 mm deck	0.625	16	1.98	50.3	1.024	26	1 1/32	27	0.709	18	1.102	28	1.88	53.2	7480	3400
9075.2848	16 mm/double/28-48 mm deck	0.625	16	1.98	50.3	1.024	26	1 1/32	27	1.102	28	1.890	48	2.22	62.8	7480	3400

Padeye Kits

Part No.	Description	Weight			Maximum working load		Use with
		oz	g	lb	kg		
9072.PADEYE	10 mm padeye kit	0.19	5.3	1540	700	2173	
9073.PADEYE	12 mm padeye kit	0.41	11.6	3300	1500	3214, 3294AL, 3366AL	
9074.PADEYE	14 mm padeye kit	0.63	17.9	5060	2300	3230, 3299	
9075.PADEYE	16 mm padeye kit	0.84	23.9	7480	3400	3245, 3295AL, 3367AL	

Removable & Fixed Padeyes

Removable Padeyes

Harken offers a variety of removable padeyes for blocks from 57 mm Black Magic, to custom blocks with maximum working loads of 23,000 kg (50,715 lb). Bases swivel so padeyes align to the load. This prevents the reduction of the block's maximum working load. The swivel feature is a Harken exclusive.

Fixed Padeyes

In-deck padeyes are recessed into the deck creating a discreet, low-profile design. Lightweight and compact, Harken padeyes work well with almost any soft-attach block, including Black Magic Loop blocks, Snatch blocks and V blocks.

Padeyes are mirror-polished, stainless steel to complement the look of classic and modern yachts.



HC7852



C6779
C9374
C9761



C10768
C9512
C9511
C9760

C9775
C9240



C9064
C8997

In-deck loop padeyes provide a clutter-free deck.

See page 89

627
648
629



HC7343
HC6107
HC8224

REMOVABLE PADEYES

Removable Tops

Part No.	Description	Above deck Ø		Weight		Maximum working load		Use with
		in	mm	oz	g	lb	kg	
HC8207	Bail top	2 1/4	57	7.4	209	4410	2000	HC7340
HC7327	Swivel top	2 1/4	57	9.6	272	5005	2270	HC7340, 627
HC7388	Swivel top	3 1/4	83	22.4	635	11814	5358	C10768, HC7389, 648
HC7224	Swivel top	4 1/4	108	28.5	807	20000	9070	HC7403, C9512, 629
C6779	Stand-up toggle top*	4 1/4	108	54.8	1553	20000	9070	HC7403, C9512
C9374	Stand-up toggle top*	3 15/16	100	86	2439	33075	15000	C9511, C9775
C9761	Stand-up toggle top*	6 1/2	165	176.3	4999	50715	23000	C9760, C9240

Assemblies (Top & Bottom)

Part No.	Component	
	Deck cup	Top
HC7852	HC7340	HC8207
HC7343	HC7340	HC7327
HC6107	HC7389	HC7388
HC8224	HC7403	HC7224
C9527*	C9511*	C9374*
C9758*	C9760*	C9761*

Removable Padeye Deck Cups

Part No.	Description	Above deck Ø		Weight		Fasteners	Maximum working load		Use with
		in	mm	oz	g		lb	kg	
HC7340	Bolt-down deck cup	2 1/4	57	4.5	127	4 x M6	5005	2270	HC8207, HC7327
C10768	Stud deck cup*	3 1/4	83	45	1275	1 x M39	11025	5000	HC7388
HC7389	Bolt-down deck cup	3 1/4	83	12.8	362	4 x M10	11814	5358	HC7388
HC7403	Bolt-down deck cup	4 1/4	108	41.6	1179	4 x M12	20000	9070	HC7224, C6779, C9584
C9512	Stud deck cup*	3 3/4	95	53.8	1524	1 x M48	26460	12000	HC7224, C6779
C11177	Soft attachment*	3 1/2	90	127.4	3610	1 x M60	22046	10000	C11173, C11334
C9511	Stud deck cup*	3 15/16	100	71.1	2016	1 x M56	33075	15000	C9374, C11003
C9775	Bolt-down deck cup*	5 1/2	139	63.2	1792	6 x M16	33075	15000	C9374, C11003
C9760	Stud deck cup*	4 1/2	114	148	4196	1 x M76	50715	23000	C9761
C9240	Bolt-down deck cup*	6 1/2	165	88.8	2517	6 x M20	50715	23000	C9761

FIXED PADEYES



C9064
C8997



C9153
C9057
C10063

Fixed Padeyes

Part No.	Description	Above deck Ø		Weight		Maximum working load	
		in	mm	oz	g	lb	kg
C9064	5T soft attachment*	3 11/32	85	41.6	1179	11025	5000
C8997	12T soft attachment*	4 3/16	106	88.2	2500	26460	12000
C9153	5T U-Bolt*			17.8	505	11025	5000
C9057	9T U-Bolt*			37.4	1021	19845	9000
C10063	12T U-Bolt*			106	2215	26460	12000

DO NOT use Harken equipment for human suspension unless product is specifically certified and labeled for such use. *Contact Harken to request quote and lead time.

Lead Rings

Harken lead rings are simple, weight-saving devices used to route line for jib in-haulers, twings, barberhaulers, Lazy Jacks, cascading backstays and other applications requiring minimal fine-tune adjustments. Rings are Hard Lube-anodized 6061-T6 aluminum for a smooth, slippery surface. With no moving parts, wear is minimal.

LEAD RINGS Q&A

I'M THINKING OF USING HARKEN LEAD RINGS TO ADJUST MY VANG. WHAT ARE YOUR THOUGHTS?

Harken Lead Rings should only be used for applications with high static loads, where trimming angles aren't acute, or where only minor adjustments are needed. They will definitely save you weight in your vang system, but you'll be adding friction to the line compared to free-running ball bearing blocks.



Part No.	Description	Center hole Ø		Outer groove width		Weight	
		in	mm	in	mm	oz	g
3269	Lead ring	5/16	8	3/16	5	0.093	2.65
3270	Lead ring	7/16	10	1/4	6	0.155	4.4
3271	Lead ring	9/16	14	7/16	10	0.414	11.75
3272	Lead ring	7/8	20	9/16	14	1.34	37.85
3273	Lead ring	1 1/8	28	7/8	20	3.7	105
3282	Floating jib lead ring	23/32	18	5/16	8	1.36	38.5
3283.PAIR	Lead ring (pair)	3/16	5	1/8	3	0.029*	0.82*
3284.PAIR	Lead ring (pair)	1/4	6	5/32	4	0.053*	1.5*
C15267	4.5T floating	1	25	1 1/3	33	7.4	210
C12814	8T floating	1 7/16	37	1 27/32	47	10.23	290
C12343	12T floating	2 1/4	57	3 1/8	80	31.4	890
C15229	16T floating	3	78	4 1/8	105	98.77	2800

*Weight each.



Sugar 3, Italia 11.98, 11.98 m (39'), Italia Yachts, naval architect: Matteo Polli © Fabio Taccola



3282



3283



3284



3269



3270



3271



3272



3273

LEAD RINGS



C15267



C12814



C12343



C15229

FLOATING BLOCKS

Jib Leads & Fairleads

Bolt-Down Fairleads

Harken Bolt-Down Fairleads are used as shallow-angle line deflectors on boats 6 - 21 m (20 - 70'). These weight-saving fairleads are built of 6061-T6 Hard Lube-anodized aluminum for durability. Smooth surfaces and radiused center holes minimize line wear.

Bolt-Down Fairleads are available in multiple configurations with 12-, 14-, and 16-mm hole sizes.

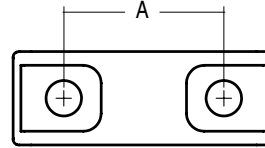

Fastener spacing



TECH TIP

Hex-head bolts are ideal for one-person through-deck fastening as the hexagonal head is held securely by the sides of the inset when being tightened.

Grand Prix Jib Leads

Strong aluminum jib leads deflect jib sheets to winches, preventing overrides. These jib leads have two small drilled holes through which a loop can be spliced to attach the hobble. This temporarily secures the jib/genoa clew to free-up a winch for mark roundings.



© Yann Riou - polaRYSE

Part No.	Description	Length		Width		Height		Max line Ø		Weight		Fasteners*		A	Maximum working load		Breaking load	
		in	mm	in	mm	in	mm	in	mm	oz	g	in	mm		mm	lb	kg	lb
Bolt-Down Fairlead																		
3274	1 - 12 mm hole	1 7/8	48	11/16	18	1 1/8	28.2	3/8	10	.99	28	1/4	6	32	2000	908	4000	1816
3275	2 - 12 mm holes	2 7/8	74	11/16	18	1 1/8	28.2	3/8	10	1.73	49	1/4	6	57.4	2000	908	4000	1816
3276	3 - 12 mm holes	3 7/8	99	11/16	18	1 1/8	28.2	3/8	10	2.43	69	1/4	6	82.8	2000	908	4000	1816
9300	1 - 14 mm hole	1 6/7	47	6/7	21.6	1 1/7	29.3	1/2	12	0.843	23.9	1/4	6	30	2204	1000	4409	2000
9301	2 - 14 mm holes	3	76	6/7	21.6	1 1/7	29.3	1/2	12	1.6	45.4	1/4	6	58.7	2204	1000	4409	2000
9302	3 - 14 mm holes	3 7/16	87	6/7	21.6	1 1/7	29.3	1/2	12	2.02	57.5	5/16	8	28.7	3968	1800	7936	3600
9303	4 - 14 mm holes	4 9/16	116	6/7	21.6	1 1/7	29.3	1/2	12	2.8	79.2	5/16	8	57.5	3968	1800	7936	3600
9304	5 - 14 mm holes	5 5/7	145	6/7	21.6	1 1/7	29.3	1/2	12	3.56	100.9	5/16	8	86.2	3968	1800	7936	3600
9305	6 - 14 mm holes	6 5/6	174	6/7	21.6	1 1/7	29.3	1/2	12	4.2	119.3	5/16	8	57.5	5952	2700	11905	5400
3277	1 - 16 mm hole	2 3/8	60	7/8	22	1 1/4	31.8	9/16	14	1.66	47	5/16	8	37	4000	1816	8000	3632
3278	2 - 16 mm holes	3 9/16	91	7/8	22	1 1/4	31.8	9/16	14	2.82	80	5/16	8	67.5	4000	1816	8000	3632
3279	3 - 16 mm holes	4 3/4	121	7/8	22	1 1/4	31.8	9/16	14	3.95	112	5/16	8	98	4000	1816	8000	3632
Jib lead																		
3280	Midrange	2 15/16	75	7/8	22	1 7/16	37	1/2	12	2.97	84	1/4	6	55	1500	680	3000	1360
3281	Big Boat	4 15/16	125	1 1/8	29	2 5/16	58	7/8	22	9.72	276	7/16**	10***	96	4250	1930	8500	3860

92 **HH, SH, CH in 6 mm, 5/16" and 8 mm. Size 1/4" in SH only. ***7/16" in HH and SH. ****10 mm in HH, SH and CH. DO NOT use Harken equipment for human suspension unless product is specifically certified and labeled for such use.

Aluminum Tiller Extension

The rigid anodized body of this tiller extension transmits subtle boat and rudder movements, allowing the skipper to steer by the feel of the helm. The simple and lightweight design has no unnecessary frills—every aspect contributes to its strength, stiffness, or comfort. The universal joint and nonslip foam grip are UV-protected and perfect for full dagger-grip and fingertip steering.



Base cover snaps off to remove tiller extension.

Universal joint rotates 360°.

Nonslip foam rubber grip.

- 7100.24
- 7100.30
- 7100.33
- 7100.36
- 7100.42
- 7100.48

Part No.	Description	Length		Tube Ø		Weight		Fastener spacing		Fasteners		Joint type	Tube material
		in	mm	in	mm	oz	g	in	mm	in	mm		
7100.24	Tiller extension	23 5/8	600	5/8	16	4.1	117	1 1/4	31.8	3/16	5	Universal	Aluminum
7100.30	Tiller extension	29 1/2	750	5/8	16	4.9	138	1 1/4	31.8	3/16	5	Universal	Aluminum
7100.33	Tiller extension	31 1/2	800	5/8	16	5.2	149	1 1/4	31.8	3/16	5	Universal	Aluminum
7100.36	Tiller extension	35 7/16	900	5/8	16	5.6	160	1 1/4	31.8	3/16	5	Universal	Aluminum
7100.42	Tiller extension	41 3/8	1050	5/8	16	6.3	178	1 1/4	31.8	3/16	5	Universal	Aluminum
7100.48	Tiller extension	47 1/4	1200	5/8	16	7.1	203	1 1/4	31.8	3/16	5	Universal	Aluminum
7101	Tiller extension base*	1 3/4	44			0.18	5	1 1/4	31.8	3/16	5		
7102	Replacement universal joint			5/8	16	0.46	13					Universal	

*Fasteners not included

Halyard Tensioners

Designed for rope or wire halyards on large cruisers, the Harken halyard tensioner locks halyards at full hoist and frees your halyard winch for other functions.

The one-piece aluminum car body is Hard Lube-anodized for durability. Track is extruded from 6061-T6 aluminum and hardcoat-anodized for a hard, long-lasting surface.

Choose the 40 mm version in single-pin, double-pin, or triple-pin configurations based on required working load. 32 mm version available in single-pin only. Custom cars can be designed to handle higher loads.



To lock pin in up position, pull the handle up with a lanyard or by hand and twist 90 degrees.

Part No.	Description	Length		Width		Weight		Maximum working load	
		in	mm	in	mm	oz	g	lb	kg
32 mm T-Track									
HC9639	Single-pin car	6	152	2 1/4	57	18.67	529	6615	3000
HC9733	Self-locking 32 mm track	29 1/2	750	1 1/4	32				
40 mm T-Track									
HC9504	Single-pin car	6 5/16	160	2 9/16	65.1	20.34	577	8818	4000
HC9503	Self-locking 40 mm track for single/double pin	29 1/2	750	1 9/16	40	31.39	890		
HC9953	Self-locking 40 mm track for single/double pin	59 1/16	1500	1 9/16	40	60.56	1717		



TRAVELERS

& GENOA LEADS

NEW FOR 2024

**22 mm Loop –
R28in Horizontal
Bend**

SEE PAGE 103



Dinghy Pinstop Jib Lead Cars

These easy-to-adjust cars combine a spring-loaded pinstop with precise track spacing. Use on dinghies and small sport boats with jibs up to 13 m² (140 ft²). Cars are built of tough 6061-T6 aluminum that is Hard Lube-anodized for durability. Track is hardcoat-anodized.

The 450 pinstop jib lead has a removable bail to attach a spring and block. The 452 bullseye lead has a controlled pivot angle so the cleat is always within easy reach.



Flexible, lightweight, lashing attachment allows block to articulate freely on 450 jib car.

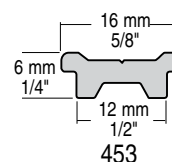

Cars

Part No.	Description	Length		Width		Height		Weight		Maximum working load		Breaking load		Track
		in	mm	in	mm	in	mm	oz	g	lb	kg	lb	kg	
450	Bail/pinstop	2 5/8	67	15/16	23	1 1/16	27	2	55	350	159	700	318	453
452P	Bullseye/swivel/365 Carbo-Cam (port)	3 1/8	79	3 7/16	87	2 7/16	62	7	194	250	113	500	227	453
452S	Bullseye/swivel/365 Carbo-Cam (stbd)	3 1/8	79	3 7/16	87	2 7/16	62	7	194	250	113	500	227	453

Track

Part No.	Description	Length		Mounting hole spacing		Weight		Fasteners (FH)	
		in	m	in	mm	oz	g	in	mm
453.9.5	Low-beam/pinstop holes*	9 1/2	0.24	3	76	1.22	35	#10	5
453.12	Low-beam/pinstop holes*	11 11/16	0.3	3	76	1.5	43	#10	5
453.15	Low-beam/pinstop holes*	14 11/16	0.37	3	76	1.8	52	#10	5
453.18	Low-beam/pinstop holes*	17 11/16	0.45	3	76	2.3	65	#10	5
453.24	Low-beam/pinstop holes*	23 11/16	0.6	3	76	3.1	87	#10	5

*1st hole 34 mm (1 3/8").



Ordering Traveler Systems

1. Determine System Size

Determine size of traveler system (13, 22, 27, 32, 42, or 64 mm) based on mainsail area, placement on the boom, and mono- or multihull. See Mainsail Traveler System Size Selection chart. Typical boat lengths are listed as a guideline only.

Typical Boat Lengths:

22 mm Small Boat: 6.7 - 8.5 m (20' - 28')
 27 mm Midrange: 7.9 - 10.7 m (26' - 35')
 32 mm Big Boat: 10.4 - 12.8 m (34' - 46')

Mainsail Traveler System Size Selection

Cars	Maximum mainsail area							
	Monohulls				Multihulls			
	End-boom sheeting		Mid-boom sheeting		End-boom sheeting		Mid-boom sheeting	
	ft ²	m ²	ft ²	m ²	ft ²	m ²	ft ²	m ²
Dinghies/Light Daysailers								
13 mm Micro CB	110	10.2	85	8	85	8	70	6.5
22 mm Small Boat CB: low-load	125	11.6	100	9.3	100	9.3	80	7.5
22 mm Small Boat CB: standard	160	14.9	135	12.5	135	12.5	110	10.2
22 mm Small Boat CB: high-load:1250 series	200	18.6	160	14.9	160	14.9	135	12.5
27 mm Midrange CB: standard	350	32.5	285	26.5	275	25.5	215	20
Small Offshore Boats/Heavy Daysailers								
22 mm Small Boat CB: standard	150	14	125	11.5	135	12.5	110	10.2
22 mm Small Boat CB: high-load:1250 series	190	17.5	150	14	160	14.9	125	11.5
27 mm Midrange CB: standard	260	24	215	20	215	20	160	14.9
27 mm Midrange CB: high-load	300	28	240	22	240	22	190	17.5
Large Offshore Boats								
32 mm Big Boat CB: standard	425	39.5	350	32.5	350	32.5	300	28
32 mm Big Boat CB: high-load	550	51	450	42	450	42	350	32.5
32 mm Big Boat CB: 2 stand-up toggles/32 mm CRX Roller: 3074	575	53.4	500	46.5	500	46.5	425	39.5
32 mm Big Boat CB: 2 T3201Bs joined by 580	700	65	525	49	525	49	450	42
32 mm Big Boat CB: 2 high-load cars coupled	1100	102	900	83.6	900	83.6	750	69.7
42 mm Mini-Maxi: 3068/32 mm CRX Roller: 3075	1100	102	900	83.6	900	83.6	750	69.7
64 mm Maxi	1400	130	1100	102	1100	102	900	83.6

2. Select Track

Select size and length of track (sizes listed by width measurement of top of track in millimeters). Choose low-beam track if it will be supported the entire length. Choose high-beam track for spanning companionways, cockpits, etc.

13 MM MICRO

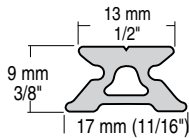

2707

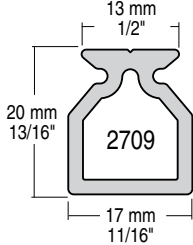

2709

22 MM SMALL BOAT

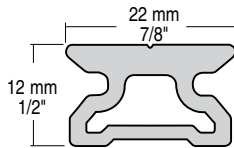

373

2720/2751

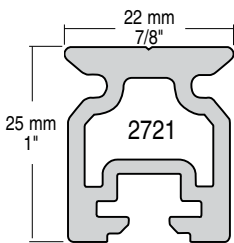

2721

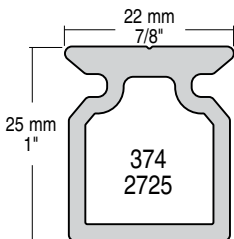

374

2725

27 MM MIDRANGE

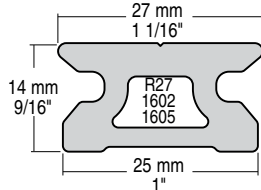

14 mm
9/16"

R27
1602
1605

25 mm
1"

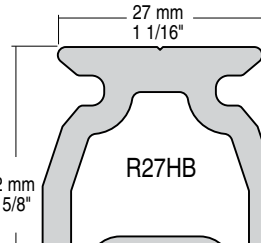

R27HB

42 mm
1 5/8"

31 mm
1 7/32"

32 MM BIG BOAT

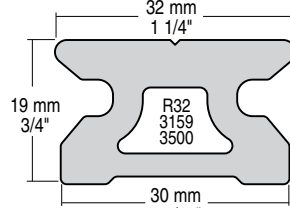

19 mm
3/4"

R32
3159
3500

30 mm
1 3/16"

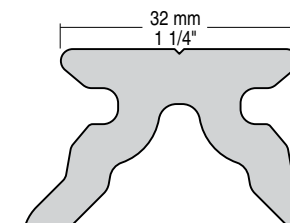

R32HB

57 mm
2 1/4"

42 mm
1 5/8"

LOW-BEAM

HIGH-BEAM



Ordering Traveler Systems

3. Select Car & Purchase Requirements

Based on system size and purchase requirements, select a car and accessories that match track and load requirements. Select control blocks for the car.

A kit contains car-mounted components to make a 2:1, 3:1, or 4:1 system. 27 and 32 mm systems only.

Cars come standard with shackles for attaching the mainsheet to the car. Upgrade to a stand-up toggle with control tangs to attach high-performance ball bearing control blocks. See Purchase Selection Guides for examples and sizing.



4. Choose End Controls

Choose end controls that mate with the control blocks on the traveler car for the correct purchase system, including a deadend, allowing clean-running lines. Use Carbo ball bearing end controls with toggle-mounted, ball bearing control blocks, or use ESP sleeve bearing end controls with ESP car-mounted, sleeve-bearing control blocks.

Options include end controls with attached cams, or purchase cams separately and mount remotely. See pages 260 - 261 for common systems.

5. Choose Endstops

Endstops are designed to absorb shock loads and should be installed when end controls are not used. Trim caps finish off track ends cleanly. Select high- or low-beam endstops/trim caps to match track. Low-beam, line-shedding endstops prevent snags. Sold in pairs.

6. More Information

Previous steps show the most common configurations. Other options include windward sheeting cars, soft attachments, coupled cars, track risers, and track splice links.

If you have questions, contact a professional rigger or Harken Technical Service at technicalservice@harken.com.



CARBO BALL BEARING END CONTROLS

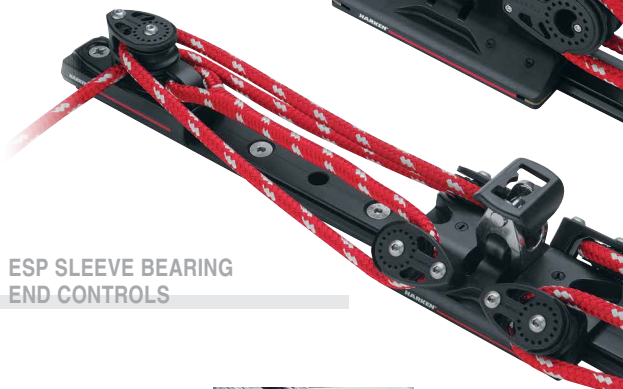

ESP SLEEVE BEARING END CONTROLS



WINDWARD SHEETING



SOFT-ATTACH



COUPLED CARS



TRACK RISERS

Ordering Genoa Lead Systems

The chart below sizes lead cars for the #1, #2, and #3 genoas based on typical loads for these sails. See Block Loading vs Angle of Deflection and Genoa System Loading on page 279 to size for different deflection angles and wind speeds. Visit www.harken.com or see page 259 for common configurations.

Adjustable genoa lead cars	Maximum sail area										Assumes 155% genoa/25 knots apparent wind/45° sheet lead angle				
	22 mm Small Boat					32 mm Big Boat						Mini-Maxi			
	27 mm Midrange		Standard		High-load		Standard		High-load						
ft ²	m ²	ft ²	m ²	ft ²	m ²	ft ²	m ²	ft ²	m ²	ft ²	m ²	ft ²	m ²	Assumes 100% genoa/40 knots apparent wind/60° sheet lead angle	
#1 & #2 genoa	450	41	750	70	1500	139	2700	251	4400	409					
#3 genoa	175	16	330	31	435	40	650	60	1300	121					



CB TRAVELERS & GENOA LEAD CARS



Harken ball bearing traveler and genoa lead cars with multipart purchases allow easy adjustment of loaded sails from the cockpit. Whether racing or cruising, these smooth-rolling systems pay huge dividends in sail control and are safer and faster than playing the sheet. CB (captive bearing) systems are available in four sizes to fit boats from the smallest dinghies to big boats. Non-CB systems (CRX, Mini-Maxi, and Maxi) are offered for larger yachts.

Strong, corrosion-resistant cars and track stand up to sun, salt, and time

- One-piece, 6061-T6 aluminum cars
Hard Lube-anodized, UV-stabilized.
- Cars CNC sculpted to remove excess weight.
- Track is 6061-T6 aluminum, hardcoat-anodized.

Low-friction ball bearing cars for easy adjustment under load

- Torlon® bearings roll smoothly under both high and low loads.



Easy loading and maintenance

- CB wire retaining clips and composite corner keepers keep ball bearings captive when car is off the track.



Choice of end-boom or mid-boom configurations

- Use with high-beam track when raising traveler out of cockpit.



Cost-effective retrofit options

- CB+ cars can be modified to run on old style Harken non-CB track supplied until 2003; upgrade cars without replacing track. Look for the plus sign on the end of the car to confirm that it is a CB+ car.

Replacement kits restore traveler performance

- Harken replacement traveler kits are the fastest, easiest way to replace an old traveler with one that fits and works correctly. Take the guesswork out of picking the right parts.
- Five boxed kits come in three sizes: two Small Boat, two Midrange, and one Big Boat.
- Kits meet installation requirements of boats from 5.5 – 13.4 m (18 – 44').
- Kits include car and end controls; purchase track and fasteners separately.



Ball or roller bearing control block options

- Stand-up toggles with ears attach Carbo or Black Magic control blocks for 2:1 up to 6:1 systems.
- Pair with Carbo ball bearing end controls for reduced friction and smooth-running system.
- Carbo-Cam or Cam-Matic cleats keep weight minimal.



Ball bearing end control

Sleeve bearing control block options

- Cars feature built-in sleeve bearing control blocks for value-oriented options for installation of 2:1 to 4:1 systems.
- Pair with sleeve bearing end controls for durability and strength.
- Carbo-Cam or Cam-Matic cleats keep weight minimal.

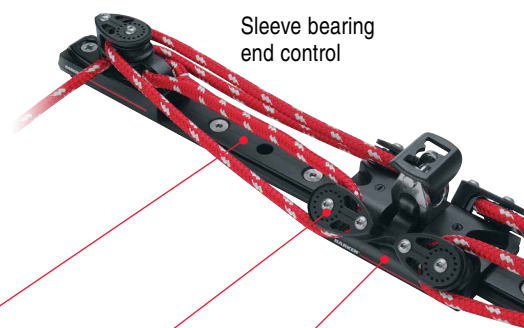

Sleeve bearing end control



6061-T6 aluminum:
Hardcoat-anodized track



Carbo composite:
Control blocks



6061-T6 aluminum:
Hard Lube-anodized car bodies

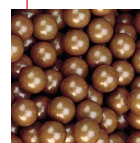

Torlon:
Ball bearings

Materials
For properties see pages 253-254.

13 mm Micro: CB Track & Accessories

Track

Track comes in low- and high-beam configurations, and is predrilled with holes for mounting fasteners.

Endstops

Endstops absorb shock loads. Use the built-in groove to deadend 2:1 control line. Sold in pairs. Fasteners not included.

Splice Links

Splice links join track and keep it aligned during installation.

Curved Track

Harken will bend track to your specifications. See page 125.



2706

2710

LINE-SHEDDING ENDSTOPS

2711



SPLICE LINKS

LOW-BEAM



HIGH-BEAM DRILLED



13 mm High-Beam
Track Spanning Chart

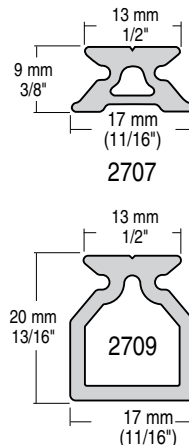
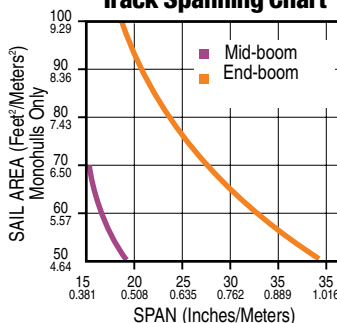

Track bending

Track	Minimum radius Horizontal bend*	
	in	m
2707	60	1.52
2709	60	1.52

*Horizontal only. Contact Harken Tech Service for vertical bends.

Track	Fastener hole distance from track end	
	in	mm
2707	1	25
2709	1 15/16	50

470 © US Sailing Team / Will Ricketson

Part No.	Description	Length		Mounting hole spacing		Weight		Fasteners (FH)		Line-shedding endstop†	Splice link
		ft/in	m	in	mm	oz	g	in	mm		
Metric Track											
2707.600MM	Low-beam	2'	0.6	1 31/32	50	4.6	129	#8	4	2706	2711
2707.1M	Low-beam	3' 3"	1	1 31/32	50	7.6	214	#8	4	2706	2711
2707.1.2M	Low-beam	3' 11"	1.2	1 31/32	50	9	257	#8	4	2706	2711
2707.2M	Low-beam	6' 7"	2	1 31/32	50	15.1	429	#8	4	2706	2711
2707.2.5M	Low-beam	8' 2"	2.5	1 31/32	50	18.9	536	#8	4	2706	2711
2709.1M	High-beam	3' 3"	1	3 15/16	100	13.2	375	#8	4	2710	
2709.1.2M	High-beam	3' 11"	1.2	3 15/16	100	15.8	449	#8	4	2710	
2709.2M	High-beam	6' 7"	2	3 15/16	100	26.4	749	#8	4	2710	

†Sold in pairs.

13 mm Micro: CB Cars

Harken Micro CB traveler cars are used on small dinghies and catamarans.

About CB traveler cars: see feature pages at beginning of this section.



2701



E-Scow, 2015 Blue Chip Regatta



Block not included

Loop cars matched with 29 or 40 mm Carbo T2 blocks attached with high-tech line provide the ultimate lightweight, low-profile system.



Pivoting shackle cars have low pivot points to handle nonvertical loads.



2702

2700

2703

2767



2705

2704

16 mm control blocks spin on stainless steel balls that roll freely under high loads. The step-down design keeps the controls low and clear of the mainsheet block.

CARS

Cars

Part No.	Description	Length		Width		Car body height		Weight		Maximum working load		Breaking load	
		in	mm	in	mm	in	mm	oz	g	lb	kg	lb	kg
2701	Pivoting shackle/control blocks	3 7/16	87	1 9/16	40	3/4	19	2.56	73	310	140	1500	680
2703	Loop	2 3/16	56	1 9/16	40	3/4	19	1.6	45	310	140	1500	680
2700	Pivoting shackle	2 3/16	56	1 9/16	40	3/4	19	1.76	50	310	140	1500	680
2702	Pivoting shackle/tangs	2 3/8	61	1 9/16	40	3/4	19	2.08	59	310	140	1500	680
2767	Athwartships loop	2 3/16	56	1 9/16	40	3/4	19	1.48	42	310	140	1500	680

See page 271 for replacement balls.

Car Controls

Part No.	Description	Sheave Ø		Length		Weight		Max line Ø		Maximum working load		Breaking load		Purchase
		in	mm	in	mm	oz	g	in	mm	lb	kg	lb	kg	
2704	Control block (pair)	5/8	16	1 5/16	33	0.39	11	7/32	5	250	113	750	339	2:1
2705	Control tang (pair)			13/16	21	0.11	3			250	113	750	339	1:1

22 mm Small Boat: CB Track & Accessories

Variable Hole Spacing Track

CB (Captive Ball) high-beam variable hole spacing track is used to span cockpits or other unsupported areas. Track features internal slide bolts, allowing new track to be installed without drilling additional holes.

High-Beam Drilled Track

374 and 2725 high-beam track is predrilled with holes for mounting fasteners.

Low-Beam Track

Low-beam track is available with or without pinstop holes.

Endstops/Trim Caps

When end controls are not used, add endstops to absorb shock loads. When end control assemblies are used, trim caps finish track ends. Sold in pairs. Fasteners not included.

Splice Links

Splice links join track and keep it aligned during installation.

Curved Track

Harken will bend track to your specifications. See page 125.

22 mm High-Beam Track Spanning Chart

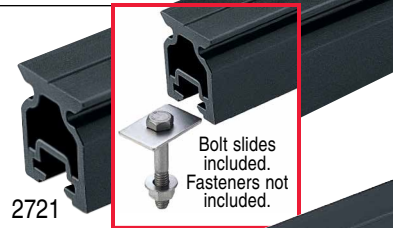
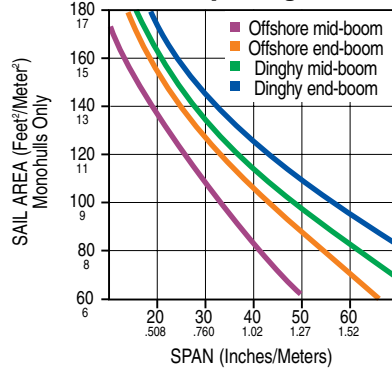

2721

374
2725

373
2720
2751

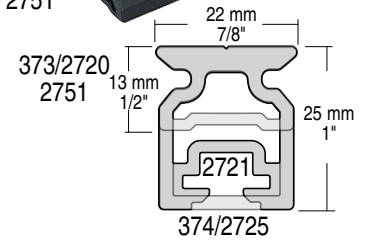

Track	in	mm
Metric	1 15/16	50
Retrofit	2	51

Track Bending

Cars	Minimum radius			
	Horizontal bend		Vertical bend	
	in	m	in	m
2726 - 2734, 2744 - 2745	42	1.07	65	1.65
2735 - 2738, 2746, 2735.NW	80	2.03	94	2.38
2726.NW, 2727.NW, 2754.NW	42	1.07	42	1.07

Part No.	Description	Length ft/in	m	Mounting hole spacing*	in	mm	Weight oz	g	Fasteners in	mm	High-load endstop**‡	Low-load/ line-shedding endstop‡	Splice link/ trim cap‡
Metric Track													
2720.600MM	Low-beam	1' 11 5/8"	0.6	3 15/16	100	9.1	258	10FH	5FH	263/E2200	173/446‡‡	173/446‡‡	2724/2722
2720.1M	Low-beam	3' 3 3/8"	1	3 15/16	100	15.2	430	10FH	5FH	263/E2200	173/446‡‡	173/446‡‡	2724/2722
2720.1.2M	Low-beam	3' 11 1/4"	1.2	3 15/16	100	18.2	516	10FH	5FH	263/E2200	173/446‡‡	173/446‡‡	2724/2722
2720.1.5M	Low-beam	4' 11 1/16"	1.5	3 15/16	100	22.8	645	10FH	5FH	263/E2200	173/446‡‡	173/446‡‡	2724/2722
2720.1.8M	Low-beam	5' 10 13/16"	1.8	3 15/16	100	27.3	775	10FH	5FH	263/E2200	173/446‡‡	173/446‡‡	2724/2722
2720.2.1M	Low-beam	6' 10 11/16"	2.1	3 15/16	100	31.9	904	10FH	5FH	263/E2200	173/446‡‡	173/446‡‡	2724/2722
2720.2.5M	Low-beam	8' 2 7/16"	2.5	3 15/16	100	38	1077	10FH	5FH	263/E2200	173/446‡‡	173/446‡‡	2724/2722
2720.3M	Low-beam	9' 10 1/16"	3	3 15/16	100	45.5	1291	10FH	5FH	263/E2200	173/446‡‡	173/446‡‡	2724/2722
2720.3.6M	Low-beam	11' 9 3/4"	3.6	3 15/16	100	54.6	1549	10FH	5FH	263/E2200	173/446‡‡	173/446‡‡	2724/2722
2720.6M	Low-beam***	19' 8 1/4"	6	3 15/16	100	91.1	2582	10FH	5FH	263/E2200	173/446‡‡	173/446‡‡	2724/2722
2725.1M	High-beam	3' 3 3/8"	1	3 15/16	100	21	586	10FH	5FH	264	174/	174/	/2723
2725.1.2M	High-beam	3' 11 1/4"	1.2	3 15/16	100	24.5	695	10FH	5FH	264	174/	174/	/2723
2725.1.5M	High-beam	4' 11 1/16"	1.5	3 15/16	100	31	879	10FH	5FH	264	174/	174/	/2723
2725.1.8M	High-beam	5' 10 13/16"	1.8	3 15/16	100	37	1055	10FH	5FH	264	174/	174/	/2723
2725.3.6M	High-beam***	11' 9 3/4"	3.6	3 15/16	100	74	2110	10FH	5FH	264	174/	174/	/2723
2751.600MM													
2751.1M	Low-beam/pinstop holes	1' 11 5/8"	0.6	3 15/16	100	8.9	252	#10	5	263/E2200	173/446‡‡	173/446‡‡	2724/2722
2751.1.5M	Low-beam/pinstop holes	3' 3 3/8"	1	3 15/16	100	14.8	420	#10	5	263/E2200	173/446‡‡	173/446‡‡	2724/2722
2751.1.8M	Low-beam/pinstop holes	4' 11 1/16"	1.5	3 15/16	100	22.2	629	#10	5	263/E2200	173/446‡‡	173/446‡‡	2724/2722
2751.2M	Low-beam/pinstop holes	6' 6 3/4"	2	3 15/16	100	29.6	838	#10	5	263/E2200	173/446‡‡	173/446‡‡	2724/2722
2751.3.6M	Low-beam/pinstop holes	11' 9 3/4"	3.6	3 15/16	100	53.3	1510	#10	5	263/E2200	173/446‡‡	173/446‡‡	2724/2722
Variable Hole Spacing Track													
2721.1.2M	High-beam	3' 11 1/4"	1.2	Pletina deslizante	30	851		5HH	264		174/	174/	/2723
2721.1.5M	High-beam	4' 11 1/16"	1.5	Pletina deslizante	37.5	1064		5HH	264		174/	174/	/2723
2721.1.8M	High-beam	5' 10 13/16"	1.8	Pletina deslizante	45	1277		5HH	264		174/	174/	/2723
2721.3.6M	High-beam***	11' 9 3/4"	3.6	Pletina deslizante	90.1	2554		5HH	264		174/	174/	/2723
Retrofit 4" Hole Spacing Track													
373.6	Low-beam	6'	1.83	4	102	28	787	10FH	5FH	263/E2200	173/446‡‡	173/446‡‡	2724/2722
373.12	Low-beam	12'	3.66	4	102	56	1574	10FH	5FH	263/E2200	173/446‡‡	173/446‡‡	2724/2722
374.4	High-beam	4'	1.22	4	102	25	709	10FH	5FH	264	174/	174/	/2723
374.6	High-beam	6'	1.83	4	102	38	1077	10FH	5FH	264	174/	174/	/2723
374.12	High-beam***	12'	3.66	4	102	76	2143	10FH	5FH	264	174/	174/	/2723

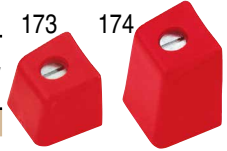

*First mounting hole distance from end of track: Metric track = 50 mm (1 31/32"); Retrofit 4" hole spacing track = 51 mm (2").

22 mm Small Boat: CB Cars

Small Boat CB traveler cars fit dinghies, keelboats, beachcats, and offshore boats to 8 m (27').

About CB traveler cars: see feature pages at beginning of this section.



2726
2727



Block not included

Loop cars matched with 29 or 40 mm Carbo T2 blocks attached with high-tech line provide the ultimate lightweight, low-profile system.



Blocks attach directly to the toggle for a low-profile, compact system.

Pivoting shackle and toggle cars have low pivot points to handle nonvertical loads.



The 382 radial car has been redesigned. The new product, 2769, has a captive ball bearing system and the car is now designed for soft attach blocks for better alignment with loads. Its curved race fits track that has been curved for applications like radial vang on the International Star.

Delrin is a registered trademark of E. I. du Pont de Nemours and Company or its affiliates.

Part No.	Description	Length		Width		Car body Height		Weight	Mainsheet block pin Ø				Maximum working load		Breaking load		
		in	mm	in	mm	in	mm		in	mm	in	mm	in	mm	lb	kg	lb
2726*	Low-load/pivoting shackle**	2 7/8	73	2 1/4	57	15/16	24	4.6	132					500	227	2500	1134
2727*	Pivoting shackle	2 7/8	73	2 1/4	57	15/16	24	4.6	132					850	386	2500	1134
2728*	Low-load/adjusted sheaves/eyestraps**	2 7/8	73	2 1/4	57	15/16	24	5.6	159					500	227	2500	1134
2729	Fixed sheaves/eyestraps	2 7/8	73	2 1/4	57	15/16	24	5.6	159					850	386	2500	1134
2730	Low-load/stand-up toggle**	2 7/8	73	2 1/4	57	15/16	24	5.1	145	3/16	5	5/32	4	500	227	2500	1134
2731	Stand-up toggle	2 7/8	73	2 1/4	57	15/16	24	5.1	145	3/16	5	5/32	4	850	386	2500	1134
2732	Low-load/loop**	2 7/8	73	2 1/4	57	15/16	24	4	113					500	227	2500	1134
2733	Loop	2 7/8	73	2 1/4	57	15/16	24	4	113					850	386	2500	1134
2734	Fixed sheaves/adjustable arms/365 Carbo-Cam	6 3/4	171	3 1/8	80	15/16	24	14.4	422					850	386	2500	1134
2734HL	High-load/adjusted sheaves/adjustable arms/365 Carbo-Cam	6 3/4	171	3 1/8	80	15/16	24	23.4	664					1250	567	2500	1134
2735*	High-load/pivoting toggle	4 1/8	105	2 1/4	57	15/16	24	6.7	191	1/4	6	5/32	4	1250	567	2500	1134
2736*	High-load/adjusted sheaves/eyestraps	4 1/8	105	2 1/4	57	15/16	24	7.0	200					1250	567	2500	1134
2753	Low-load/pivoting shackle/control tangs**	2 7/8	73	2 1/4	57	15/16	24	5.3	150			3/16	5	500	227	2500	1134
2754*	Pivoting shackle/control tangs	2 7/8	73	2 1/4	57	15/16	24	5.3	150			3/16	5	850	386	2500	1134
2756	Pivoting sheaves/471 Carbo-Cam	2 7/8	73	2 1/4	57	15/16	24	9.84	279					850	386	2500	1134
2757*	High-load/pivoting sheaves/365 Carbo-Cam/eyestraps	4 1/8	105	2 1/4	57	15/16	24	14.2	401					1250	567	2500	1134
2765	High-load/pivoting sheaves/eyestraps	4 1/8	105	2 1/4	57	15/16	24	9.6	272					1250	567	2500	1134
2766	High-load/pivoting sheaves/swivel/150 Cam-Matic	4 1/8	105	6 1/8	156	15/16	24	22.2	630					1250	567	2500	1134
2768	Athwartships loop	2 7/8	73	2 1/4	57	15/16	24	3.7	104					850	386	2500	1134
2769	Loop - R28in Horizontal Bend‡	2 7/8	73	2 1/4	57	15/16	24	4	113					850	386	2500	1134

*Available as a non-CB car on a car loader to run on a non-CB style track supplied before 2002. Add .NW to end of part number.

**Small Boat low-load cars with a 227 kg (500 lb) maximum working load use Delrin® balls. See page 275 for replacement balls.

‡For horizontal curved track only — 710 mm (28 in) radius.

22 mm Small Boat: End Controls

About Carbo ball bearing or ESP sleeve bearing end controls: see feature pages at beginning of this section.



Carbo ball bearing end controls have an integrated bar for deadending control line.



Assemblies secure to track, eliminating additional holes.

Tough one-piece bases and cam arms are machined from a single piece of aluminum.



2741



Boomerang², Tofinou 8, 8 m (26.25'), Chantier Naval Latitude 46, naval architect: Joubert / Nivellet © Chantier Naval Latitude 46



2740

2742



2743

2755



E2230

E2250

CARBO BALL BEARING END CONTROLS

ESP SLEEVE BEARING END CONTROLS

Part No.	Description	Sheave Ø		Length		Width		Weight (pair)		Max line Ø		Height above track		Maximum working load		Breaking load		Purchase	
		in	mm	in	mm	in	mm	oz	g	in	mm	in	mm	lb	kg	lb	kg		
Carbo Ball Bearing End Controls																			
2740	Single sheave (pair)	1 1/8	29	3 7/16	87	1 3/8	35	8	228	5/16	8	1 1/32	26	300	136	600	272	2:1	
2741	Single sheave/471 Carbo-Cam (pair)	1 1/8	29	3 7/16	87	3 1/8	80	10.8	306	1/4	6	1 1/16	28	300	136	600	272	2:1	
2742	Double sheave (pair)	1 1/8	29	3 7/16	87	1 3/8	35	10.3	292	5/16	8	1 5/8	41	600	272	1200	544	3:1 / 4:1	
2743	Double sheave/471 Carbo-Cam (pair)	1 1/8	29	3 7/16	87	3 1/8	80	13	370	1/4	6	1 5/8	41	600	272	1200	544	3:1 / 4:1	
2755	Pinstop*			1 5/8	42	1 3/8	35	1.6**	45**			13/16	21						
ESP Sleeve Bearing End Controls																			
E2230	Single sheave/deadend (pair)	1	25	3 1/2	89	1 1/2	38	4.4	126	5/16	8	1	25	600	272	1200	544	1:1 / 2:1	
E2250	Double sheave/deadend (pair)	1	25	3 1/2	89	1 1/2	38	5	142	5/16	8	1 5/8	41	600	272	1200	544	3:1 / 4:1	

*Use with 2751 Small Boat pinstop track. **Weight each.

22 mm Small Boat: Car Accessories

Accessories

The 384 traveler block features high-load composite bearings to handle wire and high-strength line.

Stand-up toggles hold blocks upright on travelers. Control tangs allow attachment of control blocks.

Refer to stand-up toggles chart for mainsheet block compatibility. See purchase selection guide for control blocks.

Replacement Traveler Kits

Replacement traveler kits are the easiest way to restore modern traveler function. Kits come in two purchase options with prematched parts for easy retrofits.



2749



175



2759



2747
2748

STAND-UP
TOGGLES



2763



2764

REPLACEMENT
TRAVELER KITS



ACCESSORIES

Accessories

Part No.	Description	Sheave		Length		Width		Weight (pair)		Max line		Maximum working load		Breaking load		Purchase
		Ø in	mm	in	mm	in	mm	oz	g	Ø in	mm	lb	kg	lb	kg	
175	Coupler			3 11/16	94	2 3/16	56	4.5**	128**			1500	680	2500	1134	
2749	Control tangs (pair)			7/8	23			0.8	21			600	272	1200	544	2:1
2759	Padeye/fits 22 mm cars with sheaves			2 1/4	56	3/4	18	1.3**	38**							

**Weight each.

Stand-Up Toggles

Part No.	Description	Mainsheet block pin Ø		Control block pin Ø		Height		Weight		Maximum working load		Accepts mainsheet blocks
		in	mm	in	mm	in	mm	oz	g	lb	kg	
2747	Small stand-up toggle/control tangs	3/16	5	5/32	4	1 13/16	45	1.5	43	1250	567	40 mm double & triple Carbo, 57 mm single & fiddle Carbo
2748	Large stand-up toggle/control tangs	1/4	6	5/32	4	2	51	2	48	1250	567	57 mm double & triple Carbo

Replacement Traveler Kits

Part No.	Description	Boat length				Max mainsail area				Maximum working load		Purchase	Includes
		Mid-boom		End-boom		Mid-boom		End-boom		lb	kg		
		ft	m	ft	m	ft²	m²	ft²	m²				
2763	22 mm traveler kit/2:1	18 - 22	5.5 - 6.7	21 - 25	6.4 - 7.6	125	11.5	150	14	850	386	2:1	(1) 2729, (1 pair) 2741
2764	22 mm traveler kit/3:1	21 - 26	6.4 - 7.9	24 - 29	7.3 - 8.8	150	14	190	17.5	1250	567	3:1	(1) 2735, (2) 348, (1 pair) 2743

22 mm Small Boat: Purchase Selection Guide

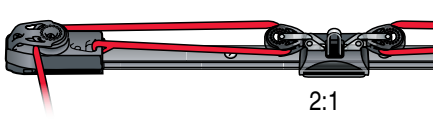

2:1

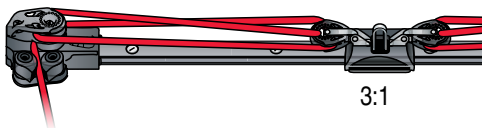

3:1

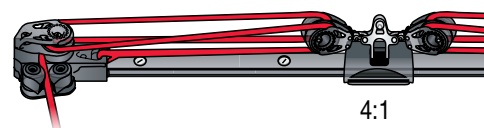

4:1

Purchase	Car	End control	Control block (cars with stand-up toggles or control tangs only)
2:1	2728 / 2729 / 2730 / 2731 / 2734 / 2753 / 2754 / 2735 / 2736 / 2737 / 2738	2740 / 2741	340 / 348 / 2608 / 2636 / 2650 / 2149
3:1	2730 / 2731 / 2753 / 2754 / 2735	2742 / 2743	340* / 341 / 348* / 2609 / 2636* / 2637 / 2650*
4:1	2730 / 2731 / 2753 / 2754 / 2735	2742 / 2743	342 / 2638 / 2642

*Deadend line through center of sheave.

22 mm Small Boat: Genoa Lead Cars

CB adjustable genoa lead cars feature recirculating Torton® ball bearings for easy adjustment under full sheet loads.

Stainless steel sheave carriers pivot 60 degrees to accommodate changing lead angles. Wide sheave holds two sheets during sail changes.

Cars feature car-mounted, sleeve-bearing control blocks for strength and durability. All CB genoa lead cars are compatible with Harken end controls. Kits are available for purchase upgrades up to 4:1.

CB Adjustable Cars

Sheave carriers feature high-performance sheaves with ball bearings to handle radial loads, while sideload balls handle thrust loads for easy trimming and fore-and-aft adjustment.

ESP CB Adjustable & Pinstop Cars

Sheave carriers feature ESP sleeve bearing sheaves.

Use pinstop cars in applications where lead positions change infrequently.

Pinstop and ball bearing genoa lead cars both run on ball bearing track, allowing system upgrades without changing track.

Torton is a registered trademark of Solvay Advanced Polymers L.L.C.



G2227B
CB ADJUSTABLE

G2247B

G222B

G224B
ESP CB ADJUSTABLE



2750

2750/2151/369

G226S
ESP PINSTOP



Flexible, lightweight, lashing attachment allows block to articulate freely on 2750 jib car.

GENOA LEADS Q&A

WHY DO I NEED ADJUSTABLE GENOA LEAD CARS?

If you are a cruiser, ball bearing genoa lead cars with multipart purchases allow you to quickly adjust loaded headsail leads from the cockpit. If you race, ball bearing lead cars let you quickly change your sheeting angle, adjusting the twist to optimize sail shape.

For sheet-loading formulas see page 279

End control selection guide

Purchase	Car	End Control
2:1	G2227B/G222B	2740
4:1	G2247B/G224B	2742

Part No.	Description	Sheave Ø		Length		Width		Weight		Maximum working load		Breaking load		Track
		in	mm	in	mm	in	mm	oz	g	lb	kg	lb	kg	
CB Adjustable														
G2227B*	Small Boat/sheave	1 3/4	45	4 1/8	105	2 1/4	57	13.71	389	1250	567	2500	1134	22 mm
G2247B	Small Boat/2 sheaves	1 3/4	45	4 1/8	105	2 1/4	57	14.3	405	1250	567	2500	1134	22 mm
ESP CB Adjustable														
G222B	Small Boat/sheave	1 1/2	38	4 1/8	105	2 1/4	57	12.87	365	1250	567	2500	1134	22 mm
G224B	Small Boat/2 sheaves	1 1/2	38	4 1/8	105	2 1/4	57	13.33	378	1250	567	2500	1134	22 mm
ESP Pinstop														
2750	Small Boat jib lead/pinstop			3 7/16	88	1 5/16	33	4.6	130	1100	500	2200	1000	2751
2750/2151/369	Small Boat/pinstop/loop block/stand-up	2 1/4	57	3 3/8	84	1 5/16	33	6.9	195	792	359	2200	1000	2751
G226S	Small Boat/pinstop	1 1/2	38	3 3/4	95	1 3/8	35	9.59	272	1250	567	2500	1134	2751

*Available as a non-CB car on a car loader to run on a non-CB style track supplied before 2002. Add .NW to end of part number.

See page 276 for replacement balls.

27 mm Midrange: CB Track & Accessories

Variable Hole Spacing Track

CB (Captive Ball) high-beam variable hole spacing track is used to span cockpits or other unsupported areas. Track features internal slide bolts, allowing new track to be installed without drilling additional holes.

Low-Beam Track

Low-beam track is available with one, two, or three pinstop holes between fasteners or without pinstop holes.

Endstops/Trim Caps

When end controls are not used, add endstops to absorb shock loads. When end control assemblies are used, trim caps finish track ends. Sold in pairs. Fasteners not included.

Splice Links

Splice links join track and keep it aligned during installation.

Track Risers

Use 1849 risers for mid-boom travelers that must clear companionway hatches. Risers fit most cabintops and articulate for use with either straight or curved track. Sold in pairs.

Curved Track

Harken will bend track to your specifications. See page 125.

Track bending

Car	Minimum radius			
	Horizontal bend		Vertical bend	
	ft	m	ft	m
T27xxB, T2701B.NW, T27x4B.HL, 1635	8	2.44	8	2.44
T27xxB.HL, T2701B.HL.NW, 1636	9	2.73	9	2.73

Track Risers

Part No.	Description	Fits	Weight		A		B		C		D		E		F	
			oz	g	in	mm	in	mm	in	mm	in	mm	in	mm	in	mm
1849	Track riser (pair)	R27HB, R32HB	131.2	3720	6 7/8	175	9 9/16	243	6 11/16	170	4 5/16	110	1 3/4	45	3	76

Part No.	Description	Length	Mounting hole spacing*	Weight	Fasteners	Endstop**/trim cap**	Splice link/track riser

Metric Track											
R27.1M	Low-beam/pinstop holes	3' 3 3/8"	1	3 15/16	100	22	0.62	5/16FH	8FH	1522/E2700/1606/1621	1619/
R27.1MHDP	Low-beam/3 pinstop holes	3' 3 3/8"	1	3 15/16	100	21.3	0.61	5/16FH	8FH	1522/E2700/1606/1621	1619/
R27.1.2M	Low-beam/pinstop holes	3' 11 1/4"	1.2	3 15/16	100	26.5	0.75	5/16FH	8FH	1522/E2700/1606/1621	1619/
R27.1.5M	Low-beam/pinstop holes	4' 11 1/16"	1.5	3 15/16	100	33	0.93	5/16FH	8FH	1522/E2700/1606/1621	1619/
R27.1.8M	Low-beam/pinstop holes	5' 10 13/16"	1.8	3 15/16	100	39	1.11	5/16FH	8FH	1522/E2700/1606/1621	1619/
R27.2M	Low-beam/pinstop holes	6' 6 3/4"	2	3 15/16	100	44	1.24	5/16FH	8FH	1522/E2700/1606/1621	1619/
R27.2.5M	Low-beam/pinstop holes	8' 2 7/16"	2.5	3 15/16	100	55	1.56	5/16FH	8FH	1522/E2700/1606/1621	1619/
R27.3M	Low-beam/pinstop holes	9' 10 1/16"	3	3 15/16	100	66	1.87	5/16FH	8FH	1522/E2700/1606/1621	1619/
R27.3.6M	Low-beam/pinstop holes	11' 9 3/4"	3.6	3 15/16	100	79	2.24	5/16FH	8FH	1522/E2700/1606/1621	1619/
R27.6M	Low-beam/pinstop holes	19' 8 1/4"	6	3 15/16	100	132	3.74	5/16FH	8FH	1522/E2700/1606/1621	1619/

Variable Hole Spacing Track										
R27HB.1M	High-beam	3' 3 3/8"	1	Slide bolt	57	1.63	1/4HH	6HH	1523/1622	/1849
R27HB.1.5M	High-beam	4' 11 1/16"	1.5	Slide bolt	86	2.45	1/4HH	6HH	1523/1622	/1849
R27HB.1.8M	High-beam	5' 10 7/8"	1.8	Slide bolt	104	2.93	1/4HH	6HH	1523/1622	/1849
R27HB.2.5M	High-beam	8' 2 7/16"	2.5	Slide bolt	144	4.08	1/4HH	6HH	1523/1622	/1849
R27HB.3.6M	High-beam***	11' 9 3/4"	3.6	Slide bolt	207	5.87	1/4HH	6HH	1523/1622	/1849

Retrofit 4" Hole Spacing Track											
1602.8	Low-beam	8'	2.44	4	102	56	1.59	1/4FH	6FH	1522/E2700/1606/1621	1619/
1602.12	Low-beam	12'	3.66	4	102	83	2.35	1/4FH	6FH	1522/E2700/1606/1621	1619/
1605.4	Low-beam/2 pinstop holes	4'	1.22	4	102	26.9	0.76	1/4FH	6FH	1522/E2700/1606/1622	1619/
1605.6	Low-beam/2 pinstop holes	6'	1.83	4	102	40.3	1.14	1/4FH	6FH	1522/E2700/1606/1622	1619/

*First mounting hole distance from end of track: Metric track = 50 mm (1 31/32"); Retrofit 4" hole spacing track = 51 mm (2").

Sold in pairs. Trim caps not used with E27 end controls. *Contact Harken.

27 mm High-Beam Track Spanning Chart

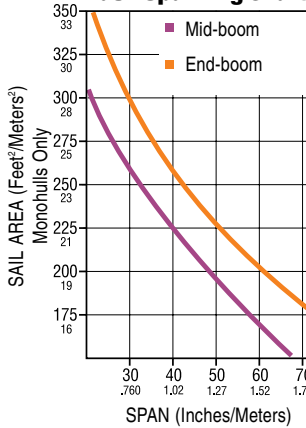

R27HB

R27
1605

1602

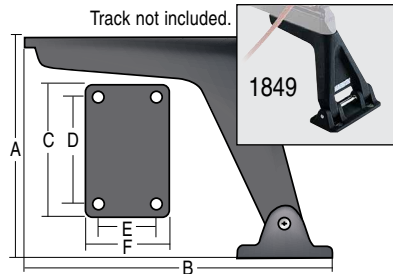
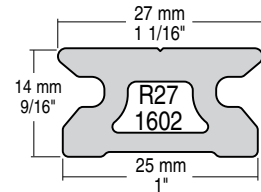
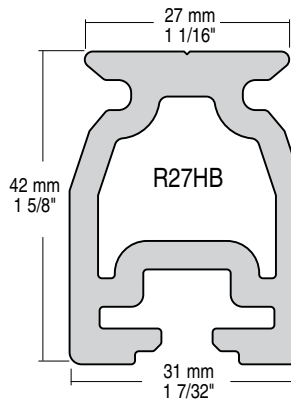

27 mm Midrange: CB Cars

Midrange CB traveler cars are built to handle high loads on boats from 8 m to 10 m (27' to 34').

About CB traveler cars: see feature pages at beginning of this section.



Carbo ball bearing controls

For a ball bearing system, use separate Carbo control blocks mounted on the stand-up toggle control tangs to add up to 4:1 purchase. See page 110.



T2703B



T2703B.HL



ESP sleeve bearing controls

For an ESP sleeve-bearing system, use a T27KIT control block kit mounted on the car to add up to 4:1 purchase. See page 110.



T2701B



T2701B.HL



T2705B.HL

T2705B



Complete selection of cars with built-in car control blocks is available online: www.harken.com/27mm-cars



T2721B.HL

T2731B.HL

T2741B.HL

T2721B

T2731B

T2741B

T2751B

T2704B.HL

Part No.	Description	Length		Width		Height		Weight oz g	Mainsheet block pin Ø		Control block pin Ø		Maximum working load		Breaking load	
		in	mm	in	mm	in	mm		in	mm	in	mm	lb	kg	lb	kg
27 mm Midrange Standard																
T2701B*	Car/shackle	4 1/4	108	2 3/4	70	2	50	11.04 313					1800	816	5000	2268
T2703B	Car/stand-up toggle/ears	4 1/4	108	2 3/4	70	3 1/8	80	14.4 408	1/4, 5/16	6, 8	3/16	5	1800	816	5000	2268
T2705B	Car/soft attachment	4 1/4	108	2 3/4	70	1 1/2	38	10.06 285					1800	816	5000	2268
T2721B	Car/shackle/2:1 ESP controls	4 1/4	108	3	76	2	50	11.04 313					1800	816	5000	2268
T2731B	Car/shackle/3:1 ESP controls	4 1/4	108	3 7/32	81	2	50	11.04 313					1800	816	5000	2268
T2741B	Car/shackle/4:1 ESP controls	4 1/4	108	3 3/8	86	2	50	11.04 313					1800	816	5000	2268
T2751B	Car/shackle/5:1 ESP controls	4 1/4	108	3 9/16	91	2	50	12.7 360					1800	816	5000	2268
27 mm Midrange High-Load																
T2701B.HL*	High-load car/shackle	5 3/16	132	2 3/4	70	2	50	12.48 354					2300	1043	5000	2268
T2703B.HL	High-load car/stand-up toggle/ears	5 3/16	132	2 3/4	70	3 1/8	80	15.84 449	1/4, 5/16	6, 8	3/16	5	2300	1043	5000	2268
T2704B.HL	2 cars/2 stand-up toggles	8 3/4	223	2 3/4	70	3 1/8	80	25.6 726	1/4, 5/16	6, 8			3600	1633	7200	3266
T2705B.HL	High-load car/soft attachment	5 3/16	132	2 3/4	70	1 1/2	38	12.28 348					2300	1043	5000	2268
T2721B.HL	High-load car/shackle/2:1 ESP controls	5 3/16	132	3	76	2	50	12.48 354					2300	1043	5000	2268
T2731B.HL	High-load car/shackle/3:1 ESP controls	5 3/16	132	3 7/32	81	2	50	12.48 354					2300	1043	5000	2268
T2741B.HL	High-load car/shackle/4:1 ESP controls	5 3/16	132	3 3/8	86	2	50	12.48 354					2300	1043	5000	2268

*Available as a non-CB car on a car loader to run on a non-CB style track supplied before 2003. Add .NW to end of part number.

See page 275 for replacement balls.

27 mm Midrange: End Controls

About Carbo ball bearing or ESP sleeve bearing end controls: see feature pages at beginning of this section.

Pogo 36, 10.86 m (36'), Pogo Structures, naval architect: FINOT-CONQ © Andreas Lindlahr



1631



PINSTOPS

1649

1642



1632



1633



1652

CARBO BALL BEARING END CONTROLS



E2730



E2750



E2756



E2750HB

ESP SLEEVE BEARING END CONTROLS

Fasteners not included.



Carbo ball bearing end controls have an integrated bar for deadending control line.



Assemblies secure to track, eliminating additional holes.

Tough one-piece bases and cam arms are machined from a single piece of aluminum.



Use E2750HB double-sheave ESP end controls for cabintop travelers where lines lead to the aft edge of the cabintop.

Contact Harken to order special length track with mounting holes for E2750HB end controls.

Part No.	Description	Sheave Ø		Length		Width		Weight (pair)		Max line Height above track		Maximum working load		Breaking load		Purchase		
		in	mm	in	mm	in	mm	oz	g	in	mm	in	mm	lb	kg		lb	kg
Carbo Ball Bearing End Controls																		
1631	Single sheave (pair)*	1 9/16	40	4 1/2	114	1 15/16	49	20	574	3/8	10	1 5/16	33	350	159	875	397	2:1 / 3:1
1632	Double sheave (pair)*	1 9/16	40	4 1/2	114	1 15/16	49	26	730	3/8	10	2	50	700	318	1750	794	3:1 / 4:1
1633	Double sheave/365 Carbo-Cam (pair)*	1 9/16	40	4 1/2	114	3 15/16	100	36	1020	3/8	10	2	50	600	272	1500	680	3:1 / 4:1
1652	Self-tacking jib controls (pair)***	2	51	4 3/16	106	2 1/4	57	20.4	578	1/2	12	2 5/16	59	610	277	1200	544	1:1
ESP Sleeve Bearing End Controls																		
E2730	Single sheave/deadend (pair)	1 3/8	35	4 13/16	122	1 13/16	45	19.54	554	3/8	10	1 7/16	36	1800	816	3600	1633	1:1 / 2:1
E2750HB	High-beam double sheave (pair)‡	1 9/16	40	4 1/4	108	1 9/16	40	23.4	662	3/8	10	1	25	600	272	1200	544	3:1 / 4:1
E2750	Double sheave/deadend (pair)	1 3/8	35	4 13/16	122	1 13/16	45	24.2	686	3/8	10	2 1/4	56	1800	816	3600	1633	3:1 / 4:1
E2756	Double sheave/deadend/365 Carbo-Cam (pair)‡‡	1 3/8	35	3 3/4	95	3 13/16	96	23.4	1278	3/8	10	2 1/4	56	600	272	1500	680	4:1
Pinstops																		
1642	Pinstop			2 5/16	59	1 15/16	49	4.8**	136**			1 5/16	33					
1649	Pinstop/shackle			3 1/2	89	1 15/16	49	9.95**	282**					1984	900	3968	1800	

*Includes 8 mm PH fasteners. **Weight each. ***Includes 5/16" RH fasteners. ‡Requires high-beam track.

‡‡Maximum working loads and breaking loads based on cam strengths.

27 mm Midrange: Car Accessories

Control Block Kits

Kits are available for Midrange cars to add sleeve-bearing control systems for up to 4:1 purchase. Combine with sleeve-bearing end controls.

Stand-Up Toggles

Stand-up toggles hold blocks upright on travelers. Control tangs allow attachment of ball bearing Carbo control blocks.

Refer to stand-up toggles chart for mainsheet block compatibility. See purchase selection guide for control blocks.

Replacement Traveler Kits

Replacement traveler kits are the easiest way to restore modern traveler function. Kits come in two purchase options with prematched parts for easy retrofits.



1654



1655

REPLACEMENT TRAVELER KITS



1567



1643

STAND-UP TOGGLES



2650

2638

See page 20-21



T27KIT
T32KIT

Control Block Kits

Part No.	Description	Includes
T27KIT	Purchase upgrade kit **	(4) 25 mm control blocks, (2) Small Boat deadends, (8) M5 fasteners
T32KIT	Purchase upgrade kit ‡	(4) 35 mm control blocks, (2) Midrange/Big Boat deadends, (8) M6 fasteners

*Use with G27 genoa lead cars. **Fits 25 mm sheave Ø.

‡ Fits 35 mm sheave Ø.

Replacement Traveler Kits

Part No.	Description	Boat length				Max mainsail area				Maximum working load		Purchase	Includes
		Mid-boom		End-boom		Mid-boom		End-boom		lb	kg		
1654	27 mm traveler kit/3:1	26 - 28	7.9 - 8.5	28 - 30	8.5 - 9.1	190	17.5	220	20.5	1800	816	3:1	(1) T2731B, (1 pair) E2756
1655	27 mm traveler kit/4:1	28 - 31	8.5 - 9.5	31 - 35	9.5 - 10.7	215	20	260	24	1800	816	4:1	(1) T2741B, (1 pair) E2756

Stand-Up Toggles

Part No.	Description	Mainsheet block pin Ø		Control block pin Ø		Height		Maximum working load		Accepts mainsheet blocks
		in	mm	in	mm	in	mm	lb	kg	
1567	Stand-up toggle	1/4, 5/16	6, 8			2 5/16	59	2500	1134	45 & 60 mm Element singles, doubles, triples; 75 mm Carbo singles, doubles, triples; 3" Small Boat single, fiddle, Midrange blocks; 57 mm single Black Magic
1643	Stand-up toggle/control tangs	1/4, 5/16	6, 8	3/16	5	2 5/16	59	2500	1134	

27 mm Midrange: Purchase Selection Guide

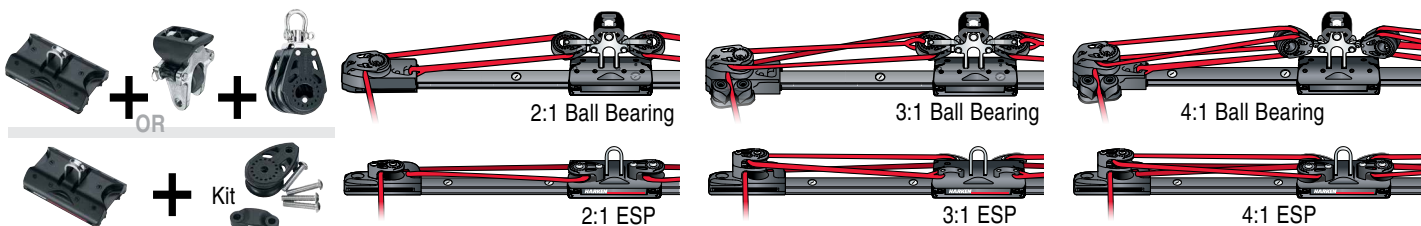

Purchase	Car	End control	Control block on car
2:1 Ball bearing	T2701B	1631	1643 with 2650
2:1 ESP	T2701B	E2730	T27KIT
3:1 Ball bearing	T2701B	1632, 1633	1643 with 2650*
3:1 ESP	T2701B	E2750, E2756	T27KIT
4:1 Ball bearing	T2701B	1632, 1633	1643 with 2638
4:1 ESP	T2701B	E2750, E2756	T27KIT

Control purchase recommendations					
Sail area					
End-boom sheeting		Mid-boom sheeting		Purchase	
ft²	m²	ft²	m²		
Under 140	Under 13	Under 125	Under 12	2:1	
140-235	13-22	125-200	12-19	3:1	
235-275	22-25	200-250	19-23	4:1	

*Deadend line through center of sheave.

27 mm Midrange: Genoa Lead Cars

CB adjustable genoa lead cars feature recirculating Torlon® ball bearings for easy adjustment under full sheet loads.

Stainless steel sheave carriers pivot 60 degrees to accommodate changing lead angles. Wide sheave holds two sheets during sail changes.

Cars feature car-mounted, sleeve-bearing control blocks for strength and durability. All CB genoa lead cars are compatible with Harken end controls. Kits are available for purchase upgrades up to 4:1.

CB Adjustable Cars

Sheave carriers feature high-performance sheaves with roller bearings to handle radial loads, while sideload balls handle thrust loads for easy trimming and fore-and-aft adjustment.

ESP CB Adjustable & Pinstop Cars

Sheave carriers feature ESP sleeve-bearing sheaves.

Use pinstop cars in applications where lead positions change infrequently.

Pinstop and ball bearing genoa lead cars both run on ball bearing track, allowing system upgrades without changing track.



ESP PINSTOP



Torlon is a registered trademark of Solvay Advanced Polymers L.L.C.



G2727B



G2737B



G2747B



G2737B.HL



G2747B.HL

CB ADJUSTABLE



G272B



G273B



G274B



G273B.HL



G274B.HL

ESP CB ADJUSTABLE

27 mm Midrange: Genoa Lead Cars



N Fun 30, 9.14 m (30'), naval architect: Eugeniusz Ginter © Tomasz Karolski / N Fun Yachting sp zoo

For sheet-loading formulas see page 279.

End control selection guide		
Purchase	Car	End control
2:1	G272B/G2727B	E2730
3:1	G273B/G273B.HL/G2737B/G2737B.HL	E2750
4:1	G274B/G274B.HL/G2747B/G2747B.HL	E2750

Part No.	Description	Sheave Ø		Length		Width		Weight		Maximum working load		Breaking load		Track
		in	mm	in	mm	in	mm	oz	g	lb	kg	lb	kg	
CB Adjustable														
G2727B	Midrange/sheave	2 1/2	64	5 3/16	132	2 3/4	70	27.52	780	2300	1043	5000	2268	R27
G2737B	Midrange/sheave/deadend	2 1/2	64	5 3/16	132	2 3/4	70	28.4	805	2300	1043	5000	2268	R27
G2737B.HL	High-load Midrange/sheave/deadend	2 1/2	64	9 1/8	232	2 3/4	70	39.25	1113	3600	1633	7200	3266	R27
G2747B*	Midrange/2 sheaves	2 1/2	64	5 3/16	132	2 3/4	70	29.76	844	2300	1043	5000	2268	R27
G2747B.HL	High-load Midrange/2 sheaves	2 1/2	64	9 1/8	232	2 3/4	70	40.64	1152	3600	1633	7200	3266	R27
ESP CB Adjustable														
G272B	Midrange/sheave	2	51	5 3/16	132	2 3/4	70	23.25	659	2300	1043	5000	2268	R27
G273B	Midrange/sheave/deadend	2	51	5 3/16	132	2 3/4	70	24.06	682	2300	1043	5000	2268	R27
G273B.HL	High-load Midrange/sheave/deadend	2 1/2	64	9 1/8	232	2 3/4	70	34.6	981	3600	1633	7200	3266	R27
G274B	Midrange/2 sheaves	2	51	5 3/16	132	2 3/4	70	25.22	718	2300	1043	5000	2268	R27
G274B.HL	High-load Midrange/2 sheaves	2 1/2	64	9 1/8	232	2 3/4	70	35.76	1017	3600	1633	7200	3266	R27
ESP Pinstop														
G276S	Midrange/pinstop	2	51	5	127	1 5/8	41	17.92	508	3000	1361	6000	2722	R27
G276S.HL	High-load Midrange/pinstop	2	51	7 1/4	184	1 5/8	41	22.93	650	3600	1633	7200	3266	R27

*Available as a non-CB car on a car loader to run on a non-CB style track supplied before 2003. Add .NW to end of part number.

See page 275 for replacement balls.

32 mm Big Boat: CB Track & Accessories

Variable Hole Spacing Track

CB (Captive Ball) high-beam variable hole spacing track is used to span cockpits or other unsupported areas. Track features internal slide bolts, allowing new track to be installed without drilling additional holes.

Low-Beam Track

Low-beam track is available with one, two, or three pinstop holes between fasteners or without pinstop holes.

Endstops/Trim Caps

When end controls are not used, add endstops to absorb shock loads. When end control assemblies are used, trim caps finish track ends. Sold in pairs. Fasteners not included.

Splice Links

Splice links join track and keep it aligned during installation.

Track Risers

Use 1849 risers for mid-boom travelers that must clear companionway hatches. Risers fit most cabintops and articulate for use with either straight or curved track.

Curved Track

Harken will bend track to your specifications. See page 125.

Track bending

Car	Minimum radius			
	Horizontal bend		Vertical bend	
	ft	m	ft	m
T32xxB*, T32xxB.NW, 3176, 3177	8	2.44	10	3.05
T32xxB.HL, T32x4B.HL T32xxB.HL.NW, 3178, 3179	18	5.49	18	5.49
2 x T32xxB, 2 x T32xxB.NW	8	2.44	10	3.05
T3204B, T3209B	24	7.32	24	7.32

*T3204B/T3209B: 7.32 m (24')

Part No.	Description	Length		Mounting hole spacing*		Weight oz	Weight kg	Fasteners		Endstop**/trim cap**	Splice link/track riser‡
		ft/in	m	in	mm			in	mm		
Metric Track											
R32.1M	Low-beam/pinstop holes	3' 3 3/8"	1	3 15/16	100	52	1.47	3/8FH	10FH	548/E3200/3157	3153/
R32.1MHDP	Low-beam/3 pinstop holes	3' 3 3/8"	1	3 15/16	100	33.1	0.94	5/16FH	8FH	548/E3200/3157	3153/
R32.1.5M	Low-beam/pinstop holes	4' 11 1/16"	1.5	3 15/16	100	52	1.47	3/8FH	10FH	548/E3200/3157	3153/
R32.1.8M	Low-beam/pinstop holes	5' 10 13/16"	1.8	3 15/16	100	61.7	1.75	3/8FH	10FH	548/E3200/3157	3153/
R32.2.1M	Low-beam/pinstop holes	6' 10 11/16"	2.1	3 15/16	100	72	2.05	3/8FH	10FH	548/E3200/3157	3153/
R32.2.4M	Low-beam/pinstop holes	7' 10 1/2"	2.4	3 15/16	100	81	2.3	3/8FH	10FH	548/E3200/3157	3153/
R32.3M	Low-beam/pinstop holes	9' 10 1/16"	3	3 15/16	100	103	2.93	3/8FH	10FH	548/E3200/3157	3153/
R32.3.6M	Low-beam/pinstop holes	11' 9 3/4"	3.6	3 15/16	100	124	3.52	3/8FH	10FH	548/E3200/3157	3153/
R32.6M	Low-beam/pinstop holes	19' 8 1/4"	6	3 15/16	100	207	5.87	3/8FH	10FH	548/E3200/3157	3153/
Variable Hole Spacing Track											
R32HB.1.5M	High-beam	4' 11 1/16"	1.5			167	4.74	5/16HH	8HH	562/3158	/1849
R32HB.1.8M	High-beam	5' 10 7/8"	1.8			201	5.69	5/16HH	8HH	562/3158	/1849
R32HB.2.5M	High-beam	8' 2 7/16"	2.5			279	7.9	5/16HH	8HH	562/3158	/1849
R32HB.3.6M	High-beam***	11' 9 3/4"	3.6			402	11.38	5/16HH	8HH	562/3158	/1849
R32HB.4.5M	High-beam***	14' 9 3/16"	4.5			502	14.23	5/16HH	8HH	562/3158	/1849
Retrofit 4" Hole Spacing Track											
3159.8	Low-beam	8'	2.44	4	102	89	2.48	5/16FH	8FH	548/E3200/3157	3153/
3159.12	Low-beam	12'	3.66	4	102	131	3.71	5/16FH	8FH	548/E3200/3157	3153/
3500.4	Low-beam/2 pinstop holes	4'	1.22	4	102	41.5	1.18	5/16FH	8FH	548/E3200/3157	3153/
3500.6	Low-beam/2 pinstop holes	6'	1.83	4	102	62.2	1.76	5/16FH	8FH	548/E3200/3157	3153/

*First mounting hole distance from end of track: Metric track = 50 mm (1 31/32"); Retrofit 4" hole spacing track = 51 mm (2").

Sold in pairs. Trim caps not used with E32 end controls. ‡Track riser 1849 shown on page 107. *Contact Harken.

32 mm High-Beam Track Spanning Chart

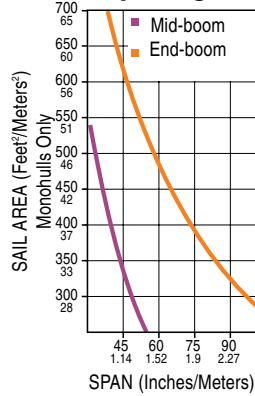

R32HB

R32
3500

3159

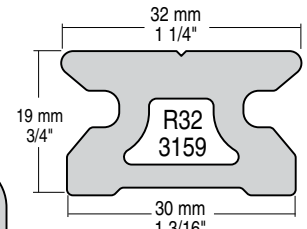
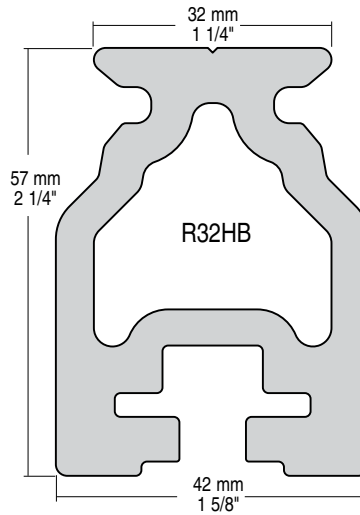
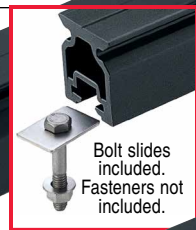

Track not included.



32 mm Big Boat: CB Cars

Big Boat CB traveler cars handle high loads on boats from 9.5 m to 15 m (32' to 50') and up to 21 m (70') with coupled cars.

About CB traveler cars: see feature pages at beginning of this section.



Carbo ball bearing controls

For a ball bearing system, use separate Carbo or Black Magic control blocks mounted on the stand-up toggle control tangs to add up to 6:1 purchase. See page 110.

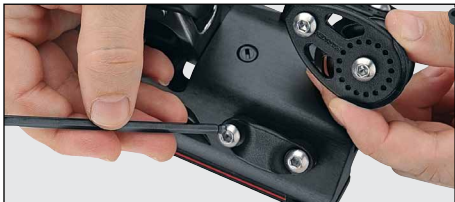

ESP sleeve bearing controls

For an ESP sleeve-bearing system, use a T32KIT control block kit mounted on the car to add up to 6:1 purchase. See page 110.



T3203B

T3203B.HL



T3201B

T3201B.HL



T3205B and T3205B.HL lightweight soft-attachment cars provide a variety of rigging solutions—athwartship jib or mainsheet systems, for example. Lash Carbo T2 or Black Magic Loop blocks to the car for traveler control.



T3205B.HL

T3205B



T3221B.HL

T3231B.HL

T3241B.HL

T3209B

T3204B

T3209B.HL

T3221B

T3231B

T3241B

T3204B.HL



Complete selection of cars with built-in car control blocks is available online: www.harken.com/32mm-cars

Part No.	Description	Length		Width		Height		Weight		Mainsheet block pin Ø		Control block pin Ø		Maximum working load		Breaking load	
		in	mm	in	mm	in	mm	oz	g	in	mm	in	mm	lb	kg	lb	kg
32 mm Big Boat Standard																	
T3201B*	Car/shackle	5 3/8	136	3 11/32	85	2 5/8	73	20	567					3000	1361	7000	3175
T3203B	Car/stand-up toggle/ears	5 3/8	136	3 11/32	85	3 1/2	89	25.28	717	5/16, 3/8 8, 10	1/4	6	3000	1361	7000	3175	
T3204B	Car/2 stand-up toggles	9 1/8	231	3 11/32	85	3 1/2	89	55	1559	5/16, 3/8 8, 10			5000	2268	10000	4536	
T3205B	Car/soft attachment	5 3/8	136	3 11/32	85	2	50	20.43	579				3000	1361	7000	3175	
T3209B	Car/2 stand-up toggles/ears	9 1/8	231	3 11/32	85	3 1/2	89	56.44	1600	5/16, 3/8 8, 10	1/4	6	5000	2268	10000	4536	
T3221B	Car/shackle/2:1 ESP controls	5 3/8	136	3 5/8	98	2 5/8	73	20	567				3000	1361	7000	3175	
T3231B	Car/shackle/3:1 ESP controls	5 3/8	136	4	101	2 5/8	73	20	567				3000	1361	7000	3175	
T3241B	Car/shackle/4:1 ESP controls	5 3/8	136	4 3/8	111	3 1/2	89	20	567				3000	1361	7000	3175	
32 mm Big Boat High-Load																	
T3201B.HL*	High-load car/shackle	7 7/16	188	3 11/32	85	2 5/8	73	24	680				4500	2041	9000	4081	
T3203B.HL	High-load car/stand-up toggle/ears	7 7/16	188	3 11/32	85	3 1/2	89	29.44	835	5/16, 3/8 8, 10	1/4	6	4500	2041	9000	4081	
T3204B.HL	2 high-load cars/2 stand-up toggles	15	381	3 11/32	85	3 1/2	89	79	2239	5/16, 3/8 8, 10			9000	4082	18000	8163	
T3205B.HL	High-load car/soft attachment	7 7/16	188	3 11/32	85	2	50	29.42	834				4500	2041	9000	4081	
T3209B.HL	2 high-load cars/2 stand-up toggles/ears	15	381	3 11/32	85	3 1/2	89	80.25	2275	5/16, 3/8 8, 10	1/4	6	9000	4082	18000	8163	
T3221B.HL	High-load car/shackle/2:1 ESP controls	7 7/16	188	3 5/8	98	2 5/8	73	24	680				4500	2041	9000	4081	
T3231B.HL	High-load car/shackle/3:1 ESP controls	7 7/16	188	4	101	2 5/8	73	24	680				4500	2041	9000	4081	
T3241B.HL	High-load car/shackle/4:1 ESP controls	7 7/16	188	4 3/8	111	3 1/2	89	24	680				4500	2041	9000	4081	

*Available as a non-CB car on a car loader to run on a non-CB style track supplied before 2004. Add .NW to end of part number.

See page 275 for replacement balls.

32 mm Big Boat: End Controls

About Carbo ball bearing or ESP sleeve bearing end controls: see feature pages at beginning of this section.



3170



Carbo ball bearing end controls have an integrated bar for deadending control line.



Assemblies secure to track, eliminating additional holes.

Tough one-piece bases and cam arms are machined from a single piece of aluminum.



3168

3169

3197



Use E3250HB double-sheave ESP end controls for cabintop travelers where lines lead to the aft edge of the cabintop.

Contact Harken to order special length track with mounting holes for E3250HB end controls.

CARBO BALL BEARING END CONTROLS



3174

3173

3173 and 3174 high-load controls allow 2:1 to 6:1 purchases on offshore boats with mainsails over 37 m² (400 ft²). Controls feature 57 mm Black Magic Big Boat ball/roller sheaves and high-load aluminum sideplates.

HIGH-LOAD END CONTROLS



3212

3304

3213

PINSTOPS



E3230
E3230.HL

E3250
E3250.HL

E3256

E3250HB

ESP SLEEVE BEARING END CONTROLS

End Controls: 32 mm Big Boat

TECH TIP

27 mm Midrange and 32 mm Big Boat kits are available for purchase upgrades from 1:1 to 4:1.



Amel 50, 15.24 m (50'), Berret-Racoupeau Yacht Design © Robin Christol

Control Purchase Recommendations				
Sail area				
End-boom sheeting		Mid-boom sheeting		Purchase
ft ²	m ²	ft ²	m ²	
Under 260	Under 24	Under 240	Under 22	3:1
260-450	24-42	240-400	22-37	4:1
450-600	42-56	400-550	37-51	6:1
Over 600	Over 56	Over 550	Over 51	2:1 w/winch

Part No.	Description	Sheave Ø		Length		Width		Weight (pair)		Max line Height above track		Maximum working load		Breaking load		Purchase				
		in	mm	in	mm	in	mm	oz	g	in	mm	in	mm	lb	kg					
Carbo Ball Bearing End Controls																				
3168	Single sheave (pair)***	1 9/16	40	4 13/16	122	2 1/4	57	27	767	3/8	10	1 7/16	36	450	204	1600	725	1:1 / 2:1		
3169	Double sheave (pair)***	1 9/16	40	4 13/16	122	2 1/4	57	31	887	3/8	10	2	51	900	408	2300	1040	3:1 / 4:1		
3170	Double sheave/150 Cam-Matic (pair)***	1 9/16	40	4 13/16	122	4 1/8	104	39	1116	3/8	10	2	51	900	408	2300	1040	3:1 / 4:1		
3197	Triple sheave/deadend (pair)	1 3/8,	2 1/4	35,	57	6 3/4	171	2 1/4	57	32.4	918	3/8	10	2 1/2	64	1500	680	2500	1134	5:1 / 6:1
High-Load End Controls																				
3173	High-load single (pair)	2 1/4	57	6 7/16	164	2 1/4	57	35	981	7/16	12	1 1/16	28	2500	1134	5000	2268	1:1 / 2:1		
3174	High-load double (pair)	2 1/4	57	6 7/16	164	2 1/4	57	41	1169	7/16	12	1 15/16	49	1650	750	3300	1500	3:1 / 4:1		
Pinstops																				
3212	Adjustable pinstop			2 9/16	65	2 1/4	57	8**	227**			1 5/16	33							
3213	Adjustable pinstop/shackle			4 7/16	113	2 1/4	57	15.2**	431**			1 27/32	46	3500	1588					
3304	Adjustable pinstop			2 1/2	64	2 1/4	57	10.3**	294**			1 3/16	30							
ESP Sleeve Bearing End Controls																				
E3230	Single sheave/deadend (pair)	1 3/8	35	4 13/16	122	1 13/16	45	19.54	554	3/8	10	1 7/16	36	1800	816	3600	1633	2:1		
E3230.HL	High-load/single sheave/deadend (pair)	1 9/16	40	4 13/16	122	1 13/16	45	23.4	642	3/8	10	1 1/2	40	2500	1134	5000	2268	2:1		
E3250HB	High-beam/double sheave (pair)*	2 1/4	57	6 1/8	155	2 1/4	57	54.6	1547	3/8	10	1	25	700	318	1400	635	3:1 / 4:1		
E3250	Double sheave/deadend (pair)	1 3/8	35	4 13/16	122	1 13/16	45	24.2	686	3/8	10	2 1/4	56	1800	816	3600	1633	3:1 / 4:1		
E3250.HL	High-load/double sheave/deadend (pair)	1 9/16	40	4 13/16	122	1 13/16	45	27.8	788	3/8	10	2 1/2	64	2500	1134	5000	2268	3:1 / 4:1		
E3256	Double sheave/deadend/150 Cam-Matic (pair)‡	1 3/8	35	3 3/4	95	4 1/8	104	45.08	1278	3/8	10	2 1/4	56	900	408	2300	1040	4:1		

*Requires high-beam track. **Weight each. ***Includes 10 mm RH fasteners.

‡Maximum working loads and breaking loads based on cam strengths.

32 mm Big Boat: Car Accessories



Traveler kit installation



Stand-Up Toggles

Stand-up toggles hold blocks upright on travelers. Control tangs allow attachment of ball bearing Carbo control blocks.

Refer to chart below for mainsheet block compatibility. See page 110 for control block purchase selection guide.

Couplers

Big Boat couplers join two cars to form high-load assemblies. The high-load 580 and 752 couplers fit T3201B and T3201B.HL cars. Use 580 and 752 couplers for single-point attachments. Use single, double, or triple Black Magic with the 752 coupler.

Control Block Kits

Kits are available for Big Boat cars to add ESP sleeve-bearing control systems for up to 6:1 purchases. Combine with ESP end controls.

Replacement Traveler Kit

Replacement traveler kits are the easiest way to restore modern traveler function. Kit comes with prematched parts for easy retrofits.



3225



1947



3190



1948



1949



Control blocks attach to ears to reduce load on car.



Toggles have a low pivot point to handle mainsheet loads up to 40 degrees from vertical, while allowing cars to roll freely.



T32KIT
T32KIT.HL

Replacement Traveler Kit

Part No.	Description	Boat length				Max mainsail area				Maximum working load		Purchase	Includes
		Mid-boom ft	Mid-boom m	End-boom ft	End-boom m	Mid-boom ft ²	Mid-boom m ²	End-boom ft ²	End-boom m ²	lb	kg		
3190	32 mm traveler kit/4:1	31 - 40	9.5 - 12.2	35 - 44	10.7 - 13.4	350	32.5	425	39.5	3000	1361	4:1	(1) T3241B, (1 pair) E3256

Stand-Up Toggles

Part No.	Description	Mainsheet block pin Ø		Control block pin Ø		Height		Maximum working load		Accepts mainsheet blocks
		in	mm	in	mm	in	mm	lb	kg	
1947	Stand-up toggle	5/16, 3/8	8, 10			2 15/32	63	7500	3401	60 mm Element doubles, triples; 80 mm Element singles; Midrange blocks; 57 mm double, triple Black Magic; 75 mm single, double Black Magic; 100 mm single Black Magic
1948	Stand-up toggle/control tangs	5/16, 3/8	8, 10	1/4	6	2 3/4	70	7500	3401	
1949	Stand-up toggle/1 control tang	5/16, 3/8	8, 10	1/4	6	2 3/4	70	7500	3401	

Couplers & Control Block Kits

Part No.	Description	Sheave Ø		Length		Width		Weight		Max line Ø		Maximum working load		Breaking load	
		in	mm	in	mm	in	mm	oz	g	in	mm	lb	kg	lb	kg
3225	2-sheave control block*	2 1/4	57	5 3/8	143			8.8	249	1/2	12	2500	1134	5000	2268
T32KIT	Purchase upgrade kit**	(4) 35 mm control blocks, (2) Midrange/Big Boat deadends, (8) M6 fasteners													
T32KIT.HL	Purchase upgrade kit/high-load‡	(4) 40 mm control blocks, (2) Big Boat deadends, (8) M8 fasteners													

*Fits T32x4B.HL cars. **Fits 35 mm sheave Ø. ‡ Fits 40 mm sheave Ø.

32 mm Big Boat: Purchase Selection Guide



TSS, 15.24 m (50'), Marsaudon Composites, naval architect: Christophe Barreau © Gérald Bibot

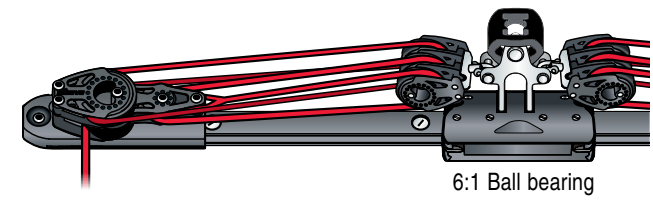
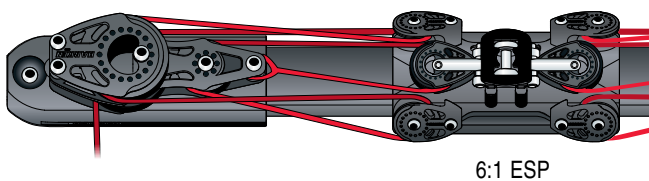
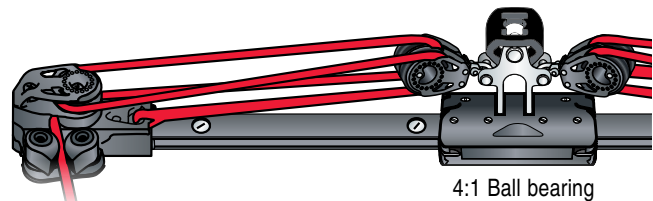
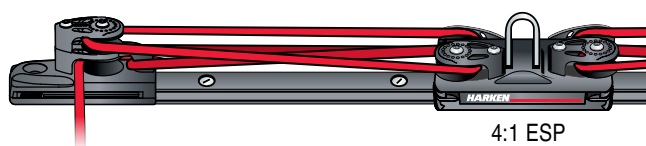
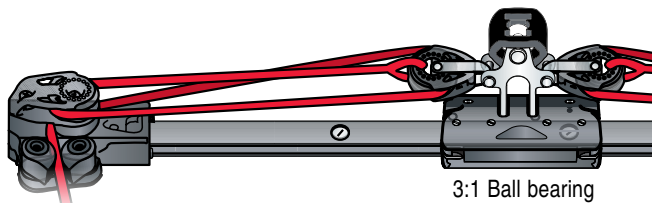
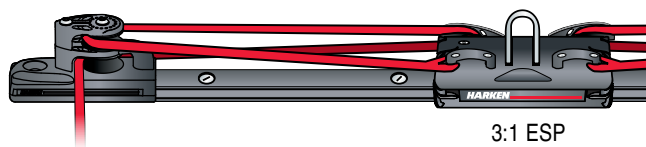
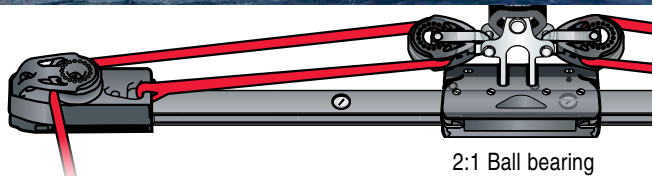
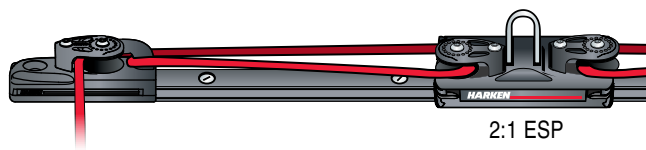

Purchase	Car	End control	Control block on car
2:1 ball bearing	T3201B	3168	1948 with 2600
2:1 ESP	T3201B	E3230	T32KIT
3:1 ball bearing	T3201B	3169, 3170	1948 with 2601
3:1 ESP	T3201B	E3250, E3256	T32KIT
4:1 ball bearing	T3201B	3169, 3170	1948 with 2642
4:1 ESP	T3201B	E3250, E3256	T32KIT
6:1 ball bearing	T3201B	3197	1948 with 2640
6:1 ESP	T3201B	3197	T32KIT & 1948 with 2650



32 mm Big Boat: Genoa Lead Cars

CB adjustable genoa lead cars feature recirculating Torton® ball bearings for easy adjustment under full sheet loads.

Stainless steel sheave carriers pivot 60 degrees to accommodate changing lead angles. Wide sheave holds two sheets during sail changes.

Cars feature car-mounted, sleeve-bearing control blocks for strength and durability. All CB genoa lead cars are compatible with Harken end controls. Kits are available for purchase upgrades up to 4:1.

CB Adjustable Cars

Sheave carriers feature high-performance sheaves with roller bearings to handle radial loads, while sideload balls handle thrust loads for easy trimming and fore-and-aft adjustment.

ESP CB Adjustable & Pinstop Cars

Sheave carriers feature ESP sleeve bearing sheaves.

Use pinstop cars in applications where lead positions change infrequently.

Pinstop and ball bearing genoa lead cars both run on ball bearing track, allowing system upgrades without changing track.

Torton is a registered trademark of Solvay Advanced Polymers L.L.C.



CB ADJUSTABLE



ESP CB ADJUSTABLE



PINSTOP



CUSTOM

For sheet-loading formulas see page 279.

End control selection guide

Purchase	Car	End control
3:1	G323B/G3237B	E3250.HL/3174
4:1	G324B/G3247B	E3250.HL/3174

Part No.	Description	Sheave Ø		Length		Width		Weight		Maximum working load		Breaking load		Track
		in	mm	in	mm	in	mm	oz	g	lb	kg	lb	kg	
CB Adjustable														
G321B.HL	Big Boat/puller	3	76	10 5/8	270	3 3/8	85	83.95	2380	7716	3500	15432	7000	R32
G3237B	Big Boat/sheave/deadend	3	76	9 1/16	231	3 3/8	85	63.27	1794	5000	2268	10000	4536	R32
G3247B*	Big Boat/2 sheave	3	76	9 1/16	231	3 3/8	85	65.12	1846	5000	2268	10000	4536	R32
ESP CB Adjustable														
G322B.HL	Big Boat/sheave	3	76	10 5/8	270	3 3/8	85	85.43	2422	7716	3500	15432	7000	R32
G323B	Big Boat/sheave/deadend	3	76	9 1/16	231	3 3/8	85	59.54	1688	5000	2268	10000	4536	R32
G324B	Big Boat/2 sheaves	3	76	9 1/16	231	3 3/8	85	62.14	1761	5000	2268	10000	4536	R32
ESP Pinstop														
G326S	Big Boat/pinstop	3	76	9 1/8	232	2 1/2	64	53.26	1510	5000	2268	10000	4536	R32
G326S.HL	Big Boat HL/pinstop	3	76	9 1/8	232	2 1/2	64	62	1758	6000	2722	12000	5443	R32
Custom														
C6795	Big Boat/pinstop†	3	76	10	254	2 1/4	57	61.83	1753	7716	3500	15432	7000	R32
C10051	Big Boat genoa lead**‡	2 15/16	75	10	254	2 3/8	60	59.26	1680	13228	6000	26448	12000	R32
C10232	Big Boat/pinstop**‡	2 15/16	75	10	254	2 3/8	60	61	1738	13228	6000	26448	12000	R32

*Available as a non-CB car on a car loader to run on a non-CB style track supplied before 2004. Add .NW to end of part number. See page 275 for replacement balls.

**50 mm hole spacing required. †Contact Harken to request quote and lead time.



CB Cars: Windward Sheeting & 3:1 Cars with Cams

Windward Sheeting Cars

Race once with the windward sheeting traveler car and you'll never race without one again. Pull the car above the centerline without releasing the leeward control line. Tack, and the car stays in the same position, ready to be pulled to the new windward side.

Mount track in the cockpit or near deck level.
For dinghies to large offshore boats.

3:1 Midrange Cars with Cams

The 1628 and 1629 cars with 365 Carbo-Cam cleats provide additional mechanical advantage (3:1 versus 2:1) by trimming from the car as opposed to a fixed point at the end of the track. Cars fit 27 mm Midrange CB track.



2745



2746



1635
1636



3176
3178



3177
3179

WINDWARD SHEETING CARS



Wire retaining clips keep balls captive, making cars easy to load and maintain. Composite corner keepers help keep ball bearings captive when the car is off the track. For a cost-effective option, CB+ cars can be modified to run on Harken non-CB track.



1628
1629

3:1 MIDRANGE
CARS WITH CAMS*



2752



1637



3180

WINDWARD SHEETING ADAPTER KITS

Windward Sheeting Adapter Kits

Part No.	Description	Max line Ø		Fits cars	Purchase
		in	mm		
1637	Midrange CB	3/8	10	1624 / 1625	3:1 / 4:1
2752	Small Boat CB	5/16	8	2726 / 2727 / 2728 2729 / 2730 / 2731 / 2735 / 2736 / 2753 / 2754	2:1 / 3:1
3180	Big Boat CB	3/8	10	3163 / 3165	4:1 / 5:1 / 6:1

Part No.	Description	Length		Width		Weight		Max line Ø		Maximum working load		Breaking load		Purchase/end controls
		in	mm	in	mm	oz	g	in	mm	lb	kg	lb	kg	
22 mm Small Boat Windward Sheeting														
2745	Small Boat CB	6 7/8	175	3 1/16	78	24.75	702	5/16	8	850	386	2500	1134	2:1 / 3:1 / 2740
2746	Small Boat CB/high-load	6 7/8	175	3 1/16	78	26	737	5/16	8	1250	567	2500	1134	2:1 / 3:1 / 2740
27 mm Midrange 3:1 Cars with Cams														
1628	Midrange CB/365 Carbo-Cam*	9 1/8	232	4 3/8	111	25.76	730	3/8	10	1800	816	5000	2268	3:1 / 1631
1629	Midrange CB/high-load/365 Carbo-Cam*	9 1/8	232	4 3/8	111	27.2	771	3/8	10	2300	1043	5000	2268	3:1 / 1631
27 mm Midrange Windward Sheeting														
1635	Midrange CB	6 3/4	171	4 1/8	105	35	990	3/8	10	1800	816	5000	2268	3:1 / 4:1 / 1631
1636	Midrange CB/high-load	6 3/4	171	4 1/8	105	36	1020	3/8	10	2300	1043	5000	2268	3:1 / 4:1 / 1631
32 mm Big Boat Windward Sheeting														
3176	Big Boat CB	9 9/16	243	5	127	57	1618	3/8	10	3000	1361	7000	3175	4:1 / 3168, 5:1 / 6:1 / 3169
3177	Big Boat CB/stand-up	9 9/16	243	5	127	62	1747	3/8	10	3000	1361	7000	3175	4:1 / 3168, 5:1 / 6:1 / 3169
3178	Big Boat CB/high-load	9 9/16	243	5	127	61	1723	3/8	10	4500	2041	9000	4081	4:1 / 3168, 5:1 / 6:1 / 3169
3179	Big Boat CB/high-load/stand-up	9 9/16	243	5	127	65	1851	3/8	10	4500	2041	9000	4081	4:1 / 3168, 5:1 / 6:1 / 3169

See page 275 for replacement balls. *Not windward sheeting. Stop knot required to keep car from hitting end control.

42 mm Mini-Maxi

Mainsail Traveler Cars

42 mm Mini-Maxi travelers bring the ease of dinghy traveler adjustment to large offshore boats. Cars ride on two rows of recirculating Torton® ball bearings and roll freely under high, nonvertical loads. Custom configurations or cars for horizontally curved track available on request.

Genoa Lead Cars

All cars are available with a plain body, with pinstops, or puller tangs. Car bodies are made of either hardcoat-anodized aluminum or high-luster stainless steel. Maximum working loads range from 4082 kg (9000 lb) to 9000 kg (19842 lb). Custom cars can be designed to handle higher loads.

Torton is a registered trademark of Solvay Advanced Polymers L.L.C.



ENDSTOPS



GENOA LEAD CARS



MAINSAIL TRAVELER CARS

Mainsail Travelers

Part No.	Description	Length		Width		Height		Weight		Maximum working load		Breaking load		Track
		in	mm	in	mm	in	mm	oz	g	lb	kg	lb	kg	
C13849	Traveler car/soft attach	16	406	4 1/3	110	3 1/4	83	116.4	3300	15432	7000	30865	14000	1706
C12369	Traveler car with 2 Black Magic 125mm	16	406	4 1/3	110	11	281	194	5500	15432	7000	30865	14000	1706
1702	Endstop*	3 3/4	95	2 5/8	67	1 1/2	38	13	369					1706
1708	Adjustable stop	3 1/2	89	2 5/8	67	2 1/16	52	15	425					1706
1707	End control/padeye	5 1/4	133	2 5/8	67	3 1/8	79	29	822	7800	3540	15594	7075	1706
3069	End control/footblock/becket	5 5/8	143	2 5/8	67	2 3/4	70	25	710	2500	1134	5000	2268	1706
C5280	Traveler/(2) 3261 blocks‡	16	406	4 3/8	111	11	278	221	6275	12500	5670	25000	11340	1706
C5231	Traveler/(2) 3254 blocks‡	16	406	4 3/8	111	10	243	192	5443	10600	4808	21200	9616	1706
3068	Traveler**	10	254	4 3/8	111	3 3/4	95	81	2300	8750	3969	18000	8164	1706
HC10066	Traveler/HCP1128 toggle	10	254	4 3/8	111	4 3/16	106	91	2574	8750	3969	18000	8164	1706
C6138	End control with Black Magic 75mm w/becket	6	153	2 1/2	66	2 1/3	58	34.57	980	5258	2385	10516	4770	1706
C7513	Endstop/627 padeye‡	3 13/16	97	2 5/8	67	2 11/16	68	19	528	4300	1950	8600	3900	1706
C12792	Pinstop car	2 15/16	74	2 1/8	56	1 1/8	29	6.5	185	6614	3000	13228	6000	1706
C6762	Self-Tacking car with 2 Black Magic 125mm	16	406	4 1/3	110	11	282	238	6750	15432	7000	30864	14000	1706
C14967	Self-Tacking car	16	406	4 1/3	110	9 3/8	239	174.25	4940	10582	4800	21164	9600	1706
C15190	Self-Tacking car	12	305	4 1/3	110	11 3/8	290	139.33	3950	11001	4990	22002	9980	1706

*12 mm (1/2") FH fasteners. **See page 272 for replacement balls. ‡Contact Harken to request quote and lead time.

Genoa Lead Cars

Part No.	Description	Sheave Ø		Length		Width		Height		Weight		Maximum working load		Breaking load		Track
		in	mm	in	mm	in	mm	in	mm	oz	g	lb	kg	lb	kg	
C15012	Mini-Maxi Jib Car — adjustable	4	100	14	356	2 15/16	75	7 7/16	189	134.4	3810	19841	9000	39683	18000	1706
C10434	Mini-Maxi Jib Car — adjustable	3	75	10	254	2 15/16	75	6	155	73.4	2080	13228	6000	26455	12000	1706
C5900	Mini-Maxi lead car/slider rods	5 1/2	140	12	305	2 15/16	75	9 3/16	233	208.11	5900	14994	6800	39242	17800	1706

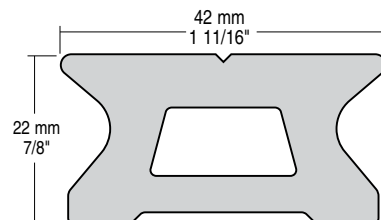

Track

Part No.	Length	Mounting hole spacing*		Weight		Fasteners (FH)			
		ft/in	m	in	mm	oz	kg	in	mm
1706.1.5M	4' 11 1/16"	1.5	2 15/16	75	81.5	2.31	3/8	10	1702
1706.3M	9' 10 1/8"	3	2 15/16	75	163	4.62	3/8	10	1702
1706.3.6M	11' 9 3/4"	3.6	2 15/16	75	195.4	5.54	3/8	10	1702

*First hole 37.5 mm (1 1/2"). Contact Harken to request quote and lead time for custom length.

Track bending			
Minimum track radius			
Horizontal		Vertical	
Track	ft	m	ft
1706	50	15.25	50

64 mm Maxi

Mainsail Traveler Cars

64 mm Maxi travelers bring the ease of dinghy traveler adjustment to large offshore boats. Cars ride on two rows of recirculating Torton® ball bearings and roll freely under high, non-vertical loads. Custom configurations or cars for horizontally curved track available on request.

Genoa Lead Cars

All cars are available with a plain body, with pinstops, or puller tangs. Car bodies are made of either Hard Lube-anodized aluminum or high-luster stainless steel. Maximum working loads range from 9000 kg (19841 lb) to 13000 kg (28660 lb). Custom cars can be designed to handle higher loads.



Torton is a registered trademark of Solvay Advanced Polymers L.L.C.



ENDSTOPS



GENOA LEAD CARS



MAINSAIL TRAVELER CARS

Mainsail Travelers

Part No.	Description	Sheave Ø		Length		Width		Height		Weight		Maximum working load		Breaking load		Track
		in	mm	in	mm	in	mm	in	mm	oz	g	lb	kg	lb	kg	
C5160	Double pinstop**			5 1/4	133	3 3/4	95	2 9/16	65	38	1077	1900	8618	38000	17232	Custom
C6361	Endstop w/689 padeye**			4 11/16	119	3 3/4	95	3 1/2	89	37	1048	7800	3540	15600	7075	661
662	Endstop*			4 3/4	121	3 3/4	95	2	51	28.8	816					661
664	Adjustable stop			3 7/8	98	3 3/4	95	2 1/2	64	26	737					661
3071	End control/footblock/becket	2 15/16	75	7 1/8	181	3 3/4	95	3 3/8	86	56	1596	5250	2380	10500	4762	661
C8583	Traveler**‡	5 15/16	150	28 1/4	718	5 3/16	132	12 7/8	327	537.6	15241	21168	9600	42336	19200	661
C14949	Traveler car with MYB **	6	150	14	356	3 3/4	95	12	309	224	6350	22046	10000	44092	20000	661

*16 mm (5/8") FH fasteners. ‡When used in 4:1 system MWL is 13608 kg/30000 lb. **Contact Harken to request quote and lead time.

Genoa Lead Cars

Part No.	Description	Sheave Ø		Length		Width		Height		Weight		Maximum working load		Breaking load		Track
		in	mm	in	mm	in	mm	in	mm	oz	g	lb	kg	lb	kg	
C15086	Maxi Jib Car- adjustable	6 7/8	175	14	356	3 11/16	93	12 11/16	322	268	7610	28660	13000	57320	26000	661
C9368	Slider/dual pinstop	5 15/16	150	12	305	3 9/16	91	12 1/4	311	205.6	5829	19841	9000	39683	18000	Custom

Contact Harken to request quote and lead time.

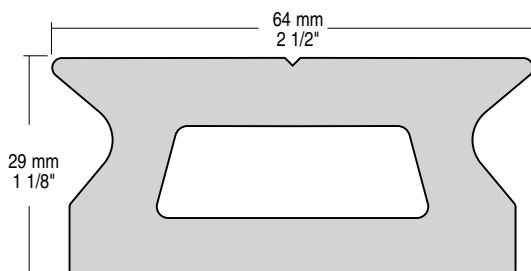

Track bending				
Minimum track radius				
Track	Horizontal		Vertical	
	ft	m	ft	m
661	100	30.5	50	15.25

Track

Part No.	Length		Mounting hole spacing*		Weight		Fasteners (FH)		
	ft/in	m	in	mm	oz	kg	in	mm	Endstop
661.2.1M	6' 10 11/16"	2.1	3 15/16	100	221.5	6.28	1/2	12	662
661.3M	9' 10 1/8"	3	3 15/16	100	316.4	8.97	1/2	12	662

*First hole 50 mm (1 15/16").
Contact Harken to request quote and lead time for custom length.

CRX Roller Cars

The Harken Custom Division has been supplying racers and cruisers with innovative hardware for over 20 years. Whether you use existing custom solutions or require something new, our engineers hold your project to the highest standards: from design, to manufacturing, finishing, installation, and worldwide service.

CRX Cars

CRX Roller traveler cars carry almost double the load at half the weight of similarly sized traveler cars. Torlon® rollers provide increased bearing contact over balls to handle higher loads. Captive bearings make cars easy to load and maintain.

Toggle cars such as the 3074 and 3075 offer a low-profile traveler solution. CRX Loop cars are alternatives for high-load applications.

Use roller travelers with straight track only. Contact Harken for curved traveler applications. Big Boat CRX track uses E3200 endstops and 3173 or 3174 end controls. Mini-Maxi track uses 1702 or custom endstops.

Torlon is a registered trademark of Solvay Advanced Polymers L.L.C.



32 MM BIG BOAT



42 MM MINI-MAXI

CRX Roller Cars

© Sharon Green | UltimateSailing.com



C12728 C11349



Low-profile endstops available for CRX roller systems. Contact Harken.



MEGA

Part No.	Description	Length		Width		Height		Weight		Maximum working load		Breaking load		Track
		in	mm	in	mm	in	mm	oz	g	lb	kg	lb	kg	
32 mm Big Boat CRX														
3074	CRX Big Boat/single block	5	127	2 1/2	64	3 3/8	86	22	624	5000	2268	10000	4535	3079
3075	CRX Big Boat/single block†	7 1/2	191	2 1/2	64	3 3/8	86	39	1106	7500	3401	15000	6803	3079
C8914	Endstop low profile *	2	50	1 1/4	32	7/16	11	6.7	190	1653	750			3079
C8728	CRX Big Boat Loop car	3 3/8	86	2 1/2	64	2	50	11.6	330	3300	1500	6600	3000	3079
C9969	CRX Big Boat Loop car	4 1/8	105	2 1/2	64	2	50	18	510	4188	1900	8377	3800	3079
C14640	CRX Big Boat Loop car	5	127	2 1/2	64	2	50	70.5	2000	5004	2270	10009	4540	3079
C9460	CRX Big Boat Loop car	7 1/2	191	2 1/2	64	2	50	78	2200	7483	3400	14967	6800	3079
C15258	CRX Big Boat Athwartships Jib car	8 3/8	213	2 1/2	64	5	122	71	2030	9921	4500	19842	9000	3079
C13285	Pinstop Car for 32mm CRX Track	2 7/16	62	1 3/4	43	1 1/8	29	3.17	90	2866	1300	5732	2600	3079
42 mm Mini-Maxi CRX														
C8378	Endstop low profile *	3 5/8	92	1 9/16	40	7/16	11	6	107					3200
C9701	CRX Mini-Maxi/titanium coupler/2 blocks	16 3/16	411	3 1/32	77	4 11/16	119	113.63	3222	19845	9000	39618	18000	3200
C10747	CRX Mini-Maxi/aluminum coupler/2 blocks	15 1/8	384	3 1/32	77	5 9/16	141	96.06	2723	14307	6500	28613	13000	3200
C8955	CRX Mini-Maxi Loop car	7 1/2	191	3 1/32	77	2 1/4	57	29.2	827	7937	3600	15874	7200	3200
C9642	CRX Mini-Maxi Loop car	8	203	3 1/32	77	2 5/8	67	34.39	975	9921	4500	19845	9000	3200
C10413	CRX Mini-Maxi Loop car	11 1/2	292	3 7/32	82	3	76	57.97	1643	14434	6558	28868	13116	3200
C10598	CRX Mini-Maxi Traveler car with coupler/2 blocks	20	514	3	77	5 3/8	137	146	4150	23589	10700	47179	21400	3200
C14943	CRX Mini-Maxi Athwartships Jib car	11 1/2	292	3	77	4 7/8	122	76	2150	14458	6558	28916	13116	3200
C11432	Pinstop Car for 42mm CRX Track	2 3/4	70	2 1/4	57	1 1/8	30	6.7	190	8377	3800	16755	7600	3200
Mega CRX														
C9541	Endstop - single*	4 1/4	108	3 3/4	95	1 7/8	47	47	1350					Custom
C6924	CRX mega/coupled	16 1/4	413	4 1/4	108	6 1/2	165	263.04	7457	26500	12020	53000	24040	Custom
C8990	CRX mega/coupled	20 1/4	515	4 1/4	108	6 1/2	165	301.59	8550	33069	15000	66138	30000	Custom
C15265	CRX Mega Traveler car with 150mm Black Magic blk	10	254	4 1/4	108	13 7/8	352	197	5590	19841	9000	39683	18000	Custom
C9679	CRX Mega Traveler car with coupler 2/MYB blocks	20 1/4	514	4 1/4	108	11 5/8	295	357	10140	30865	14000	61729	28000	Custom
C13559	CRX Mega Traveler car with coupler/1 block	20 1/4	514	4 1/4	108	8 1/8	207	327	9270	40785	18500	81571	37000	Custom
C12728	CRX Mega Athwartships Jib car	10	254	4 1/4	108	5 1/2	140	11.3	320	17637	8000	35274	16000	Custom
C11349	CRX Mega Athwartships Jib car	13 3/8	339	4 1/4	108	7 1/2	192	20	570	26455	12000	52910	24000	Custom

Contact Harken to request quote and lead time. †Includes adapter to fit 100 mm Black Magic. *Sold in pairs

CRX Track

Part No.	Length		Mounting hole spacing		Weight		Fasteners (FH)		Endstop/splice link
	ft/in	m	in	mm	oz	kg	in	mm	
32 mm Big Boat CRX Low-Beam Roller Track									
3079.2M	6' 6 3/4"	2	2 15/16	75	72.8	2.064	5/16	8	E3200/3080
3079.3M	9' 10 1/16"	3	2 15/16	75	109.2	3.096	5/16	8	E3200/3080
42 mm Mini-Maxi CRX Low-Beam Roller Track									
3200.3M*	9' 10 1/16"	3	2 15/16	75	144.1	4.08		10	

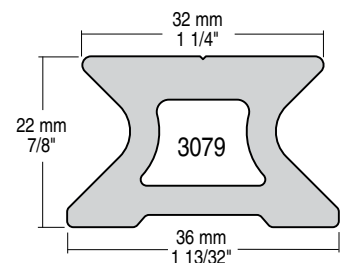

*Contact Harken for track profile.

Curved Track

Track is often bent to follow the cabin house curve or boom radius. Sometimes track is bent vertically, ends up, to relieve tension on the sail's leech as the traveler car moves off the boat's centerline.

To perform smoothly and carry the correct load, the traveler car's length must suit the track radius. Each traveler car page has a chart which shows the minimum radius on which each car will ride. If the load requires a long car, but the radius will be too tight, consider using two short cars joined by a coupler.

Minor bends can often be made when the track is installed. If the track requires more bend, Harken can provide horizontal, vertical, or compound curves to specification for a modest charge. If the bend is continuous, add 50 - 100 mm (2 - 4") to each end because track cannot be bent to its ends. Standard Harken Mini-Maxi and Maxi traveler cars cannot ride on vertical bends with a radius under 15.25 m (50').

1. Vertical Bend: Ends Down

This bend is used for mainsheet travelers mounted over the cabin house. The curve matches the crown of the cabin house and allows the track to clear the companionway hatch, but minimizes the height of the track risers.

2. Vertical Bend: Ends Up

Some boats use this bend to relieve leech tension when the traveler car moves off centerline. Ends-up bends are also used for staysails. Tracks angled forward to face the clew of the sail mount on risers.

3. Horizontal Bend

Horizontal bends allow the traveler to follow the radius of the boom as it swings across the boat. The track stays flat and the ends curve to the boat's bow or stern. Sometimes horizontal bends are used for boom vang and occasionally for staysails, especially those with booms.

4. Compound Bend

Compound bends are a combination of a vertical and horizontal bend. The track curves in the horizontal plane to follow the radius of the boom, but mounts to a deck that has a slight crown.

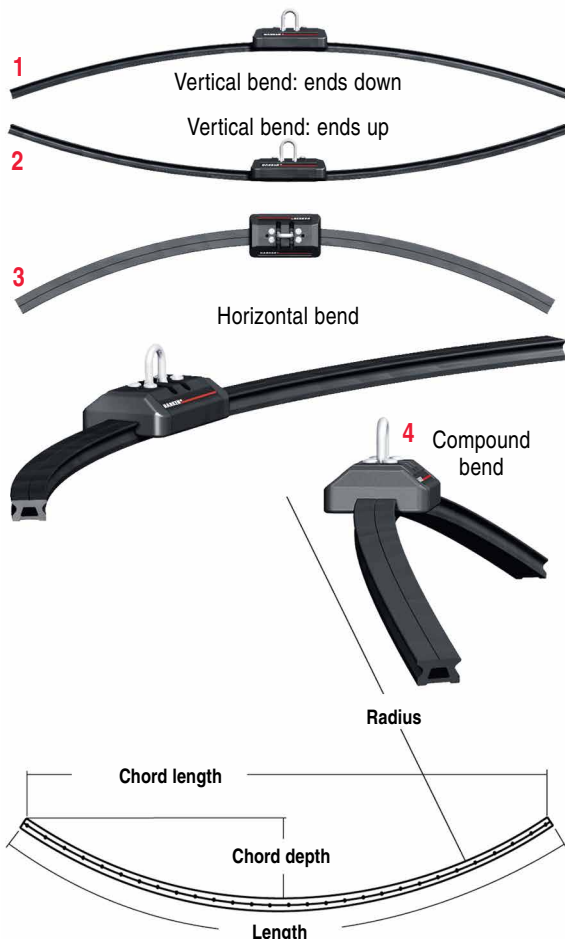

Track	Bend Part No.	Compound bends Part No.
373/374/2720/2721/2725/2751	275	286
1602/R27/ R27HB	1531	1582
R32/3159/R32HB	793	577

For 661, 1706, 2707, and 2709 track contact Harken Tech Service.

Ordering Information

To order curved traveler track, please specify the following information:

Boat model _____

Track part number _____

Bend part number _____

Chord length _____

Chord depth: horizontal _____ or radius: horizontal _____

Chord depth: vertical _____ or radius: vertical _____

Check one:

- Vertical bend: ends down
- Vertical bend: ends up
- Horizontal bend: ends forward or aft
- Compound bend:
 - horizontal and vertical (ends down)
- Compound bend:
 - Horizontal and vertical (ends up)

Harken does not cut track to length.

Aluminum & Stainless Steel T-Track

Anodized aluminum T-Track features rounded top edges for protection and impact resistance. Drilled and tapped holes at ends make endstop installation easy.

32 mm high-performance track is black hardcoat-anodized. It has precise 33 mm pinstop hole spacing.

Stainless steel track is available in 32 and 40 mm. The high-luster finish makes it ideal for luxury cruisers/racers from 9.5 m - 42 m (33 - 140').

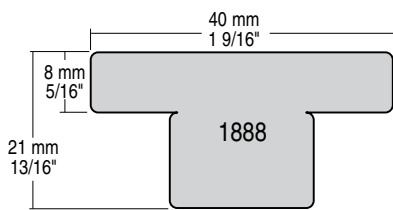
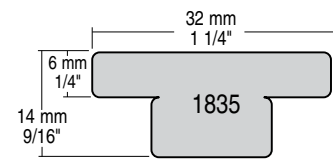
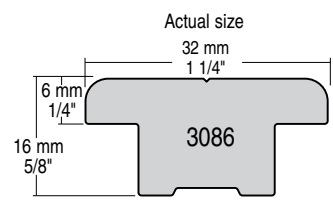

Part No.	Length		Pinstop hole spacing		Mounting hole spacing*		Weight		Fasteners (FH)		Endstop
	ft/in	m	in	mm	in	mm	oz	kg	in	mm	
32 mm Black-Anodized Aluminum T-Track											
3086.2M	6' 6 3/4"	2	3 15/16	100	3 15/16	100	63.46	1.8	5/16	8	
3086.3M	9' 10 1/8"	3	3 15/16	100	3 15/16	100	95.22	2.69	5/16	8	
32 mm Stainless Steel T-Track**											
1835.2M	6' 6 3/4"	2	1 15/16	50	3 15/16	100	169.31	4.8	5/16	8	1836
1835.4M	13' 1 1/2"	4	1 15/16	50	3 15/16	100	338.62	9.6	5/16	8	1836
40 mm Stainless Steel T-Track**											
1888.2M	6' 6 3/4"	2	1 15/16	50	3 15/16	100	282.91	8	12	12	1889
1888.4M	13' 1 1/2"	4	1 15/16	50	3 15/16	100	564.37	16	12	12	1889

50 mm T-Track available. Contact Harken to request quote and lead time. *First hole 50 mm (1 15/16").

126 **Contact Harken to request lead time.

T-Track Genoa Lead Cars

T-Track genoa lead cars are used where frequent lead adjustments are not required. T-Track cars have an integral pinstop to lock the car into position.

The car's one-piece, solid aluminum construction is lightweight and strong. The stainless steel carrier tilts side-to-side to ensure a fair lead. 40 mm cars have roller/ball bearing sheaves to improve trimming performance.

Custom accessories such as remote pinstops and adjustable sliders with tangs to accommodate floating blocks are available. Contact Harken for information on our complete range.

Note: T-Track genoa lead cars cannot be adjusted under load.



GT326S



C13260



C9043



C4219



GT256S



C5754



C10901



C9242



C10948



C8774

C5834

Skimmer, Balance 760 F, 22 m (78.12'), Du Toit Yacht Design
© Grant Scholtz / Two Oceans Marine Manufacturing



For sheet-loading formulas see page 279.

Part No.	Description	Sheave Ø		Length		Width		Height		Weight		Max line Ø		Maximum working load		Breaking load		Track	
		in	mm	in	mm	in	mm	in	mm	oz	g	in	mm	lb	kg	lb	kg		
25 mm T-Track																			
GT256S	Genoa lead car/pinstop*	2	51	4 11/16	118	2 3/8	59	4 3/8	110	16.8	475	1/2	12	2500	1134	5000	2268	25 mm***	
32 mm T-Track																			
GT326S	Genoa lead car/pinstop*	2	51	5 1/8	130	2 3/8	59	4 7/16	113	22.1	626	1/2	12	3000	1361	6000	2722	3086****	
40 mm T-Track																			
C4219	Genoa slider‡	4 1/2	114	9	229	2 9/16	65	8 7/16	214	104.6	2970	5/8	16	12860	5845	25720	11690	1888	
C9577	Jib car/pinstop‡	5 15/16	150	11	279	2 9/16	65	10 3/4	273	312	8824	1	25	15435	7000	44092	20000	1888	
C5754	Jib car/maxi sheave‡	5 1/2	140	11	279	2 9/16	65	9 1/4	235	184	5220	7/8	22	19625	8900	39249	17800	1888	
C13260	Pinstop Car for 40mm*			3 7/8	98	2 1/2	65	1 7/8	47	16	460			11023	5000	2204	10000	1888	
C9043	Pinstop Car for 40mm T-Track			4	102	2 1/2	63	2 3/8	61	59.3	1680			28660	13000	57320	26000	Custom	
50 mm T-Track‡‡																			
C10948	Jib Car with Pinstop	7 7/8	200	14	356	3 3/8	86	14	355	442	12540	1 7/16	36	33069	15000	66138	30000	Custom	
C9242	T-Track slider/puller tang‡	7 7/8	200	14	356	3 3/8	86	13 5/8	346	649	18400	1 1/8	28	50706	23000	101412	46000	Custom	
C10901	T-Track slider/puller tang*	7 7/8	200	14	356	3 3/8	86	14	356	418	11837	1 1/8	28	50706	23000	101412	46000	Custom	
C8774	Pinstop Car for 50mm T-Track			4	102	3 3/8	86	2 1/2	66	81.83	2320			28660	13000	5732	26000	Custom	
C5834	Endstop for 50mm T-Track			3 3/8	85	1 1/3	33	1 1/8	28	28	790			7015	3182	14030	6364	Custom	

*Aluminum. **Stainless steel track only. ‡Contact Harken to request quote and lead time. ††50 mm T-Track available. Contact Harken.

Access Rail System

Harken designed the Access Rail system so crews of very large yachts would have a secure system that allows freedom of movement, and the ability to lock into position while working outboard along the hull. The Access Rail system is made up of two joined cars that allow the attachment of the personal suspension and the required fall-arrest systems. Its CE certification is among the most respected marks in the world and unique in the marine industry.

Linked cars are constructed of strong, lightweight, one-piece solid aluminum. The pinstop is easy to release, and the car moves smoothly along the track before locking into another position. Wire retaining clips keep balls captive, making cars easy to load and maintain. Composite corner keepers help keep ball bearings captive when the car is off the track.

Cars and track come in black hardcoat-anodized or clear-anodized finishes for corrosion protection, durability, and to match the yacht's aesthetics. Stainless steel systems can be special ordered from Harken's Custom Division.

Use the IN10567 car when the track is mounted on a brow or angled on surfaces. The wheel toggle attachment overhangs the edge of the mounting surface so the side of the hull is not chafed.



IN9606.CLEAR



IN10567.CLEAR



IN1643.CLR



IN1650.CLR



IN9561.CLEAR



IN1642.CLEAR



IN1649
IN1651



Pinstop car allows movement of cars along track. Open to move; close to lock in place.

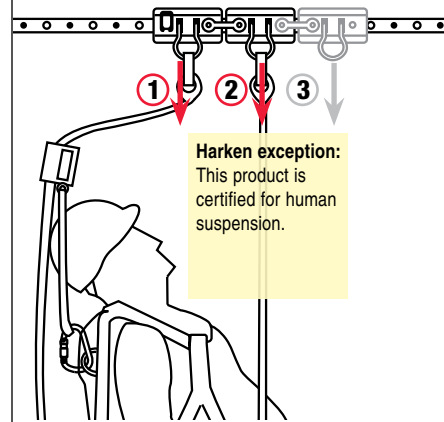

Harken exception:
This product is certified for human suspension.

The system has two anchorage points—one anchorage point for a personal suspension system and the second for the fall-arrest system. Add an optional car and coupler to work as a tool service carrier.

Harken exception: This product is certified for human suspension.

Access Rail System



Wire retaining clips keep balls captive, making cars easy to load and maintain. Composite corner keepers help keep ball bearings captive when the car is off the track. For a cost-effective option, CB+ cars can be modified to run on Harken non-CB track.



© David Servais / SD Boatworks

Car Assembly

Part No.	Description	Length		Width		Maximum working load		Fits track
		in	mm	in	mm	lb	kg	
IN9606.CLEAR*	27 mm Midrange 2-car Access Rail car assembly with coupler	10 3/4	273	2 3/4	70	300	136	IN1643, IN1650
IN10567.CLEAR*	27 mm Midrange 2-car Access Rail car assembly with wheel toggle	10 3/4	273	5 15/16	150	300	136	IN1643, IN1650

Access Rail cars must only be used with track mounted using 8 mm (5/16") fasteners. Use only endstops listed below.

*To order black hardcoat-anodized, remove ".CLEAR" from end of part number.

Removable Pinstop & Track Endstop

Part No.	Description	Length		Width		Weight		Height above track		Fasteners	
		in	mm	in	mm	oz	g	in	mm	in	mm
IN1642.CLEAR*	Pinstop	2 5/16	59	1 15/16	49	4.8	136	1 5/16	33		
IN9561.CLEAR*	27 mm Midrange track endstops (sold in pairs)	2 1/4	57	2	51	6	170	5/16	8	5/16 FH	8 FH

*To order black hardcoat-anodized, remove ".CLEAR" from end of part number.

Track

Part No.	Description	Length		Mounting hole spacing		Fasteners		Endstop	Splice link**
		ft/in	m	in	mm	in	mm		
IN1643.3M.CLR*	27 mm Midrange pinstop track for countersink fasteners	9' 10 1/16"	3	3 15/16	100	5/16 FH	8 FH	IN9561.CLEAR*	IN1649
IN1643.3.6M.CLR*	27 mm Midrange pinstop track for countersink fasteners	11' 9 3/4"	3.6	3 15/16	100	5/16 FH	8 FH	IN9561.CLEAR*	IN1649
IN1643.6M.CLR*	27 mm Midrange pinstop track for countersink fasteners	19' 8 1/4"	6	3 15/16	100	5/16 FH	8 FH	IN9561.CLEAR*	IN1649
IN1650.3M.CLR*	27 mm pinstop track for caphead fasteners	9' 10 1/16"	3	3 15/16	100	5/16 SHCS	8 SHCS	IN9561.CLEAR*	IN1651
IN1650.3.6M.CLR*	27 mm pinstop track for caphead fasteners	11' 9 3/4"	3.6	3 15/16	100	5/16 SHCS	8 SHCS	IN9561.CLEAR*	IN1651

*To order black hardcoat-anodized, remove ".CLR" or ".CLEAR" from end of part number.

**Purchase one splice link for each track section.

Harken exception: This product is certified for human suspension.





MAINSAIL

HANDLING SYSTEMS

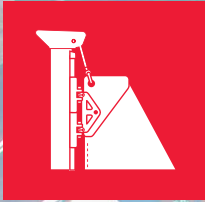

Derek M. Baylis, Wylie 65, 19.8 m (65'), Wyliecat Performance Yachts © Erik Simonson

CB & SLIDER BATTCAR SYSTEMS

Favored by skippers and crew, Harken Battcar systems let you raise, douse, and reef the main instantly from the cockpit, even when close reaching in a big breeze. Battcar systems outperform in-mast or in-boom furling, cost far less, and sails don't need to be recut. Four sizes fit monohulls to 27 m (90'); multihulls to 21 m (70').

Strong, corrosion-resistant cars and track stand up to sun, salt, and time

- One-piece, 6061-T6 aluminum cars
Hard Lube-anodized, UV-stabilized.
- Track is 6061-T6 aluminum, hardcoat-anodized.

Low-friction ball bearing cars for easy adjustment under load

- High-strength Torlon® ball bearings circulate smoothly for fast sail hoists, douses, and reefs.
- Batten toggle moves freely in all directions to prevent sail from binding when reefing under load.

Sails can be raised/lowered without sticking in mast groove

- Slider cars ride on low-friction plastic inserts.

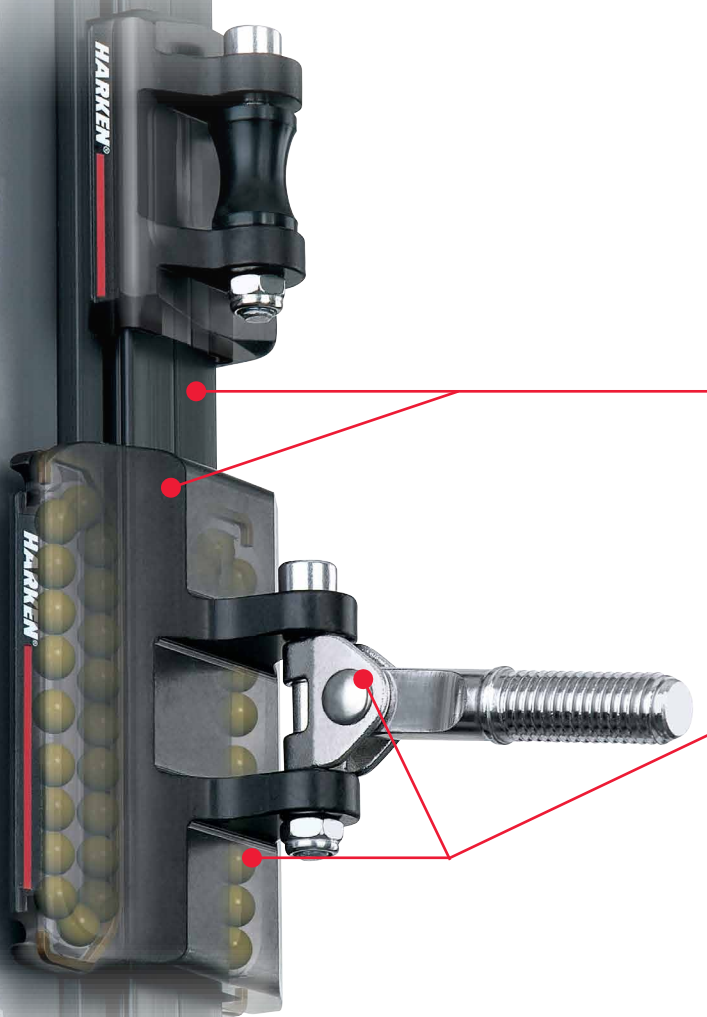

Materials
For properties
see pages
253-254.



6061-T6 aluminum:
Hard Lube-anodized cars; hardcoat-anodized track



Torlon® thermoplastic:
Ball bearings





Quick-release button



Quick sail removal

- Cars and sails slide off the track by removing the screwpin endstop—no tools required.
- CB captive bearings allow cars to easily roll off track for cleaning and maintenance.
- Captive pin features a quick-release button to remove sail quickly, while allowing car to remain on mast.

Cost-effective retrofit options

- CB and slider Battcar systems use the same track; mix and match to optimize performance and budget.
- CB+ cars can be modified to run on Harken old-style, non-CB track produced until 2003; upgrade cars without replacing track. Look for the “+” symbol at the end of the car.



Mounting kit



Screwpin endstop kit



Flanged track



Drill-and-tap track

Easy mast-up installation

- Battcar track screws directly into slugs that slide into mast groove—no drilling or tapping.

Variety of mounting options

- Slugs for flat or round mast grooves; 1 kit per track section.
- Screwpin endstops to remove cars and mainsail; 1 kit per system.
- Mount flanged track to carbon spars; track features groove for racing sails with boltropes or slugs.
- Masts without internal track, attach Harken 13 - 32 mm traveler track by drilling and tapping the spar.

System AA

Typical boat size:

Monohulls: length to 11.3 m (37');
mainsail area under 32 m² (350 ft²)

Multihulls: length to 9.1 m (30');
mainsail area under 26 m² (275 ft²)

About CB and slider Battcar systems: see feature pages at beginning of this section.



3813



Jeanneau Sun Odyssey 349, 10.34 m (33'11"), Marc Lombard design © Billy Black / Jeanneau

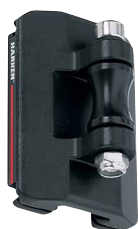

3815



3814



3816



Wire retaining clips keep balls captive, making cars easy to load and maintain.



Threaded stud and toggle design handles twisting and angled loads for quick hoisting and dousing.



Cars are easily removed from the track by freeing the screwpin endstop and sliding them off.

Part No.	Description	Length		Width		Weight		Max headboard thickness		Maximum working load	
		in	mm	in	mm	oz	g	in	mm	lb	kg
Typical Boat Length: monohulls to 11.3 m (37'); multihulls to 9.1 m (30')											
3813	CB headboard car assembly	5 3/16	132	1 9/16	40	6.7	188	1/2	12	440	200
3814	Slider intermediate car	1 3/4	44	1	25	0.5	15			130	59
3815	CB intermediate car	2 3/16	56	1 9/16	40	1.7	48			130	59
3816	CB Battcar/10 mm stud*	2 3/16	56	1 9/16	40	3	85			220	100

See page 275 for replacement balls. *Batten receptacle not included.

System AA

About CB and slider Battcar systems: See feature pages at beginning of this section.

Mast Track: Slug Mount

3817 track mounts to mast using a unique slug system that allows mast-up installation.

Mainsail luff length		Number of 3817 track sections
ft*	m*	
19'7" - 26'3"	5.98 - 8.00	4
26'4" - 33'	8.03 - 10.06	5
33'1" - 39'9"	10.08 - 12.11	6
39'10" - 46'5"	12.13 - 14.16	7

*Track extends above sail luff. Using screwpin endstop kits will increase lengths.

Part No.	Description	Length		Weight		Fastener spacing		Fastening method
		in	m	oz/ft	g/m	in	mm	
3817	Slug-mount track	80 3/4	2.05	2.84	264	3 15/16	100	Mounting slugs

Traveler Track: Drill/Tap

For masts without internal sail track, attach 2707 Micro traveler track by drilling and tapping the spar. Join track sections with splice links. Order one per track joint. Order one low-beam endstop (sold in pairs).

Part No.	Description	Splice link	Endstop	Ordering information	Fastening method



Kazahaya, Parigi 30, Alessandro Comuzzi architect © Alessandro Comuzzi



3817 Slug-mount track



3818 Mounting kit
3821 Endstop kit/screwpin



3819 Mounting kit
3822 Endstop kit/screwpin

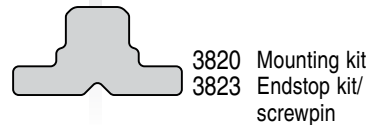

3820 Mounting kit
3823 Endstop kit/screwpin

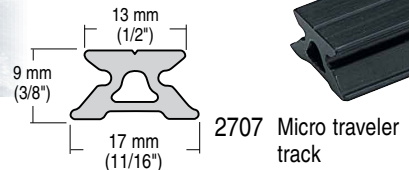

2707 Micro traveler track

Mounting Kits and Endstops

Mounting kit slugs are available for flat or round mast grooves. Order one kit per track section.

Use screwpin endstop to easily remove cars and mainsail. Order one kit.

MOUNTING KIT



3818
3819
3820

MICRO TRACK ENDSTOP KIT/SCREWPIN



3837

ENDSTOP KIT/SCREWPIN



3821
3822
3823

Track Mounting Kits: Slug Mount*

Part No.	Description	Mounting slug				Mounting slugs/kit	Connector slug				Fits flat mast groove gap						
		Length in	Length mm	Weight oz	Weight g		Length in	Length mm	Weight oz	Weight g	Connector slugs/kit	Min in	Min mm	Max in	Max mm		
3818	Round mast groove	3/4	19	0.14	4	19	2 5/8	67	0.54	15	1						
3819	Flat mast groove	3/4	19	0.17	5	19	2 5/8	67	0.6	17	1	5/16	8	7/16	11		
3820	Wide flat mast groove	3/4	19	0.25	6	19	2 5/8	67	0.94	23	1	7/16	11	1/2	13		

Endstop Kits: Slug Mount & Drill/Tap*

Part No.	Description	Track end length		Weight		Mounting slugs/kit
		in	mm	oz	g	
3821	Round mast groove/screwpin	6	152	2.4	70	2
3822	Flat mast groove/screwpin	6	152	2.4	70	2
3823	Wide flat mast groove/screwpin	6	152	2.4	70	2
3837	Micro track/screwpin	6	152	2.2	62	

*Includes M4 x .7 x 20 or 25 mm fasteners.

System A Battcars

Typical boat size:

Monohulls: length 11.3 - 15.2 m (37 - 50');
mainsail area under 56 m² (600 ft²)

Multihulls: length 9.1 - 12.2 m (30 - 40');
mainsail area under 46 m² (500 ft²)

About CB and slider Battcar systems:
see feature pages at beginning of this section.



Designed to work with battent receptacles from New Zealand's C-Tech Sailbattens, the pintles have shoulders that protect the threads from bending.



CB BALL BEARING CARS



SLIDER CARS

Part No.	Description	Length		Width		Weight		Max headboard thickness		Max battent Width		Ø	Batten	Maximum working load		
		in	mm	in	mm	oz	g	in	mm	in	mm			lb	kg	
CB Cars: Typical Boat Length: Monohulls 11.3 - 15.2 m (37 - 50'); Multihulls 9.1 - 12.2 m (30 - 40)*																
3811*	Headboard car assembly	8 3/8	213	2 1/4	57	18	518	9/16	14					1600	725	
3889	Headboard car assembly/quick-release	9 1/2	240	2 1/4	57	21.5	610	9/16	14					1600	725	
3812*	Intermediate car**	2 1/4	57	2 1/4	57	4	109							465	211	
3829*	Battcar/10 mm stud**	2 7/8	73	2 1/4	57	6	157							600	272	
3830*	Battcar/40 mm receptacle	2 7/8	73	2 1/4	57	9	253			1 5/8	41	5/8	16	Flat/Round	600	272
3881	Battcar/12 mm stud**	2 7/8	73	2 1/4	57	6.4	182							600	272	
3831*	Universal Battcar**	2 7/8	73	2 1/4	57	4.3	122							600	272	
3882	Long battent car/12 mm stud**	4 1/8	105	2 1/4	57	8.2	232							875	397	
3883	Reef car	4 1/8	105	2 1/4	57	6.1	174							875	397	
3901	Battcar/10 mm stud for C-Tech Battent	2 7/8	73	2 1/4	57	6	157							600	272	
3908	Battcar/12 mm stud for C-Tech Battent	2 7/8	73	2 1/4	57	6.4	182							600	272	
3909	Long battent car/12 mm stud for C-Tech Battent	4 1/8	105	2 1/4	57	8.2	232							875	397	
Slider Cars: Typical Boat Length: Monohulls 11.3 - 15.2 m (37 - 50'); Multihulls 9.1 - 12.2 m (30 - 40)*																
3827	Headboard car assembly**	6	153	1 3/8	35	10	269	9/16	14					1600	725	
1777	Low-load intermediate car‡	2	51	1 1/4	32	1.1	32							200	91	
3828	Intermediate car	1 3/4	44	1 3/8	35	1.6	45							159	350	
3802	Battcar/10 mm stud**	1 3/4	44	1 3/8	35	2.8	80							350	159	
3803	Battcar/40 mm receptacle	1 3/4	44	1 3/8	35	6.38	181			1 5/8	41	5/8	16	Flat/Round	350	159
3902	Battcar/10 mm stud for C-Tech Battent	1 3/4	44	1 3/8	35	2.8	80							350	159	
C14840	Intermediate car/quick-release pin	1 3/4	44	1 3/8	35	1.2	37							200	91	

See page 275 for replacement balls. *Available as a non-CB car on a car loader to run on a non-CB style track supplied before 2003. Add .NW to end of part number.

‡ Max. sail area: Monohull 33 m² (350 ft²), Multihull 28 m² (300 ft²). **Battent receptacle not included.

System A

About CB and slider Battcar systems: See feature pages at beginning of this section.

Mast Track

3807 track mounts to mast using a unique slug system that allows mast-up installation.

Use flanged track when mounting to carbon spars. Track features a groove for racing sails with boltropes or slugs.

Part No.	Description	Length		Weight		Fastener spacing		Fastening method
		in	m	oz/ft	g/m	in	mm	
3807	Slug-mount track	80 3/4	2.05	4.44	413	4 15/16	125	Mounting slugs
3878.2M	Flanged track	78 3/4	2	6.7	626			Adhesive
3878.6M	Flanged track	236 1/4	6	6.7	626			Adhesive

Traveler Track: Drill/Tap

For masts without internal sail track, attach 2720 Small Boat traveler track by drilling and tapping the spar. Join track sections with splice links. Order one per track section. Order one low-beam endstop (sold in pairs).

Part No.	Description	Splice link	Endstop	Ordering information	Fastening method
2720	Small Boat track	2724	263	page 104	Drilling and tapping

Mounting Kits and Endstops

Mounting kit slugs are available for flat or round mast grooves. Order one kit per track section.

Use screwpin endstop to easily remove cars and mainsail. Order one kit only.

MOUNTING KIT

3804
3805
3806



ENDSTOP KIT/FIXED

3808
3809
3810



Mainsail luff length		Number of 3807 track sections
ft*	m*	
26'4" - 33'	8.03 - 10.06	5
33'1" - 39'9"	10.08 - 12.11	6
39'10" - 46'5"	12.13 - 14.16	7
46'6" - 53'2"	14.19 - 16.21	8
53'3" - 59'11"	16.24 - 18.26	9

*Track extends above sail luff. Using screwpin endstop kits will increase lengths.

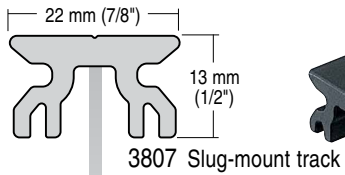

3807 Slug-mount track

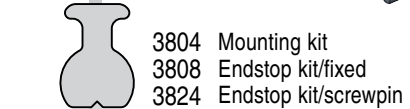

3804 Mounting kit
3808 Endstop kit/flat

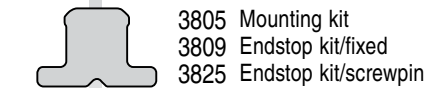

3805 Mounting kit
3825 Endstop kit/screwpin

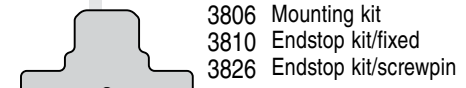

3806 Mounting kit
3826 Endstop kit/screwpin

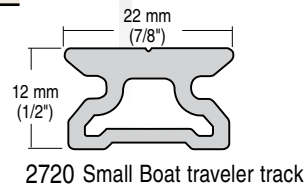

2720 Small Boat traveler track

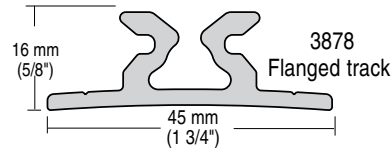

3878 Flanged track

ENDSTOP KIT/SCREWPIN

3824
3825
3826



Track Mounting Kits: Slug Mount*

Part No.	Description	Mounting slug				Mounting slugs/kit	Connector slug				Fits flat mast groove gap				
		Length		Weight			Length		Weight		Min	Max			
		in	mm	oz	g		in	mm	oz	g	in	mm	in	mm	
3804	Round mast groove	3/4	19	0.14	4	15	2 5/8	67	0.54	15	1				
3805	Flat mast groove	3/4	19	0.17	5	15	2 5/8	67	0.6	17	1	5/16	8	7/16	11
3806	Wide flat mast groove**	3/4	19	0.25	6	15	2 5/8	67	0.94	23	1	7/16	11	5/8	16

Endstop Kits: Slug Mount*

Part No.	Description	Track end length		Weight		Mounting slugs/kit
		in	mm	oz	g	
3808	Round mast groove/flat (pair)			0.5	14	2
3809	Flat mast groove/flat (pair)			0.52	15	2
3810	Wide flat mast groove/flat (pair)			0.67	19	2
3824	Round mast groove/screwpin	8	203	5.4	155	3
3825	Flat mast groove/screwpin	8	203	5.5	157	3
3826	Wide flat mast groove/screwpin	8	203	6.1	174	3

*Includes M5 X .8 X 20/25 mm or 25 mm fasteners.

System B

Typical boat size:

Monohulls: length 15.2 - 18.3 m (50 - 60');
mainsail area under 83 m² (900 ft²)

Multihulls: length 12.2 - 15.2 m (40 - 50');
mainsail area under 65 m² (700 ft²)

About CB and slider Battcar systems: see feature pages
at beginning of this section.



Designed to work with batten receptacles from New Zealand's C-Tech Sailbattens, the pintles have shoulders that protect the threads from bending.

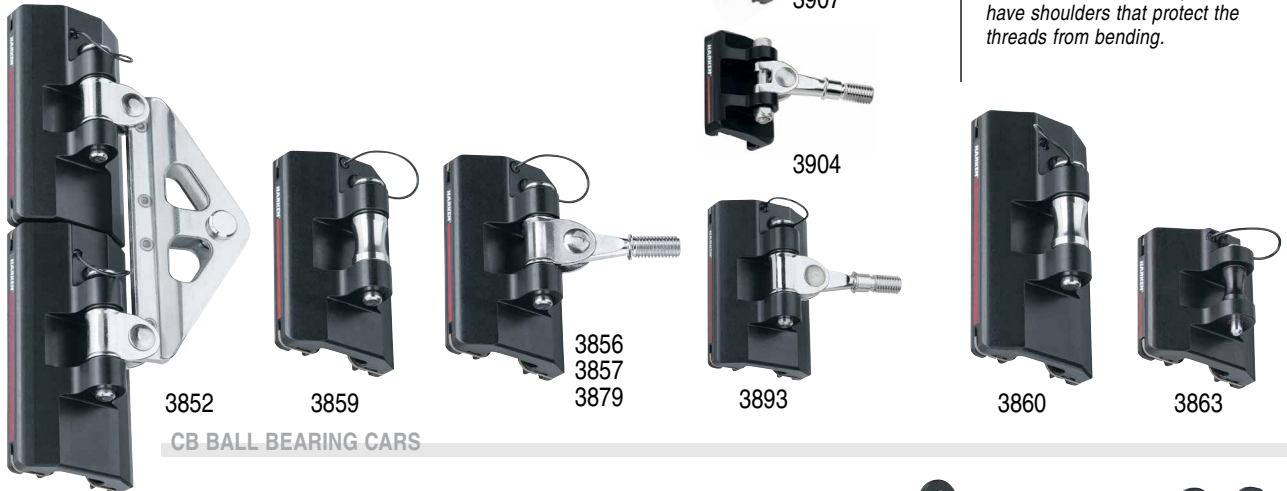

CB BALL BEARING CARS



SLIDER CARS

HEADBOARD PLATES

Aluminum web-on headboard plates are easy for sailmakers to install. Plates have radiused edges to protect the sail and fit 25 mm (1") webbing strap. Holes threaded into plates accept 416 cheek blocks for leech line. Web-on plates are required for the 3852 System B CB headboard car. Sold separately.

Part No.	Description	Length		Width		Weight		Max headboard thickness		Maximum working load	
		in	mm	in	mm	oz	g	in	mm	lb	kg
CB Cars: Typical Boat Length: Monohulls 15.2 - 18.3 m (50 - 60'); Multihulls 12.2 - 15.2 m (40 - 50')											
3852	Headboard car assembly**	10 1/2	267	2 3/4	70	41.4	1173	7/16	12	3200	1450
3863	Intermediate car**	2 9/16	68	2 3/4	70	6.8	191			524	238
3856	Battcar/10 mm stud**	4 1/4	108	2 3/4	70	14.3	406			1260	571
3857	Battcar/12 mm stud**	4 1/4	108	2 3/4	70	14.6	413			1260	571
3879	Battcar/14 mm stud	4 1/4	108	2 3/4	70	15.1	429			1260	571
3859	Universal Battcar ‡	4 1/4	108	2 3/4	70	12.3	348			1260	571
3860	Reef car ‡	5 3/16	132	2 3/4	70	14.4	408			1600	725
3861	Web-on headboard plate	6 3/4	172	6 3/8	161	10.3	292				
3862	Web-on headboard plate/flat-top ‡ ‡	5 13/16	148	6 3/16	157	11.2	317				
3903	Battcar/10 mm stud for C-Tech Batten **	4 1/4	108	2 3/4	70	14.5	413			1260	571
3893	Battcar/12 mm stud for C-Tech batten**	4 1/4	108	2 3/4	70	14.9	423			1260	571
3907	Battcar/14 mm stud for C-Tech batten**	5 3/16	132	2 3/4	70	17.6	500			1600	725
Slider Cars: Typical Boat Length: Monohulls 15.2 - 18.3 m (50 - 60'); Multihulls 12.2 - 15.2 m (40 - 50')**											
3833	Headboard car assembly**	7 1/2	190	1 11/16	42	14.8	420	9/16	16	3200	1450
3836	Intermediate car	2 3/16	56	1 11/16	42	2.9	82			1260	571
3834	Battcar/10 mm stud**	2 3/16	56	1 11/16	42	4.5	128			1260	571
3835	Battcar/12 mm stud**	2 3/16	56	1 11/16	42	4.9	140			1260	571
3904	Battcar/10 mm stud for C-Tech Batten **	2 3/16	56	1 11/16	42	4.5	128			1260	571

See page 275 for replacement balls. *Available as a non-CB car on a car loader to run on a non-CB style track supplied before 2004. Add .NW to end of part number.
**Batten receptacle not included. ‡ Contact Harken for headboard plate for non CB systems. ‡ ‡Fits standard sailmaker-supplied headboard.

System B

About CB and Slider Battcar systems: see feature pages at beginning of this section.

Mainsail luff length		Number of 3844 track section
ft*	m*	
39'10" - 46'6"	12.13 - 14.17	7
46'7" - 53'3"	14.19 - 16.23	8
53'4" - 60'	16.25 - 18.29	9
60'1" - 66'9"	18.31 - 20.35	10
66'10" - 73'6"	20.37 - 22.44	11

*Track extends above sail luff. Using screwpin endstop kits will increase lengths.

Mast Track

3844 track mounts to mast using a unique slug system that allows mast-up installation.

Use flanged track when mounting to carbon spars. Track features a groove for racing sails with boltropes or slugs. Use C10879 endstop feeder kit to easily raise sails with boltropes.

Part No.	Description	Length		Weight		Fastener spacing		Fastening method
		in	m	oz/ft	g/m	in	mm	
3844	Slug-mount track	81 1/8	2.06	5.66	527	3 15/16	100	Mounting slugs
3849.2M	Flanged track	78 3/4	2	12	1119			Adhesive
3849.6M	Flanged track	236 1/4	6	12	1119			Adhesive
C10879	Endstop/feeder kit*	15 3/4	0.4	22.4	636	2 15/16	75	Fasteners/adhesive

*Use with 3849 flanged track. Contact Harken for price and lead time.

Traveler Track: Drill/Tap

For masts without internal sail track, attach R27 Midrange traveler track by drilling and tapping the spar. Join track sections with splice links. Order one per track section. Order one low-beam endstop (sold in pairs).

Part No.	Description	Splice link	Endstop	Ordering information	Fastening method
R27	Midrange track	1619	E2700	Page 109	Drilling and tapping

Mounting Kits and Endstops

Mounting kit slugs are available for flat or round mast grooves. Order one kit per track section.

Use pinstop endstop to easily remove cars and mainsail. Order one kit only.



3845
3846
3864

■ MOUNTING KIT



■ ENDSTOP KIT/FIXED



■ ENDSTOP KIT/SCREWPIN



■ ENDSTOP/FEEDER KIT

Track Mounting Kits: Slug Mount*

Part No.	Description	Mounting slug				Mounting slugs/kit	Connector slug				Fits flat mast groove gap				
		Length		Weight			Length		Weight		Min		Max		
		in	mm	oz	g		in	mm	oz	g	Connector slugs/kit	in	mm	in	mm
3845	Round mast groove	7/8	22	0.43	12	19	3	76	1.27	36	1	7/16	11	5/8	16
3846	Flat mast groove	7/8	22	0.56	16	19	3	76	1.71	48	1	7/16	11	5/8	16
3864	Flat mast groove**	7/8	22	0.48	14	19	3	76	1.29	37	1	3/8	9.5	7/16	11

Endstop Kits: Slug Mount*

Part No.	Description	Track end length		Weight		Mounting slugs/kit
		in	mm	oz	g	
3847	Round mast groove/pinstop	9 1/2	241	8.3	234	3
3848	Flat mast groove/pinstop	9 1/2	241	11.3	322	3
3850	Round mast groove/fixd (pair)			3.3	94	2
3851	Flat mast groove/fixd (pair)			3.7	105	2
3865	Flat mast groove/fixd**			3.5	100	2
3866	Flat mast groove/pinstop**	9 1/2	241	11.1	316	3

*Includes M6 x 1.0 x 20 or 30 mm fasteners; weights include fasteners; not for flanged track.

**For Selden mast section C installations.

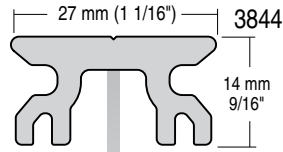

3844 Slug-mount track

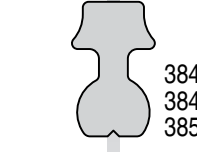

3845 Mounting kit
3847 Endstop kit/pinstop
3850 Endstop kit/fixd

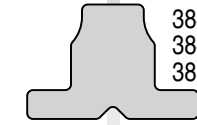

3846 Mounting kit
3848 Endstop kit/pinstop
3851 Endstop kit/fixd

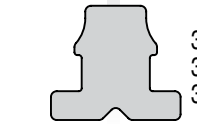

3864 Mounting kit
3865 Endstop kit/fixd
3866 Endstop kit/pinstop

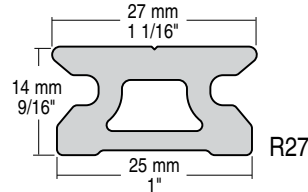

R27 Midrange traveler track

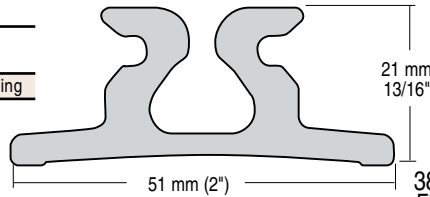

3849 Flanged track

System C

Typical boat size:

Monohulls: length 18.3 - 27 m (60 - 90');
mainsail area under 180 m² (1940 ft²)

Multihulls: length 15.2 - 21 m (50 - 70');
mainsail area under 140 m² (1510 ft²)

About CB and slider Battcar systems: see feature pages at beginning of this section.

Pelagic Belle, Knysna 500, Angelo Lavranos, Knysna Yacht Company © Rika Fouché



Designed to work with batten receptacles from New Zealand's C-Tech Sailbattens, the pintles have shoulders that protect the threads from bending.



3876



3877

Aluminum web-on headboard plates are easy for sailmakers to install. Plates have radiused edges to protect the sail and fit 25 mm (1") webbing strap. Holes threaded into plates accept 416 cheek blocks for leech line. Web-on plates are required for the 3867 System C CB headboard car. Sold separately.



3867



3873



3872



3868
3869
3870



3890
3891
3945



3871

Part No.	Description	Length		Width		Height		Weight		Max headboard thickness		Maximum working load	
		in	mm	in	mm	in	mm	oz	g	in	mm	lb	kg
CB Cars: Typical Boat Length: Monohulls 18.3 - 27 m (60 - 90'); Multihulls 15.2 - 21 m (50 - 70')													
3867	Headboard car assembly*	18 5/8	473	3 3/8	85			107	2980	9/16	15	6300	2858
3871	Intermediate car	3 3/4	96	3 3/8	85			17	493			1530	695
3868	Battcar/12 mm stud**	5 3/8	136	3 3/8	85			29	834			2100	953
3869	Battcar/14 mm stud**	5 3/8	136	3 3/8	85			30	844			2100	953
3870	Battcar/16 mm stud**	5 3/8	136	3 3/8	85			31	860			2100	953
3872	Universal Battcar**	5 3/8	136	3 3/8	85			24	676			2100	953
3873	Reef car	9 1/8	231	3 3/8	85			38	1071			3150	1429
3876	Web-on headboard plate*	10 15/16	278	9/16	14	10 5/8	269	33.8	958.4	1/2	13		
3877	Web-on headboard plate/flat-top*	11 1/16	281	9/16	14	11 5/16	288	43	1343	1/2	13		
3890	Battcar/M12 stud for C-Tech batten**	5 3/8	136	3 3/8	85			29.5	836			2100	953
3891	Battcar/M14 stud for C-Tech batten**	5 3/8	136	3 3/8	85			29.9	847			2100	953
3945	Battcar/M16 stud for C-Tech batten**	5 3/8	136	3 3/8	85			31.5	894			2100	953

See page 275 for replacement balls. *Contact Harken for headboard plate for older systems. **Batten receptacle not included.

System C

About CB and slider Battcar systems: See feature pages at beginning of this section.

Mast Track

3853 track mounts to mast using a unique slug system that allows mast-up installation.

Use flanged track when mounting to carbon spars. Track features a groove for racing sails with boltropes or slugs.

Part No.	Description	Length		Weight		Fastener spacing	Fastening method
		in	m	oz/ft	g/m		
3853	Slug-mount track	81 15/16	2.08	9.28	863	3 15/16 100	Mounting slugs
3858.2M	Flanged track	78 3/4	2	17.38	1619		Adhesive
3858.6M	Flanged track	236 1/4	6	17.38	1619		Adhesive

Traveler Track: Drill/Tap

For masts without internal sail track, attach R32 Big Boat traveler track by drilling and tapping the spar. Join track sections with splice links. Order one per track section. Order one low-beam endstop (sold in pairs).

Part No.	Description	Splice link	Endstop	Ordering information	Fastening method
R32	Big Boat track	3153	E3200	page 115	Drilling and tapping

Mounting Kits and Endstops

Mounting kit slugs are available for flat mast grooves. Order one kit per track section.

Use pinstop endstop to easily remove cars and mainsail. Order one kit only.

MOUNTING KIT

3854



ENDSTOP KIT/FIXED

3855



ENDSTOP KIT/SCREWPIN

3875



Track Mounting Kits: Slug Mount

Part No.	Description	Mounting slug				Mounting slugs/kit	Connector slug				Fits flat mast groove gap				
		Length	Weight	Length	Weight		Length	Weight	Connector slugs/kit	Min	Max	Min	Max		
in	mm	oz	g	in	mm	oz	g	in	mm	in	mm	in	mm		
3854	Flat mast groove	1	25	0.6	17	19	4 1/8	105	2.49	70	1	17/32	13	5/8	16

Endstop Kits: Slug Mount

Part No.	Description	Track end length		Weight		Mounting slugs/kit
		in	mm	oz	g	
3855	Flat mast groove/fixed (pair)*			16	454	2
3875	Flat mast groove/pinstop*	17	432	30	853	5

M8 x 1.25 x 40 mm fasteners. *Not for flanged track.

Mainsail luff length	Number of 3853 track sections	
	ft*	m*
53'8" - 60'5"	16.36 - 18.42	9
60'6" - 67'3"	18.45 - 20.50	10
67'4" - 74'1"	20.53 - 22.58	11
74'2" - 80'11"	22.61 - 24.66	12
81" - 87'9"	24.69 - 26.74	13
87'10" - 94'7"	26.77 - 28.82	14
94'8" - 101'5"	28.85 - 30.90	15

*Track extends above sail luff. Using screwpin endstop kits will increase lengths.

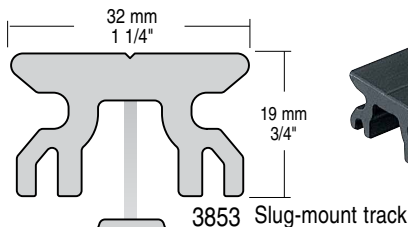

3853 Slug-mount track

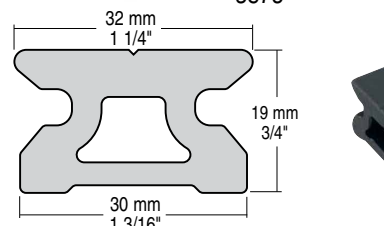
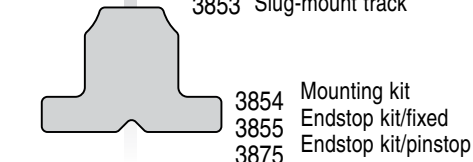

R32 Big Boat traveler track

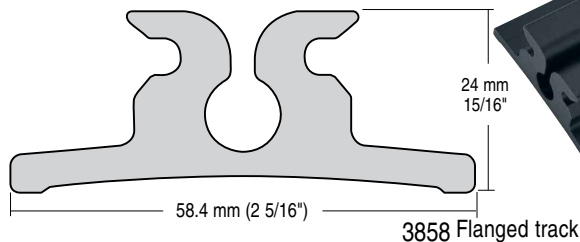

3858 Flanged track



SWITCH T-TRACK BATTCAR SYSTEMS

Harken's award-winning Switch T-Track Battcar system cuts the stack height of mainsails on large yachts by half, making it much easier for crew to put on sail covers and to connect/disconnect halyards. This simple, yet sophisticated patented switch system neatly stacks cars side-by-side on top of the boom. The unique switch plate has no moving parts, ensuring an exceptionally reliable and efficient product. Available in 18, 26, 32, and 40 mm sizes for monohulls 11 m (37') to over 43 m (140'); multihulls 9 m (30') to over 27 m (90').



Switch track cuts stack height in half

- Neatly flakes mainsail on top of the boom; stores cars on parallel tracks.
- Headboard cars articulate, pass through switch for further stack height reduction (26 and 32 mm).
- Long switches available to accommodate more cars on boats with large sail areas.



Stand up to sun, salt, and time

- 18 mm high-load, 26, 32, and 40 mm aluminum cars Hard Lube-anodized, UV-stabilized for durability.
- Standard 18 mm cars fiber-reinforced, UV-stabilized, lubricated composite for maximum protection and low wear.
- Aluminum track hardcoat-anodized for a long-lasting surface.
- Switch plate has no moving parts to break.

Materials

For properties see pages 253-254.



6061-T6 aluminum:

Hard Lube-anodized cars; hardcoat-anodized track

Do not use Harken equipment for human suspension unless product is specifically certified and labeled for such use.



Low-friction components

- Cars run on low-friction plastic slides.
- Switch plate with no moving parts minimizes friction.



Easy installation/removal of cars

- Gate tracks for 26, 32, 40 mm cars feature easy-to-remove fasteners to load/unload cars.
- 18 mm switch track uses screwpin stops and stop at masthead for easy car removal.



Optional Trysail Switch system reduces weight aloft

- Integrates trysail with mainsail switch systems; shares track.
- Cars switch automatically—only trysail cars travel onto the trysail track; mainsail cars pass through to switch and storage tracks.
- All track is hardcoat-anodized.
- Available in 26, 32, and 40 mm sizes.

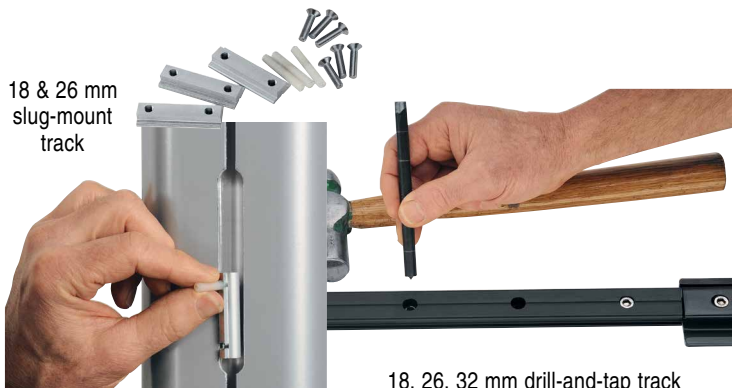

Variety of mounting options

- 18 and 26 mm slug-mount track converts masts with sail grooves for mast-up installation. Boats under 12.2 m (40') use standard slug-mount track. Boats from 12.2 - 13.7 m (40' - 45') require 18 mm high-load slug-mount track at full hoist and all reef point headboard locations. 18 mm systems available for round, flat, or wide flat mast grooves. Boats from 13.7 - 24.4 m (45' - 80') use 26 mm slug-mount track. 26 mm available with flat mast groove slugs.
- 18, 26, 32 mm drill/tap track and switches fit masts without sail grooves; join track sections with splice links.
- 26, 32, and 40 mm flange track is available in bond and bolt-down versions. Bond track is joined to the mast with a structural adhesive to reduce weight aloft; eliminates the majority of track fasteners for lighter-weight system. Consult mast builder for bond track installation recommendations.

18 mm Switch T-Track Battcar Systems

Typical boat size:

18 mm: Monohulls: 11 - 13.5 m (37-45');
Multihulls: 9 - 10.5 m (30-35')

18 mm high-load:

Monohulls 13.5 - 15 m (45 - 50');
Multihulls 10.5 - 12 m (35 - 40')

About Switch T-Track Battcar systems: see feature pages at beginning of this section.

Designed to work with batten receptacles from New Zealand's C-Tech Sailbattens, the pintles have shoulders that protect the threads from bending.



HC7905



HC7905HL



3905



3906



HC7904HL
HC8537HL



HC8537



HC7906



HC7906HL

INTERMEDIATE CARS

BATTEN CARS

HEADBOARD CARS

Xc 42, Niels Jeppensen@X-Yachts



Cut car stack height in half by flaking the sail alternately to port and starboard of the boom.

BATTCAR Q&A

WHY DO I WANT A SWITCH BATTCAR SYSTEM?

A Switch Battcar system cuts stack height in half, so putting on a sail cover or connecting/disconnecting your halyard is a much easier task. The patented system works by alternately dropping mainsail cars onto port and starboard storage racks. Headboard cars articulate and pass through the switch, reducing stack height even more.

Cars

Part No.	Description	Length		Width		Weight		Max headboard thickness		Maximum sail area				Maximum working load	
		in	mm	in	mm	oz	g	in	mm	ft ²	m ²	ft ²	m ²	lb	kg
18 mm															
HC7906	Headboard car	7 3/16	198	1 21/32	42	12.8	359	9/16	14	450	40	325	30	700	318
HC7905	Intermediate car	2 1/2	63	1 21/32	42	1.6	45			450	40	325	30	300	136
HC8537	Batten car/10 mm stud	2 1/2	63	1 21/32	42	3.2	91			450	40	325	30	300	136
3905	Batten car/10 mm stud for C-Tech Batten	2 1/2	63	1 21/32	42	3.5	100			450	40	325	30	300	136
18 mm High-Load (HL)															
3892	Battcar/M12 stud for C-Tech batten	2 1/2	63	1 11/16	42	4.8	135			610	55	500	45	600	272
HC7906HL	Headboard car	7 3/16	198	1 21/32	42	14.4	408	9/16	14	610	55	500	45	1600	725
HC7905HL	Intermediate car	2 1/2	63	1 21/32	42	3.2	91			610	55	500	45	600	272
HC7904HL	Batten car/12 mm stud	2 1/2	63	1 21/32	42	4.9	139			610	55	500	45	600	272
HC8537HL	Batten car/10 mm stud	2 1/2	63	1 21/32	42	4.8	136			610	55	500	45	600	272
3906	Batten car/10 mm stud for C-Tech Batten	2 1/2	63	1 21/32	42	4.8	136			610	55	500	45	600	272

18 mm Switch T-Track Battcar Systems

For masts with sail grooves, 18 mm slug-mount track uses a unique system that allows mast-up installation. Use high-load slug-mount tracks on boats over 12.2 m (40') at sail headboard locations at full hoist and headboard locations when sail is reefed. Drill/tap track and switches fit masts without sail grooves. Join drill/tap track sections with splice links. Order one per track section. Boats with larger sail areas should use long switches to accommodate more cars.

Mounting Kits and Endstops

Slug mounting kits are available for flat or round mast grooves. Order one kit per track section.

Switch track includes screwpin stops for easy car and sail removal below switch. Stop at masthead also included.

About Switch T-Track Battcar systems: see feature pages at beginning of this section.

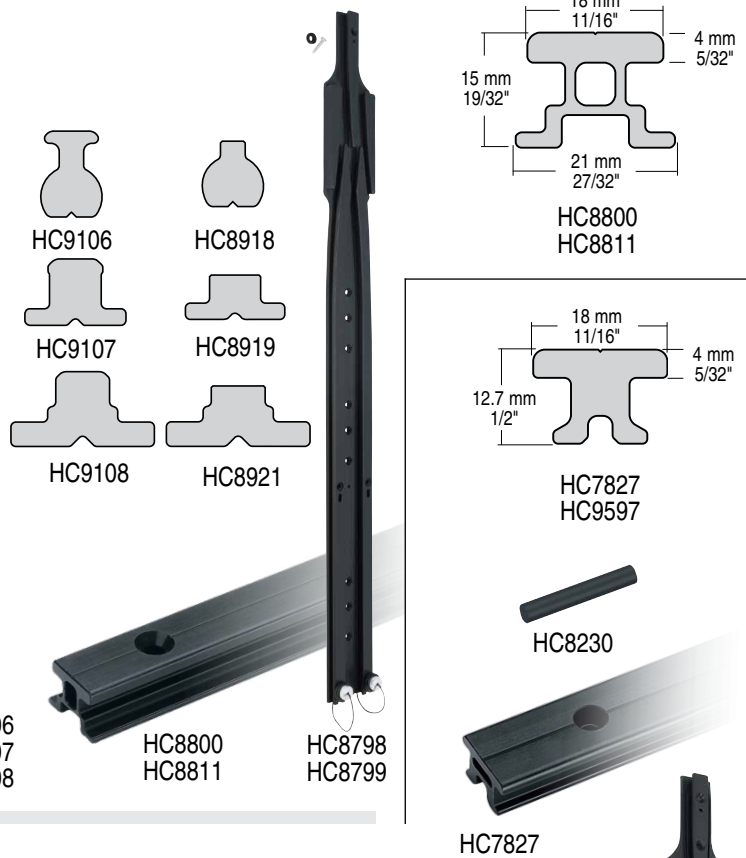
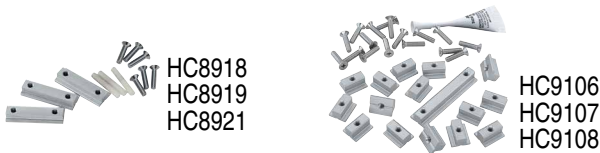

SLUG MOUNT

Mounting Kits: Slug Mount

Part No.	Description	Mounting slug			Connector slug			Flat mast groove gap			
		Length in	Weight oz	Mounting slugs/kit	Length in	Weight oz	Connector slugs/kit	Min in	Max in		
Switch Mounting Kits											
HC8918	Round mast groove	2	51	0.32	9	3					
HC8919	Flat mast groove	1 3/4	45	0.28	8	3		5/16	8	7/16	11
HC8921	Wide flat mast groove	1 3/4	45	0.56	16	3		7/16	11	5/8	16
Track Mounting Kits											
HC9106	Round mast groove	3/4	19	0.14	4	19	2 5/8	67	0.54	15	1
HC9702	Round mast groove, extras*	3/4	19	0.14	4	10					
HC9107	Flat mast groove	3/4	19	0.17	5	19	2 5/8	67	0.6	17	1
HC9703	Flat mast groove, extras*	3/4	19	0.17	5	10					
HC9108	Wide flat mast groove	3/4	19	0.25	6	19	2 5/8	67	0.94	23	1
HC9704	Wide flat mast groove, extras*	3/4	19	0.25	6	10					

*Extra slug kit for HC8811 track. Order one kit in addition to HC9106, HC9107 or HC9108 for sail headboard location at full hoist and one kit for each reefed headboard location.

Track

Part No.	Description	Length		Width		Weight		Fasteners	Fastener spacing
		in	mm	in	mm	oz	g		
Slug Mount									
HC8798	Switch/short	24	610	2 5/8	67	32	907	5	
HC8799	Switch/long	33 3/4	857	2 5/8	67	47	1336	5	
HC8800	T-Track	80	13/16	2051	27/32	21	26.7	758	5
HC8811	T-Track/high-load**	80	13/16	2051	27/32	21	26	748	5
Drill/Tap									
HC10417	Switch***	33 3/4	857	3	76	26.7	758	5	75
HC7827	3 m T-Track	118	1/8	3000	23/32	18	38.9	1106	5
HC9597	2 m T-Track/high load	78	3/4	2000	23/32	18	25.5	723	5
HC8230	Splice link	7/8	22	1/8	3.2	0.02	0.57		

** Use HC8811 high-load track on upper part of mast to reinforce HL system headboard locations. Mount using 50 mm hole spacing at headboard location at full hoist and headboard location at each reef point. Reduce weight in other areas by alternating holes to 100 mm spacing.

***Switch may be shortened to 605 mm (23 13/16").



DRILL/TAP

26 mm, 32 mm Switch T-Track Battcar Systems

Patented Battcar switch systems cut sail stack height in half by automatically splitting cars onto two tracks.

Use HC8879 and HC8880 for headboard reefed position. See page 151. Gate track is removed to load and unload cars.

Spherical bushings let headboard cars pass through switch.

Typical boat size:

26 mm: Monohulls: 15 - 24 m (50 - 80');
Multihulls: 12 - 18 m (40 - 60')

32 mm: Monohulls: 24 - 43 m (80 - 140');
Multihulls: 18 - 27 m (60 - 90')

About Switch T-Track Battcar systems: see feature pages at beginning of this section.

HEADBOARD CAR ASSEMBLY

HC9045 and HC9046 use 3876 or 3877 headboard plates.**



HC9045
HC9046



Designed to work with batten receptacles from New Zealand's C-Tech Sailbattens, the pintles have shoulders that protect the threads from bending.



HC7493



HC7322



HC7325



HC8076



HC8125
HC8099



3876



3877

HEADBOARD PLATES

INTERMEDIATE CARS

REEF CARS

TACK CAR



HC7324



HC8098



HC7316



3894
3896
3897



3895

BATTEN CARS

Cars

Part No.	Description	Length		Width		Weight		Max headboard thickness		Maximum sail area		Maximum working load			
		in	mm	in	mm	oz	g	in	mm	ft ²	m ²	ft ²	m ²	lb	kg
26 mm															
HC9045	Headboard car*	10 5/8	270	2 3/8	60	34.3	973	21/32	17	1730	160	1300	120	4500	2045
HC7493	Intermediate car	2 3/8	60	2 3/8	60	5.6	159			1730	160	1300	120	1000	454
HC7324	Batten car/12 mm stud	2 15/16	75	2 3/8	60	8.8	250			1730	160	1300	120	1500	680
HC7325	Reef car*	3 17/32	90	2 3/8	60	7.2	205			1730	160	1300	120	2100	952
HC8125	Tack car	3 17/32	90	4 3/8	111.2	14.4	409			1730	160	1300	120	3800	1723
3894	Battcar/M12 stud for C-Tech batten	2 15/16	75	2 3/8	60	9.1	257			1730	160	1300	120	1500	680
3895	CRX Battcar/M12 stud for C-Tech batten	4 1/2	115	2 3/8	60	12.6	357			1730	160	1300	120	1500	680
32 mm															
HC9046	Headboard car*	11	280	2 3/4	70	44.7	1266	21/32	17	3780	350	2400	225	8000	3628
HC7322	Intermediate car	2 15/16	75	2 3/4	70	10.4	297			3780	350	2400	225	2800	1270
HC8098	Batten car/12 mm stud	3 17/32	90	2 3/4	70	11.2	319			3780	350	2400	225	4000	1814
HC7316	Batten car/14 mm stud	3 17/32	90	2 3/4	70	11.2	319			3780	350	2400	225	4000	1814
HC8076	Reef car*	4 17/32	115	2 3/4	70	14.4	409			3780	350	2400	225	6000	2722
HC8099	Tack car	4 17/32	115	5 3/16	132	29.2	830			3780	350	2400	225	7900	3583
3896	Battcar/M12 stud for C-Tech batten	3 17/32	90	2 3/4	70	17.1	487			3780	350	2400	225	4000	1814
3897	Battcar/M14 stud for C-Tech batten	3 17/32	90	2 3/4	70	17.2	489			3780	350	2400	225	4000	1814
Headboard Plates															
3876	Web-on headboard plate**	10 15/16	278	9/16	14	33.8	958.4	1/2	13					Fits HC9045/HC9046	
3877	Web-on headboard plate/flat-top**	11 1/16	281	9/16	14	43	1343	1/2	13					Fits HC9045/HC9046	

*May increase mwl by using track with closer hole spacing; contact Harken. **Contact Harken for headboard plate for older systems and boats

Switch T-Track Battcar Systems: 26, 32 mm

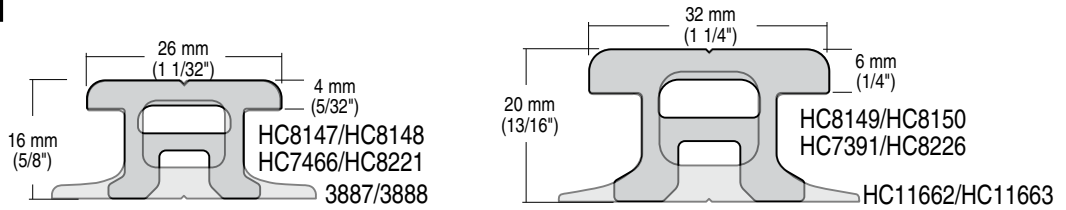

Track Mounting Kits: Slug-Mount

Part No.	Description	Mounting slug length		Mounting slugs/kit	Weight (kit)		Fasteners (included)	Track
		in	mm		oz	g		
3884	Track slug-mounting kit/flat mast groove	1	25	40	28	790	40 x M6 x 1.0 x 18 mm	HC7466, HC8879

Endstop Kits: Slug-Mount

Part No.	Description	Mounting slug length		Mounting slugs/kit	Track length		Weight (kit)		Fasteners (included)	
		in	mm		in	mm	oz	g		mm
3885	Endstop kit/flat mast groove*	1	13/32	36	1	2.25	64	2 x M6 x 1.0 x 35 mm		
3886	Gate track mounting kit/flat mast groove**	1	25	4	11	13/16	300	9.25	260	4 x M6 x 1.0 x 18 mm

*Includes 1522ASSY. **Includes HC8221.

Track & Accessories

Part No.	Description	Length		Width		Weight		Fasteners	Fastener spacing
		in	mm	in	mm	oz	g		
26 mm									
3887	Flange track/bolt-down*	74 3/4	1899	1 1/32	26	41.6	1180	6	50
3888	Flange track/bond*	153 1/2	3899	1 1/32	26	88.2	2500	6	3850
HC8220	Switch*	25 1/4	641	4	102	43.1	1225	6	
HC8147	500 mm storage track*	19 11/16	500	1 1/32	26	10.2	291	6	50
HC8148	725 mm storage track*	28 17/32	725	1 1/32	26	14.8	419	6	50
HC10060	725 mm double storage track*	28 17/32	725	3 11/16	93	57.2	1623	6	50
HC7466	3 m T-Track*	118 1/8	3000	1 1/32	26	61.1	1736	6	75
HC8879	2 m T-Track/high-load*	78 3/4	2000	1 1/32	26	40.3	1141	6	50
HC8221	Gate track*	11 13/16	300	1 1/32	26	6.1	174	6	75
HC8222	Splice link			1 1/32	26	0.1	3		
1522ASSY	Endstop	2 5/32	55	1 17/32	39				
32 mm									
HC7382	Switch*	28 1/2	724	5	127	72.8	2068	8	
HC8149	800 mm storage track*	31 1/2	800	1 1/4	32	25.6	728	8	50
HC8150	1025 mm storage track*	40 11/32	1025	1 1/4	32	32.8	933	8	50
HC7391	3 m T-Track*	118 1/8	3000	1 1/4	32	96.2	2734	8	75
HC8880	2 m T-Track/high-load*	78 3/4	2000	1 1/4	32	63.1	1790	8	50
HC8226	Gate track*	11 13/16	300	1 1/4	32	9.6	273	8	75
HC8227	Splice link					0.2	5		
HC11662	Flange track/bolt-down*	74 3/4	1899	1 1/4	32	62.1	1760	8	50
HC11663	Flange track/bond*	153 1/2	3899	1 1/4	32	136.2	3860	8	3850
548ASSY	Endstop	2 27/32	72	2 1/32	52				
3948	300 mm Double Storage Track*	11 13/16	300	4 3/8	112	29.7	844		50
3949	500 mm Double Storage Track*	19 11/16	500	4 3/8	112	50	1417		50

*Available in black or clear anodized.



40 mm Switch T-Track Battcar Systems

Patented Battcar switch systems cut sail stack height in half by automatically splitting cars onto two tracks.

Typical boat size:

Monohulls: over 43 m (140');

Multihulls: over 27 m (90')

About Switch T-Track Battcar systems: see feature pages at beginning of this section.



SW-RP90 CUSTOM, Courtesy of Southern Wind Shipyard



3929
3930

REPLACEMENT STUDS



3920

HEADBOARD PLATE



3925



3932
3931



3926

BATTEN CARS



3921

HEADBOARD CAR



3924

INTERMEDIATE CAR



3923

REEF CAR



3922

TACK CAR

Replacement Studs

Part No.	Description	Ø		Fits
		in	mm	
3929	18 mm toggle/stud	23/32	18	3926, 3931, 3932
3930	16 mm toggle/stud	5/8	16	3926, 3931, 3932

Cars

Part No.	Description	Length		Width		Weight		Maximum sail area				Maximum working load	
		in	mm	in	mm	oz	g	ft ²	m ²	ft ²	m ²	lb	kg
3921	Non-locking headboard car assembly	13 3/4	349	3 1/2	89	151	4280	3780 +	350 +	2400 +	275 +		
3924	Intermediate car	3 21/32	93	3 1/2	89	14	392	3780 +	350 +	2400 +	275 +	3549	1613
3932	Batten car/16 mm stud	5 1/32	128	3 1/2	89	34.5	979	3780 +	350 +	2400 +	275 +	5940	2700
3931	Batten car/18 mm stud	5 1/32	128	3 1/2	89	35.3	1000	3780 +	350 +	2400 +	275 +	5940	2700
3925	CRX roller batten car	6 1/16	153	3 1/2	89	37	1045	3780 +	350 +	2400 +	275 +	5940	2700
3926	Universal batten car	5 1/32	128	3 1/2	89	22	617	3780 +	350 +	2400 +	275 +	5940	2700
3923	Reef car	6 1/16	153	3 1/2	89	30	843	3780 +	350 +	2400 +	275 +	8998	4090
3922	Tack car	6 1/16	153	7 1/4	184	81	2303	3780 +	350 +	2400 +	275 +	13200	6000
Headboard Plate													
3920	Web-on headboard plate	13 11/16	348	5/8	16	70.2	1990						

Contact Harken to request lead time. If your boat or sail area is larger than the lengths and sail areas listed, please contact Harken.

Switch T-Track Battcar Systems: 40 mm



Claude, Baltic 68, 19.5 m (64'), naval architect: Reichel Pugh Yacht Design © Baltic Yachts

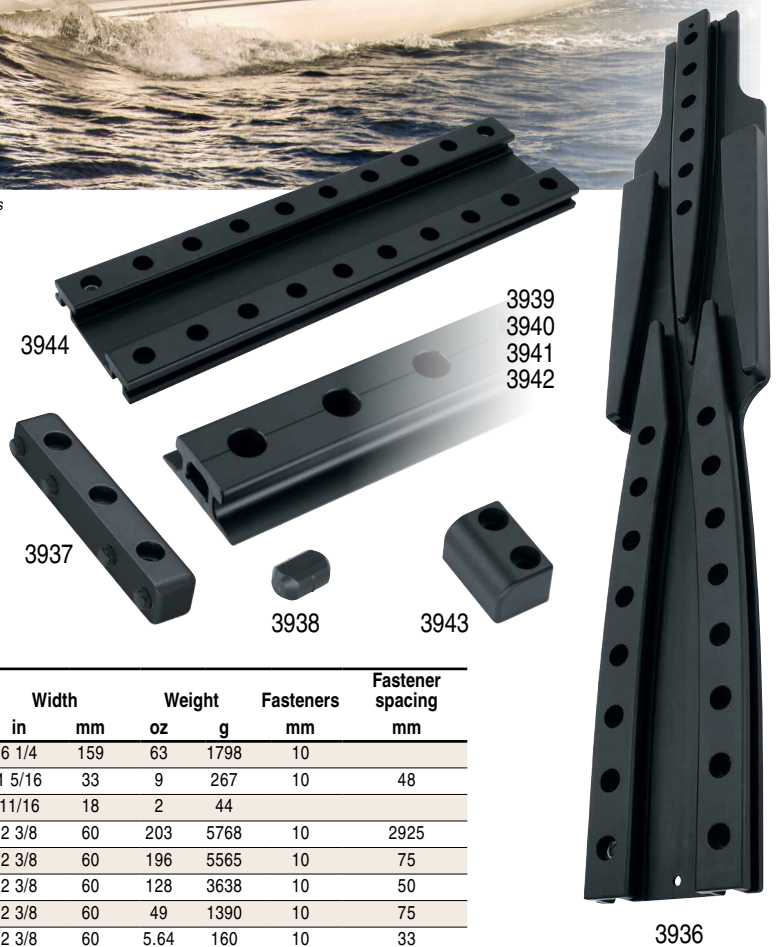
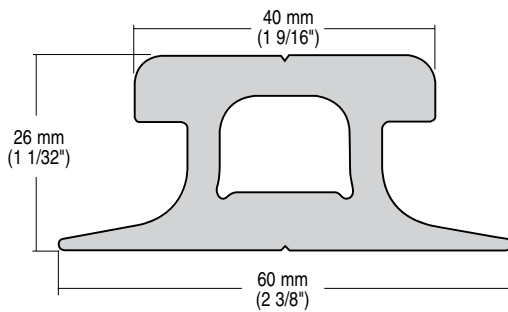

Track & Accessories

Part No.	Description	Length		Width		Weight		Fasteners	Fastener spacing
		in	mm	in	mm	oz	g		
3936	Switch*	36 1/2	927	6 1/4	159	63	1798	10	
3937	Endstop*	5 13/16	148	1 5/16	33	9	267	10	48
3938	Splice link	1	25	11/16	18	2	44		
3939	3 m Flange track/bond*	118 1/16	2999	2 3/8	60	203	5768	10	2925
3940	3 m Flange track/bolt-down*	118 1/16	2999	2 3/8	60	196	5565	10	75
3941	2 m T-Track/high-load*	78 11/16	1999	2 3/8	60	128	3638	10	50
3942	Gate track*	29 1/2	749	2 3/8	60	49	1390	10	75
3943	Top endstop*	1 1/2	38	2 3/8	60	5.64	160	10	33
3944	Double storage track*	19 11/16	500	5 15/32	139	91	2590	10	50

Contact Harken to request lead time. *Available in black or clear anodized.

Trysail Switch System

The Trysail Switch allows the mainsail and trysail to share a single track, greatly reducing weight aloft. This asymmetrical switch installs above the standard system and provides a crossover for trysail cars to utilize the mainsail track. The trysail cars are loaded at deck level and travel past the gooseneck and flaked mainsail onto the mainsail track. Switching of the cars is totally automatic; only trysail cars can travel onto the trysail track, while the mainsail cars pass through to the standard switch and storage tracks.

Track

Use standard Switch system T-Track (see pages 149 and 151).

The track's compound bend wraps around the mast section so cars pass next to the mainsail cars on the storage tracks, past the gooseneck and down to the deck. There crew can safely load the trysail onto the track and raise the sail, leaving the mainsail flaked on the boom.

The compound track bend is determined by installer. Cars must not be under load in curved section.

About Switch T-Track Battcar systems: See feature pages at beginning of this section.



C9492
C9493
C9340
C9341
3934
3935

C10539
C10419
3933



C9494
C9342



3928



The Trysail Switch system integrates with the Switch T-Track Battcar system by sharing a single mast track to reduce weight aloft.

Part No.	Description	Length		Width		Weight		Fasteners	Maximum working load		Fits track
		in	mm	in	mm	oz	g		lb	kg	
26 mm											
C9492	Starboard Trysail Switch*	14 1/2	368	4 25/32	121	27	762	6			HC7466, HC8879
C9493	Port Trysail Switch*	14 1/2	368	4 25/32	121	27	762	6			HC7466, HC8879
C9494	Car body*	2 3/8	60	1 1/32	26	5	143		1001	454	HC7466, HC8879
C10539	Push-button endstop	3 15/16	100	1 1/32	26	3	79	6	435	197	HC7466, HC8879
32 mm											
C9340	Starboard Trysail Switch*	16	406	5 7/8	149	43	1222	8			HC7391, HC8880
C9341	Port Trysail Switch*	16	406	5 7/8	149	43	1222	8			HC7391, HC8880
C9342	Car body*	2 15/16	75	3 1/32	77	11	309		2800	1270	HC7391, HC8880
C10419	Push-button endstop	5 29/32	150	1 17/64	32	4.6	130	8	625	283	HC7391, HC8880
40 mm											
3934	Starboard Trysail Switch*	20	508	7 7/16	189	95	2692	10			3939, 3940, 3941
3935	Port Trysail Switch*	20	508	7 7/16	189	95	2692	10			3939, 3940, 3941
3928	Trysail car*	3 21/32	93	3 21/32	93	14	397		3547	1613	3939, 3940, 3941
3933	Push-button endstop*	5 15/16	150	2 3/8	60	9	269	10			3939, 3940, 3941

Contact Harken to request lead time. *Available in black or clear-anodized.

Ordering Battcar Systems

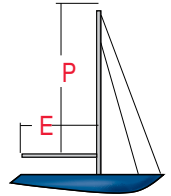
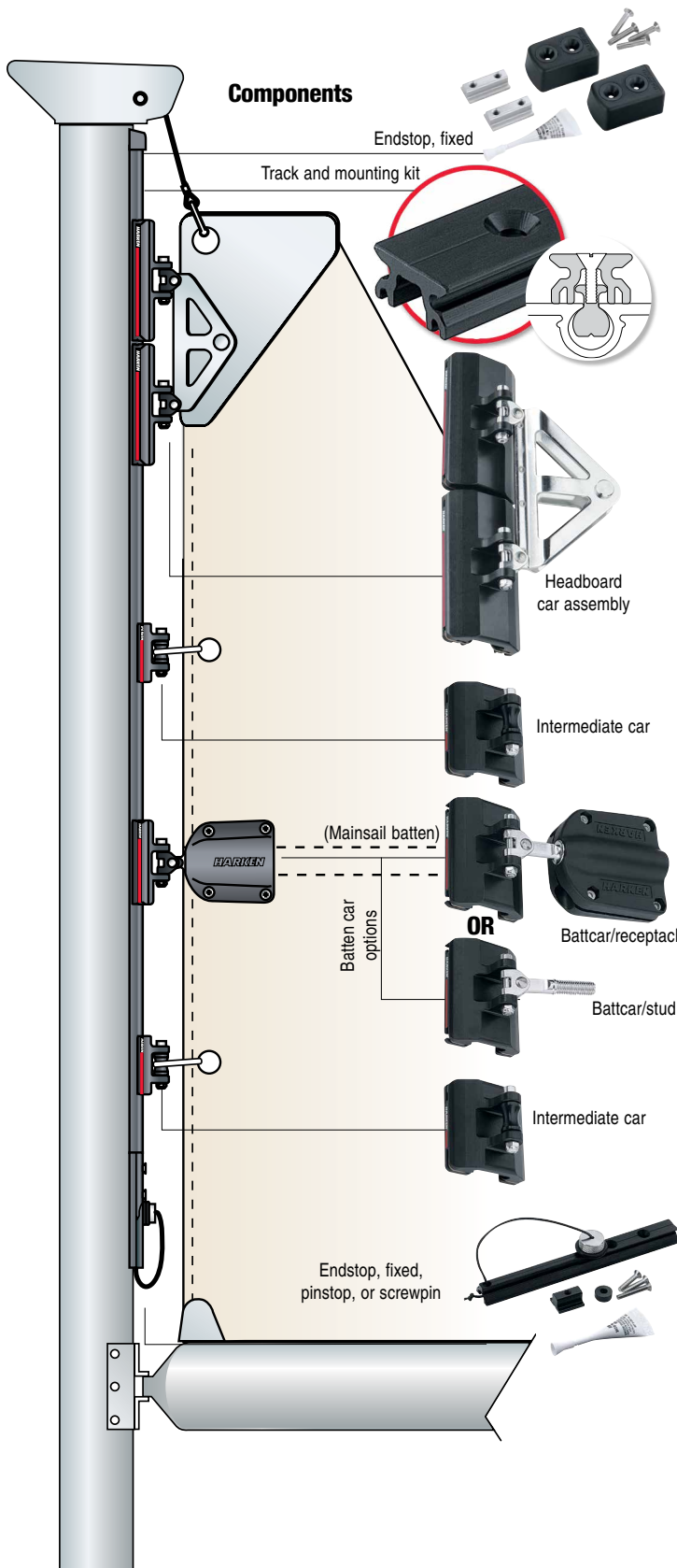

Mainsail Area
P x E x .5

1. Determine System Size

The four sizes, systems AA, A, B, and C, are based on sail area (pages 134-141). If you need to reduce car stack height on mast, see Switch T-Track Battcar Systems (pages 142-149).

System size	Maximum sail area				Typical boat length			
	Monohull		Multihull		Monohull		Multihull	
	ft ²	m ²	ft ²	m ²	ft	m	ft	m
AA	350	32	275	25	a 37	a 11.3	a 30	a 9.1
A	600	56	500	46	37 - 50	11.3 - 15.2	30 - 40	9.1 - 12.2
B	900	83	700	65	50 - 60	15.2 - 18.3	40 - 50	12.2 - 15.2
C	1940	180	1510	140	60 - 90	18.3 - 27	50 - 70	15.2 - 21

2. Determine Track Quantity and Type

Use Mainsail Luff Length chart on each system page to determine number of track sections.

Slug-mount: most common. Requires 1 slug-mount kit per track section. Select slug that matches the mast's boltrope groove shape.

Drill-tap: for masts without a boltrope groove. Requires 1 splice link at each track joint.

3. Choose Endstop Kit

Quick-release: includes screwpin or pinstop endstop for bottom of mast and fixed endstop for the top.

Fixed: Includes two fixed endstops.

4. Choose Cars

Order 1 headboard, 1 Battcar for every full batten, and use the Intermediate Car Chart to determine number of intermediate cars.

CB system: all captive ball bearing components. Lowest friction system for fast sail hoists, douses, and reefs.

Combination system: CB headboard and Battcars, Slider intermediate cars. Reduces cost but uses CB in the most critical load areas.

Slider system: all slider components. Raise and lower sails without jamming the sail in the groove.

Intermediate Cars

Distance between battens*		Intermediate cars between battens
ft	m	
8 or less	2.4 or less	1
9 - 13	2.7 - 4	2
14 - 16	4.3 - 4.9	3

*Boats without full battens should use 1 intermediate CB or slider car per 1.2 m (4') and no Battcars.

5. Contact

If you have questions, please contact your dealer or Harken Technical Service.



Battcar Dimensions

HEADBOARD PLATE

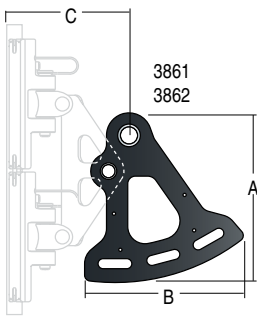

HEADBOARD CAR ASSEMBLY

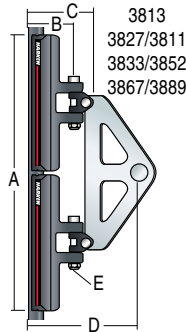

BATTCAR/STUD

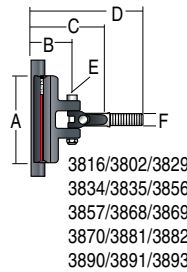

BATTCAR/RECEPTACLE

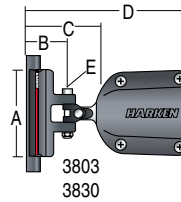

INTERMEDIATE CAR, REEF CAR, UNIVERSAL BATTCAR

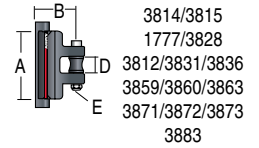

Dimensions (measured from aft face of mast)

Part No.	Description	A		B		C		D		E		F
		in	mm	in	mm	in	mm	in	mm	in	mm	Stud Ø
System AA CB												
3813	CB headboard car assembly	5 3/16	132	1	25	1 13/16	46				5	
3814	Slider intermediate car	1 3/4	44	15/16	24			3/4	19		5	
3815	CB intermediate car	2 3/16	56	1	25			3/4	19		5	
3816	CB Battcar/10 mm stud	2 3/16	56	1	25	1 13/16	46	3 5/16	84		5	10
System A Slider												
3827	Headboard car assembly	6	153	1 1/16	27	2 1/8	54	3 11/16	94	3/16	5	
1777	Low-load intermediate car	2	51	1 1/8	28			3/4	19	3/16	5	
3828	Intermediate car	1 3/4	44	1 1/16	27			2 1/32	17	3/16	5	
3802	Battcar/10 mm stud	1 3/4	44	1 1/16	27	2 1/8	54			3/16	5	10
3803	Battcar/40 mm receptacle	1 3/4	44	1 1/16	27	2 1/8	54	5 1/8	130	3/16	5	
System A CB												
3811	Headboard car assembly	8 3/8	213	1 3/8	35	2 1/4, 2 7/8*	57, 73*	4	102	3/16	5	
3889	Headboard car assembly/quick-release	9 1/2	240	1 3/8	35	2 5/8	68	4 5/16	109	1/4	6	
3812	Intermediate car	2 1/4	57	1 3/8	35			3/4	19	3/16	5	
3829	Battcar/10 mm stud	2 7/8	73	1 3/8	35	2 1/4	57	3 11/16	94	3/16	5	10
3830	Battcar/40 mm receptacle	2 7/8	73	1 3/8	35	2 7/8	73	5 3/4	146	3/16	5	
3831	Universal Battcar	2 7/8	73	1 3/8	35			3/4	19	3/16	5	
3881	Battcar/12 mm stud	2 7/8	73	1 3/8	35	2 3/4	69	3 7/8	99	1/4	6	12
3882	Long batten car/12 mm stud	4 1/8	105	1 3/8	35	2 3/4	69	3 7/8	99	1/4	6	12
3883	Reef car	4 1/8	105	1 3/8	35			3/4	19	1/4	6	
System B Slider												
3833	Headboard car assembly	7 1/2	190	1 1/4	32	2 5/16	59	4 5/8	119	1/4	6	
3836	Intermediate car	2 3/16	56	1 1/4	32					1/4	6	
3834	Battcar/10 mm stud	2 3/16	56	1 1/4	32	2 5/16	59	3 9/16	91	1/4	6	10
3835	Battcar/12 mm stud	2 3/16	56	1 1/4	32	2 5/16	59	3 3/4	96	1/4	6	12
System B CB												
3852	Headboard car assembly	10 1/2	267	1 9/16	39	3 1/16	78	4 1/16	102	3/8	10	
3863	Intermediate car	2 9/16	68	1 9/16	39			3/4	19	1/4	6	
3856	Battcar/10 mm stud	4 5/16	109	1 9/16	39	3 1/16	78	4 3/8	111	3/8	10	10
3857	Battcar/12 mm stud	4 5/16	109	1 9/16	39	3 1/16	78	4 3/8	111	3/8	10	12
3859	Universal Battcar	4 1/4	108	1 9/16	39			1	26	3/8	10	
3860	Reef car	5 3/16	132	1 9/16	39			1	26	3/8	10	
3861	Web-on headboard plate	6 13/16	172	6 3/8	161	4 7/8	124					
3862	Web-on headboard plate/flat-top	5 13/16	147	6 3/16	157	5 23/32	145					
3893	Battcar/M12 stud for C-Tech batten	4 1/4	108	1 9/16	39	3	78	4 1/2	114	3/8	10	12
System C CB												
3867	Headboard car assembly	18 5/8	473	2	51	3 5/8	92	5	126	1/2	12	
3871	Intermediate car	3 3/4	95	2	51			1	26	3/8	10	
3868	Battcar/12 mm stud	5 3/8	136	2	51	3 5/8	92	5 1/16	128	1/2	12	12
3869	Battcar/14 mm stud	5 3/8	136	2	51	3 5/8	92	5 1/16	128	1/2	12	14
3870	Battcar/16 mm stud	5 3/8	136	2	51	3 5/8	92	5 1/16	128	1/2	12	16
3872	Universal Battcar	5 3/8	136	2	51			1 5/16	33	1/2	12	
3873	Reef car	9 1/8	231	2	51			1 5/16	33	1/2	12	
3890	Battcar/M12 stud for C-Tech batten	5 3/8	136	2	51	3 5/8	92	5 5/16	135	1/2	12	12
3891	Battcar/M14 stud for C-Tech batten	5 3/8	136	2	51	3 5/8	92	5 5/16	135	1/2	12	14

*Boltrope setback: with car 3829/with car 3830.

Furling Mainsail Outhaul Systems

Use furling outhaul cars with in-mast or behind-the-mast furlers on boats up to 13.5 m (45'). Sheave carriers pivot side-to-side to accommodate changing lead angles. Systems have 2:1 purchase and ride on cars with Torlon® ball bearings. A deadend outhaul shackle is included.

Cars have axle-bearing sheaves.

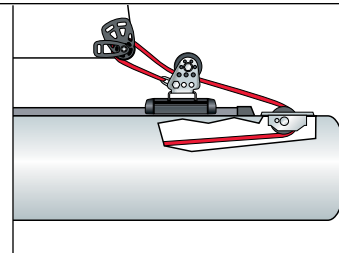

1648



3076



3096

Torlon is a registered trademark of Solvay Advanced Polymers L.L.C.

Part No.	Description	Sheave Ø		Length		Weight		Car width		Maximum working load		Max sail area		Track
		in	mm	in	mm	oz	g	in	mm	lb	kg	ft²	m²	
1648	CB outhaul car	2	51	5 1/4	133	24	680	2 3/4	70	2300	1043	300	28	R27
3076	CB outhaul car	2 1/2	64	5 1/4	133	34	964	3 3/8	85	3000	1361	425	40	R32
3096	CB outhaul car	2 15/16	75	7 1/4	184	62	1758	3 3/8	85	4500	2041	550	51	R32

See page 277 for replacement balls.

Lazy Jacks

Lazy Jacks contain mainsails while reefing and dousing. They work extremely well with full-batten mains, but can also be used with conventional sails.



252
253
254

See "Lazy Jacks" on page 272.

Part No.	Description	Boat length		Boom length		Mainsail luff length	
		ft	m	ft	m	ft	m
252	Small	21 - 28	6.4 - 8.5	7 - 13	2.13 - 3.96	21 - 32	6.4 - 9.75
253	Medium	27 - 37	8.2 - 11.3	10' 6" - 16	3.2 - 4.9	32 - 42	9.75 - 12.8
254	Large	35 - 42	10.7 - 12.8	12 - 16	3.7 - 4.9	35'7" - 48	10.88 - 14.63

Harken Vang-Master

Harken is now collaborating with Marine Products Engineering to offer Vang-Master rigid pneumatic boom vang. Vang-Master boom vangs use air pressure to provide extension force to hold the boom up, without the need for metal springs. This reduces parts and weight while keeping operation squeak free, providing an infinitely adjustable, turnkey solution for maintaining optimal mainsail shape. Construction is hardcoat-anodized 6061-T6 aluminum, making them light and strong. Tubing and end fittings are threaded together eliminating fasteners and dissimilar metals to reduce corrosion.

Harken Vang-Masters are designed to be easy to install. Options available are external purchase systems which feature Harken hardware exclusively. They come pre-measured, spliced and finished with line specifically-selected for the application.

Harken distribution makes the vangs easy to obtain, while offering fast turnaround on spare parts and technical service.

Vang-Masters are available in eight standard sizes for boats 5-17 m (18-56 ft). Stainless steel mast and boom fitting and custom lengths are also available. Contact Harken for a price and lead time.



Purchase systems are available for each Vang-Master size with 4:1 or 6:1 mechanical advantage in single- or double-ended configurations.



© Steve Jost



Part No.	Description	Pin center length (closed)		Pin center length (open)		Stroke		Weight		Pin Ø		Jaw width		Maximum return force	
		in	mm	in	mm	in	mm	lb	kg	in	mm	in	mm	lb	kg
VM13240	Vang-Master 1	32	813	40	1016	8	203	2.75	1.25	3/8	10	1/4	6	350	159
VM24353	Vang-Master 2	43	1092	53	1346	10	254	3.4	1.54	3/8	10	1/4	6	350	159
VM33444	Vang-Master 3	34	864	44	1118	10	254	4.35	1.97	1/2	12.7	1/4	6	500	227
VM44656	Vang-Master 4	46	1168	56	1422	10	254	5.5	2.49	1/2	12.7	1/2	12	500	227
VM54860	Vang-Master 5	48	1219	60	1524	12	305	8.3	3.76	1/2	12.7	1/2	12	800	363
VM66274	Vang-Master 6	62	1575	74	1880	12	305	10	4.54	5/8	15.9	5/8	16	800	363
VM76274	Vang-Master 7	62	1575	74	1880	12	305	12.9	5.85	5/8	15.9	5/8	16	1500	680
VM87385	Vang-Master 8	73	1854	85	2159	12	305	14.6	6.62	5/8	15.9	5/8	16	1500	680

Ordering Vang-Master

Standard Vang-Master rigid vangs are available for boats with vang fittings on the boom and mastbase. If your boat is not equipped with vang fittings, or if fitting width or pin diameter will not fit jaw and pin sizes listed in the chart on previous page, contact Harken Tech Services for information on a custom vang.

Determine Vang Size

Vang-Master sizes are based on boat sailplan and PCLC /PCLO dimensions (PCLC= distance between the center of unit mounting pins at mast and boom with unit completely closed. PCLO=distance between the center of unit mounting pins with unit completely open.)

For PCLC, measure distance between hole centers with the boom at an attitude below which you never want it to go.

For PCLO, measure the distance between these holes with the boom as high as you would ever want it to go.

Select the correct unit size using from the "Typical Boat Length" Chart

Select the stroke size that fits your range from the "Pin Length/Stroke" Chart

Typical Boat Lengths:

VM1 & VM2: 5.5 - 7.9 m (18' - 26')
 VM3 & VM4: 7.6 - 11 m (25' - 36')
 VM5 & VM6: 10.7 - 14 m (35' - 46')
 VM7 & VM8: 13.7 - 17.1 m (45' - 56')

Part Numbers

VM13240

Size
PCLC in inches
 (pin center length closed)

PCLO in inches
 (pin center length open)

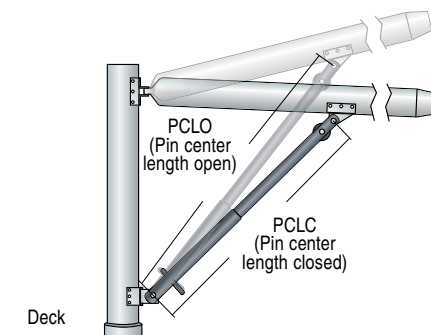

Stock Applications

Vang-Masters sized for production models are detailed below.

Please note, there may be rigging variation due to Class rule changes or equipment replacement.

VM-1

Moore 24
 Hot Foot 2
 Ultimate 20
 Santana 20

VM-2

J/80
 Cal 25
 Ultimate 24
 B-25
 Capri- 25
 J/24
 Merit 25
 M-24

VM-3

Cal 29
 Catalina 27
 Erickson 27
 Catalina 30
 J/27
 Olson 30
 Santana 3030

VM-4

Catalina 34
 Cal 28
 Cal 27
 Islander Bahama 30
 J/29
 J/30
 Evelyn 32
 J/105
 J/100
 J/133
 J/33
 Pearson 30
 Hunter 28
 Tartan 10
 Cal 31
 Ranger 33
 Pearson 34
 Sabre 30
 Hobbie 33
 Islander 36
 Antrim 27
 Soverel 33
 Flying Tiger F-10
 J/99
 Henderson 30
 Farr Mumm 30
 M-32

VM-5

Erickson 35
 Santana 35
 Hunter 34
 Hans Christian 33
 C & C 38
 Catalina 38
 Catalina 36
 J/35
 J/111
 J/40
 J/37
 J/109
 Express 37
 Tartan 35
 Valiant 42
 Peterson 44
 Benetau First 38
 Bristol 35

Grand Soleil 39
 Island Packet 35
 Hinckley Bermuda 40
 Hallberg Rassy 42
 Cabo Rico 38
 Passport 40
 Sabere 42
 Antrim 40
 Cf 40
 Farr 40
 Farr 400
 Kirby 25
 Summit King 40
 Farr Mumm 36
 Summit 35
 Soto 40
 Benetau First 36.7

VM-6

Catalina 400
 Catalina 42
 Cal 40
 Cal 39
 J/122
 J/46
 X- Yacht 45
 J/120
 X- Yacht 38
 Swan 44
 Swan 43
 Cabr Rico 42
 Passport 42
 Moody 46
 Dufour 45
 Hylas 42
 Cheoy Lee Offshore 48
 Bristol 47
 Wauquieux 46
 J/125
 Dk 46
 Sydney 40
 Benetau First 40.7
 J/121
 Jeanneau Sun Odyssey 410

VM-7

Catalina 47
 Santa Cruz 50
 Lidgard 45
 Morris 46
 Tp- 52
 X- Yacht 512
 Swan 48
 Swan 46
 Passport 54
 Columbia 50
 Dufour 520
 Hylas 54
 Andrews 56

VM-8

Jeanneau 57
 Santa Cruz 52
 Santa Cruz 70
 Andrews 70

Vang-Master Purchase Systems

Select Purchase System

Standard purchase systems are available for each Vang-Master size with 4:1 or 6:1 mechanical advantage in single- or double-ended configurations.

Systems are pre-measured, spliced and supplied with line specifically selected for the application.



Part No.	Description	Purchase	Includes	Use with
7500	4:1 Single-ended 40 mm Carbo	4:1	(1) 2655 fiddle, (1) 2658 fiddle w/Cam-Matic/becket, 6 mm line	VM1, VM2, VM3
7501	4:1 Double-ended 40 mm Carbo	4:1	(1) 2638 double, (3) 2636 single, 6 mm line	VM1, VM2, VM3
7502	6:1 Single-ended 40 mm Carbo	6:1	(1) 2640 triple, (1) 2613 triple w/Cam-Matic/becket, 6 mm line	VM1, VM2, VM3
7503	6:1 Double-ended 40 mm Carbo	6:1	(1) 2640 triple, (1) 2638 double, (2) 2636 single, 6 mm line	VM1, VM2, VM3
7504	4:1 Single-ended 57 mm Carbo	4:1	(1) 2621 fiddle, (1) 2676 fiddle w/Cam-Matic/becket, 8 mm line	VM4, VM5, VM6
7505	4:1 Double-ended 57 mm Carbo	4:1	(1) 2602 double, (3) 2600 single, 8 mm line	VM4, VM5, VM6
7506	6:1 Single-ended 57 mm Carbo	6:1	(1) 2604 triple, (1) 2630 triple w/Cam-Matic/becket, 8 mm line	VM4, VM5, VM6
7507	6:1 Double-ended 57 mm Carbo	6:1	(1) 2604 triple, (1) 2602 double, (2) 2600 single, 8 mm line	VM4, VM5, VM6
7508	4:1 Single-ended 75 mm Carbo	4:1	(1) 2690 fiddle, (1) 2697 fiddle w/Cam-Matic/becket, 10 mm line	VM7, VM8
7509	4:1 Double-ended 75 mm Carbo	4:1	(1) 2662 double, (3) 2660 single, 10 mm line	VM7, VM8
7510	6:1 Single-ended 75 mm Carbo	6:1	(1) 2664 triple, (1) 2686 triple w/Cam-Matic/becket, 10 mm line	VM7, VM8
7511	6:1 Double-ended 75 mm Carbo	6:1	(1) 2664 triple, (1) 2662 double, (2) 2660 single, 10 mm line	VM7, VM8

Vang-Master Accessories

Harken offers Vang-Master boom fittings, mast fittings and pumps to accompany the vang. The stainless steel fittings can be easily mounted, pivoting like a hinge to fit the mast. Sturdy hardware fits the boom appropriately for easy Vang-Master connection.

If Required: Select Mast And Boom Fittings – Sold Separately

Determine if a rounded or flat fitting will provide the most integral boom mount.

Use the stock applications chart (page 155) to match the Vang-Master unit you have selected with the corresponding boom and mast fittings.

Select the correct fasteners.

Use the chart information (below) or the fitting itself to determine the correct hole spacing and location before drilling.

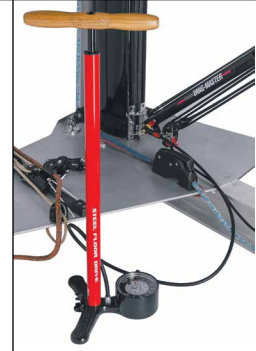

Lezyne stand-up and hand-held pumps fit naturally to the Vang-Master Schrader valve, helping adjust boom height and resistance level.

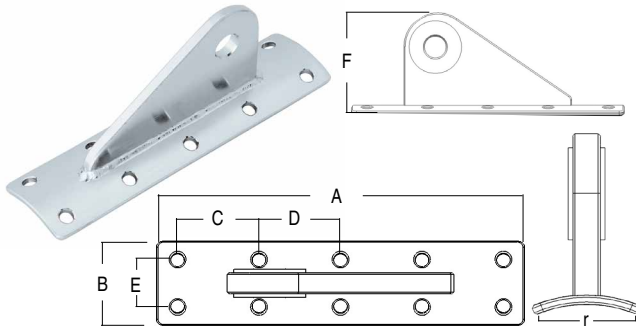

ROUNDED BASE BOOM FITTINGS

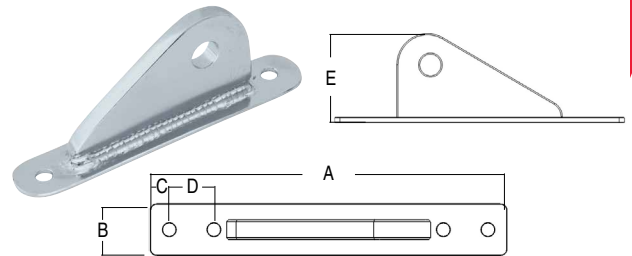

FLAT BASE BOOM FITTINGS

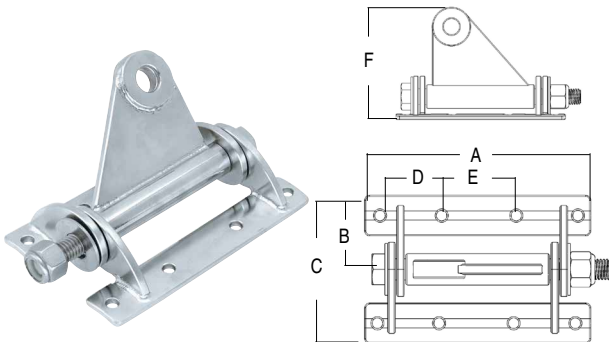

PIVOTING MAST FITTINGS



PUMPS

Part No.	Description	Fastener Size		No. of Fasteners	Pin Ø		Toggle Width		A	B	C	D	E	F	r
		in	mm		in	mm	in	mm							
Vang-Master Fittings															
VMB12	Rounded base boom fitting — units 1 & 2	1/4	6	8	3/8	9.5	1/4	6.35	5	1 1/2	1 3/8	1 1/4	3/4	1 3/8	1 3/4
VMB34	Rounded base boom fitting — units 3 & 4	1/4	6	10	1/2	12.7	1/4	6.35	6 1/2	1 5/8	1 7/16	—	1 1/8	2 1/8	1 3/4
VMB56	Rounded base boom fitting — units 5 & 6	1/4	6	10	1/2	12.7	3/8	12.7	6 1/2	1 5/8	1 7/16	—	1 1/8	2 1/4	1 3/4
VMBF12	Flat base boom fitting — units 1 & 2	3/16	5	2	3/8	9.5	1/4	6.35	4	3/4	3/8	—	1 3/8	—	—
VMBF34	Flat base boom fitting — units 3 & 4	1/4	6	4	1/2	12.7	1/4	6.35	7	1	3/8	7/8	2 1/8	—	—
VMBF56	Flat base boom fitting — units 5 & 6	1/4	6	4	1/2	12.7	3/8	9.5	7	1	3/8	7/8	2	—	—
VMM12	Pivoting mast fitting — units 1 & 2	1/4	6	3	3/8	9.5	1/4	6.35	4 1/4	7/8	2 5/8	1 3/4	—	2 1/4	—
VMM34	Pivoting mast fitting — units 3 & 4	1/4	6	4	1/2	12.7	1/4	6.35	4 3/4	1	3 1/2	1 3/8	1 1/4	2 7/8	—
VMM56	Pivoting mast fitting — units 5 & 6	1/4	6	4	1/2	12.7	1/2	12.7	5 1/2	1	3 5/8	1 1/2	1 7/8	3 1/2	—

Part No.	Description	oz	Weight		Height (closed)	
			g	in	mm	
Vang-Master Pumps						
VMP2	Vang-Master pump/hand pump/Aluminium — Black	5.3	150	11 4/5	300	
VMP3	Vang-Master pump/floor drive/Steel — Red	60	1700	25	635	



SIMRAD

HEADSAIL

HANDLING SYSTEMS

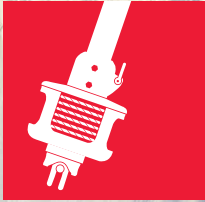

NEW FOR 2024



**Halyard restrainer —
160° angle**
SEE PAGE 191

Carbo Racing Foil

The engineering resins in these strong, lightweight head foils offer significant advancements over the weaker PVC materials used by other manufacturers. The low-friction twin headsail grooves are ultra-smooth, allowing hoists, douses, and headsail changes to be easily and efficiently executed. Impact resistance is unmatched, with far less foil damage from loaded spinnaker poles, especially in cold weather. Heat has little effect on stiffness.

Foils are UV protected and easy for the trimmer to see. For mast-up installation, simply uncoil the foil and snap onto the stay.

Aluminum Chafe Guard

An aluminum chafe guard keeps spinnaker sheets from damaging the foil during high-speed jibes. Testing shows this guard weighs the same as aramid fiber or composite, and is impervious to wear, unlike UHMW plastic tape which wears away quickly. A Harken chafe guard is included free with the purchase of a 7000, 7001, or 7002 kit.



Invictus, Jeanneau Sun Fast 3600, 11.25 m (36'10"), Daniel Andrieu design © Billy Black



Trim cap



Feeder for smooth hoists:
Funnel-shaped stainless feeder smoothly guides boltrope into headfoil for fast hoists.



Prefeeder: Hardcoat-anodized, PTFE-coated aluminum rollers spin freely on low-friction bushings.

Kit includes prefeeder.



7000
7001
7002

7003

Actual size
Unit 3

Unit 2

Unit 1

Unit 0

7000.30
7001.30
7002.30



7006

Part No.	Description	Max wire Ø		Max rod Ø		Extrusion length		Max headstay length		Spacer tube length		Extrusion weight		Full system weight*		Luff tape size**	
		in	mm	dash	mm	ft/in	m	ft/in	m	ft/in	m	lb/ft	kg/m	lb	kg	in	mm
7000.9M	Unit 0	1/4	6	-10	6.35	29' 6"	9	33' 6"	10.2	3' 3"	1	0.102	0.152	3.29	1.5	#5 (5/32)	4
7000.12M	Unit 0	1/4	6	-10	6.35	39' 4"	12	43' 4"	13.2	3' 3"	1	0.102	0.152	4.29	1.95	#5 (5/32)	4
7000.15M	Unit 0	1/4	6	-10	6.35	49' 2"	15	53' 2"	16.2	3' 3"	1	0.102	0.152	5.3	2.41	#5 (5/32)	4
7001.12M	Unit 1	5/16	8	-17	8.38	39' 4"	12	43' 4"	13.2	3' 3"	1	0.162	0.241	6.99	3.18	#6 (6/32)	5
7001.16M	Unit 1	5/16	8	-17	8.38	52' 6"	16	56' 5"	17.2	3' 3"	1	0.162	0.241	9.13	4.14	#6 (6/32)	5
7001.20M	Unit 1	5/16	8	-17	8.38	65' 7"	20	69' 7"	21.2	3' 3"	1	0.162	0.241	11.25	5.1	#6 (6/32)	5
7002.16M	Unit 2	3/8	10	-25	10.31	52' 6"	16	56' 5"	17.2	3' 3"	1	0.185	0.275	10.43	4.73	#6 (6/32)	5
7002.20M	Unit 2	3/8	10	-25	10.31	65' 7"	20	69' 7"	21.2	3' 3"	1	0.185	0.275	12.9	5.83	#6 (6/32)	5
7002.24M	Unit 2	3/8	10	-25	10.31	78' 9"	24	82' 9"	25.2	3' 3"	1	0.185	0.275	15.29	6.93	#6 (6/32)	5
7003.24M	Unit 3	7/16	11	-30	11.1	78' 9"	24	82' 9"	25.2	3' 3"	1	0.245	0.365	20.08	9.1	#6 (6/32);#7 (7/32)	5;6
7003.28M	Unit 3	7/16	11	-30	11.1	91' 10"	28	95' 9"	29.2	3' 3"	1	0.245	0.365	23.31	10.57	#6 (6/32);#7 (7/32)	5;6
7006	Carbo racing foil prefeeder													3 oz	85 g		
7000.30	Unit 0 chafe guard							3' 3"	1					2.5 oz	70 g		
7001.30	Unit 1 chafe guard							3' 3"	1					2.9 oz	82 g		
7002.30	Unit 2 chafe guard							3' 3"	1					3 oz	85 g		

*Weight without chafe guard. **Nominal dimensions only, actual luff tape dimensions are larger.

Small Boat Furling Components: Underdeck

Underdeck Furlers

Small Boat underdeck furling units are ideal for sportboats and daysailers from 4.8 - 9 m (16 - 30'). The drum is located beneath the deck, lowering the tack height for maximized sail area. The single through-deck ball joint provides a low-profile, nearly watertight system that aligns the spool to the headstay. Like all Small Boat furlers, the underdeck furler is for furling only, not reefing.

An optional hoistable ball bearing halyard swivel can be installed on the headstay so the sail can be raised or lowered without removing the headstay. See page 162.

Tack Adapter Tangs

Stainless steel tack adapter tangs are used to adapt clevis pin diameters on headstays to the standard clevis pin size that comes on the Harken unit. A third hole accepts lashing to adjust jib luff tension.



479
480
481
489

TACK ADAPTER TANGS



UNDERDECK FURLERS

Components (if ordering separately)

Upper swivel Part No.	Hoistable swivel Part No.	Drum Part No.	Upper swivel		Weight		Drum		Fits furler
			oz	g	oz	g	oz	g	
164	464	477L	2.6	74	2.9	82	24	680	477
207	465	493L	9.2	261	8.9	252	42.6	1201	493
478U	482	478L	15	431	16.8	477	81	2296	478

Furlers

Part No.	Description	Pin-to-pin length		Drum Ø		Line Ø				Jaw width		Max luff wire Ø		Clevis pin Ø		Weight		Maximum working load	
		in	mm	in	mm	in	mm	in	mm	in	mm	in	mm	in	mm	oz	g	lb	kg
477	Underdeck furler/small*	6 1/8	156	3 1/8	79	1/8	3	5/32	4	5/16	8	1/8	3	1/4	6.4	23.3	661	950	431
493	Underdeck furler/medium*	7 3/8	188	4	102	5/32	4	3/16	5	3/8	10	3/16	5	5/16	7.9	50.5	1433	2000	907
478	Underdeck furler/large*	10 7/32	260	5	127	3/16	5	1/4	6	1/2	12	1/4	6	7/16	11.1	96	2721	3000	1361

*Includes drum and upper swivel. Does not include hoistable swivel.

Tack Adapter Tangs

Part No.	Description	Tang-hole to tang-hole length		Upper pin Ø		Lower pin Ø		Max luff wire Ø		Clevis pin Ø		Weight		Maximum working load		Fits furler
		in	mm	in	mm	in	mm	in	mm	in	mm	oz	g	lb	kg	
479	4 mm tack adapter tang	1 1/2	38	5/16	8	7/16	11	5/32	4	5/16	7.9	5.2	147	3000	1361	478
480	5 mm tack adapter tang	1 1/2	38	3/8	10	7/16	11	3/16	5	3/8	9.5	5.2	147	3000	1361	478
481	6 mm tack adapter tang	1 1/2	38	7/16	11	7/16	11	1/4	6	7/16	11.1	5.2	147	3000	1361	478
489	8 mm tack adapter tang	1 3/8	35	5/16	8	5/16	8	5/32	4	5/16	7.9	3.2	91	2000	907	493

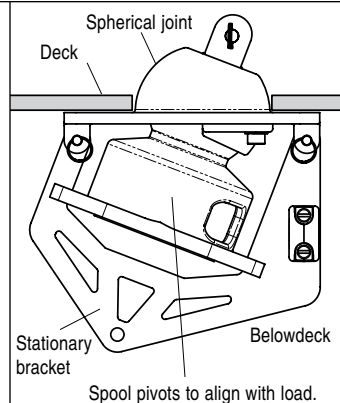

Turnbuckle eye on stationary bracket attaches to an underdeck chainplate.



Fairlead feeds line onto the spool.

Small Boat Furling Components: Halyard Swivels

All Harken Small Boat furling components can be purchased individually to mix and match. Systems require a drum and upper swivel. Some are also available as a complete kit. See page 163 for details.

Small Boat units are for furling only, not reefing.

Upper Halyard Swivels

Harken's high-performance 207HP swivel has needle roller thrust bearings that function smoothly under very high loads required at the top end of sportboat fleets, while matching the dimensions of our other 207 units—making an upgrade easy.

Standard upper halyard swivels feature multiple stacked races of ball bearings for low friction rotation under load. Delrin® ball bearings are used for low-load swivels. Torlon® bearings are used in standard and high-load swivels. Shackle or forked tang attachment options are available.

Hoistable Halyard Swivels

An optional hoistable ball bearing halyard swivel can be installed on the headstay so the sail can be raised or lowered without removing the headstay. Swivels are independent of the headstay, which allows the luff to be tensioned separately from the mast rake. Hoistable swivels work along with any standard Harken Small Boat furler.

Delrin is a registered trademark of E. I. du Pont de Nemours and Company or its affiliates. Torlon is a registered trademark of Solvay Advanced Polymers L.L.C.



Multiple stacked races of Delrin or Torlon ball bearings roll easily under load.

System with hoistable swivel: furlled headsail can be raised/lowered

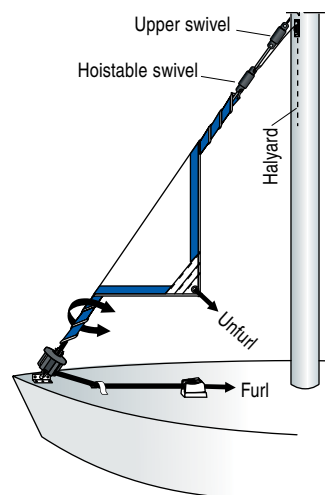

System without hoistable swivel: furlled headsail remains on stay

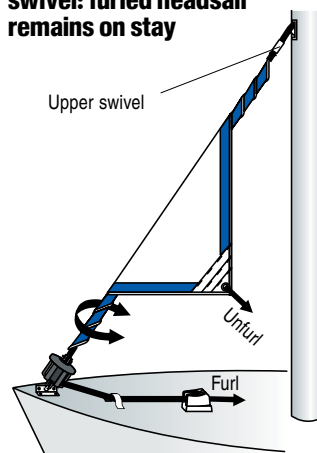

UPPER HALYARD SWIVELS

HOISTABLE SWIVELS

Part No.	Description	Pin-to-pin length		Max luff wire Ø		Clevis pin Ø		Weight		Maximum working load		Use with drum
		in	mm	in	mm	in	mm	oz	g	lb	kg	
Upper Halyard Swivels												
162	Low-load upper swivel	2 1/2	64	1/8	3	1/4	6.4	2.6	74	500	227	163
164	Standard upper swivel	2 1/2	64	1/8	3	1/4	6.4	2.6	74	950	431	165, 477L, 1134
207	High-load upper swivel	3 27/32	97.4	3/16	5	5/16	8	9.2	261	2000	907	208, 493L
207HP	High-performance upper swivel	3 27/32	97.4	3/16	5	5/16	8	6.8	193	2000	907	208, 493L
1878	Standard upper swivel/shackle	2 1/2	64	1/8	3	1/4	6.4	2.7	77	950	431	165, 477L, 1134
1880	High-load upper swivel/shackle	4	102	3/16	5	5/16	8	9.3	264	2000	907	208, 493L
Hoistable Halyard Swivels												
464	Halyard swivel/hole for 4 mm wire	4 3/16*	124*	5/32	4	5/32	4	2.9	82	810	367	435, 477L
465	Halyard swivel/hole for 5 mm wire	5 11/16*	144*	3/16	5	3/16	5	8.9	252	1190	540	208, 493L, 1134
482	Halyard swivel/hole for 6 mm wire	7 19/32*	193*	1/4	6	1/4	6.4	16.8	477	3000	1361	478L

*Shackle-to-shackle.

Small Boat Furling Components: Drums

All Harken Small Boat furling components can be purchased individually to mix and match. Systems require a drum and upper swivel. See page 162 for swivels. Some systems also available as a complete kit (see below).

Conventional Furling Drums

Harken Small Boat furling systems allow the trailerable cruising or dinghy sailor to set and furl the jib from the cockpit. Drums feature multiple stacked races of Delrin® or Torlon® bearings for smooth rotation under load. Small Boat units are for furling only, not reefing.

Continuous Line-Drive Furling Drum

The continuous line-drive furler is the perfect solution for high-performance skiffs and dinghies that use oversized jibs/gennakers and for staysails on larger boats. Unlike conventional furling drums, the low-profile line-driver never runs out of line, and can completely furl any sized sail. Offset holes in the drive sheave grip line securely, with the stripper arm and feeder working together to prevent line from jamming. The line guard adjusts in 90-degree increments to accommodate attachments to the boat.



Continuous line-drive furler features offset holes in the drive sheave to grip line securely.

Delrin is a registered trademark of E. I. du Pont de Nemours and Company or its affiliates.
Torlon is a registered trademark of Solvay Advanced Polymers L.L.C.



Part No.	Description	Pin-to-pin length		Drum Ø		Line Ø		Jaw width		Max luff wire Ø		Clevis pin Ø		Weight		Maximum working load		Upper swivel
		in	mm	in	mm	in	mm	in	mm	in	mm	in	mm	oz	g	lb	kg	
163	Low-load furler	2 1/2	64	2 7/8	73	5/32	4	5/16	8	1/8	3	1/4	6.4	5	142	500	227	162
165	Standard furler	2 1/2	64	2 7/8	73	5/32	4	5/16	8	1/8	3	1/4	6.4	5	142	950	431	164
208	High-load furler	4	102	4 3/16	106	1/4	6	3/8	10	3/16	5	5/16	7.9	13.6	386	2000	907	207
1134	Continuous line-drive furler	2 11/16	68	2 7/8	73	3/16	5	5/16	8	1/8	3	1/4	6.4	5.4	154	950	431	164

Small Boat Furling Kits

Harken Small Boat furling systems allow the trailerable cruising or dinghy sailor to set and furl the jib from the cockpit. Small Boat units are for furling only, not reefing.

All kits include the drum and upper swivel. The 483 kit also includes a hoistable halyard swivel. To order components separately, see swivels page 162, drums above.



Part No.	Description	Fits boats				Includes		Weight		Maximum working load		
		Monohull		Catamaran		Upper swivel	Hoistable swivel	Drum	oz	g	lb	kg
		ft	m	ft	m							
434	Low-load kit	Under 16	Under 4.9			162		163	7.6	215	500	227
435	Standard kit	16 - 20	4.9 - 6.1	hasta 18	hasta 5.5	164		165	7.6	215	950	431
436	High-load kit	20 - 25	6.1 - 7.6	18 - 23	5.5 - 7	207		208	22.8	646	2000	907
483	Standard kit/hoistable halyard	16 - 20	4.9 - 6.1	hasta 18	hasta 5.5	164	464	165	11.2	318	950	431

For additional specifications, see corresponding drum part number.



REFLEX FURLING

In a quickly-evolving environment, the Harken Reflex furling system is pushing free-flying sail furling forward. The patented Reflex system provides sailors confidence that their free-flying asymmetrical spinnakers, gennakers, and code sails will furl completely with speed and control. Pull the furling line and the compact drive unit reacts reflexively to rotate the torsion cable, immediately transferring torque to the head. The head swivel reacts instantly, spinning from top to bottom where perfect furls must start. Reflex furling requires much less luff tension to transfer torque than earlier technology, making it the perfect solution for today's budding cable-less code sail technology which requires about half the luff loads previously required. And whether the Reflex torsion cable is specified, or in applications where the head swivel and a tack plate are sewn directly to the sail, Reflex furling's quick release geometry allows crews to use multiple sails with the same bottom unit.



Three sizes:

- Unit 1 is rated at 1.5T MWL for boats to 11 m (36').
- Unit 2 is rated at 2.5T MWL for boats up to 14 m (45').
- Unit 3 is rated at 4.5T MWL for boats up to 17.4 m (58').



Complete even roll-up, tight wrap

- Low-friction ball bearing tack swivel allows the upper part of the sail to furl first.

Strong, lightweight

- Large diameter hardcoat-anodized 6061-T6 aluminum drive sheave.
- Torlon® ball bearings reduce friction, simplify maintenance.

Holds line securely

- Flexible polycarbonate alloy cowling allows rope to be easily fed into drive sheave without tools; keeps rope captive.
- Offset holes in drive sheave grip rope securely when furling.
- Stripper and feeder work together to prevent furling line from jamming.

Unit 1: 7351.10
Unit 2: 7352.10
Unit 3: 7353.10



Torlon is a registered trademark of Solvay Advanced Polymers L.L.C.

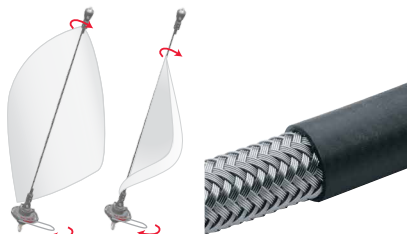

Code Zero sails

- The quick-release T-fitting allows the bottom unit to handle both code zero and asymmetric sails.
- The fixed tack terminal option is used when the torsion cable is inside the luff. A 2:1 soft attach is recommended for increased purchase and luff tension.

Immediate, smooth, controlled furling

- Reflex cable is more torsionally resistant to corkscrewing than the current breed of textile cable.
- All Reflex furlers use braided stainless steel wire filaments over braided textile core to transmit torque to the head swivel for faster furling. Unit 3 furlers use a Dyneema® core, which twists less and handles increased halyard loads without stretching, making them well suited for code zero applications by eliminating need for additional luff cable.
- Smooth polymer cable jacket protects sails against abrasion.

Easily change furled spinnakers

- Quick-release modular T-fitting allows single drive unit to handle multiple sails.
- Each sail has its own torsion cable. Head and tack swivels are permanently fitted to each sail.
- Rolled sail easily disconnects with the pull of one spring-loaded pin; new furled sail slides and locks into T-slot.



Padded cover



Lightweight, low-profile head swivel

- Integral thimble/terminal for torsion cable saves weight; no fork, eye, or pin connections.
- Compact design reduces weight aloft, maximizes luff length.
- Padded cover prevents damage to spars.

Reflex for retrofit

- Both head and tack swivels are available with fork and pin interfaces to allow sails with existing torsion cables finished with eyes to be easily adapted to Reflex furling. Contact Harken for details.

Reflex for cable-less Code sails

- Reflex head swivels and tack plates with integral T-fittings can be sewn directly to today's cable-less sails. The compact solution allows for longer luff lengths. Plus the same drive unit can service the whole inventory. Contact Harken for details.

Ordering Asymmetric Reflex Furling

Use for asymmetric free-flying spinnakers, cruising spinnakers, and gennakers that have a loose positive luff that is longer than the leech.

Boat Requirements

1. Spinnaker halyard
2. Attachment bail or adjustable tack fitting on a bowsprit or bow extension that allows the furler to clear the forestay and bow pulpit.

1. Determine System Size

Refer to "Typical Boat Length" and "Maximum Sail Area" on unit pages to select the correct size. Note: if you plan to use the system for code zero sails, the loads will be higher so the maximum boat length and sail area are smaller.

2. System Components

The Reflex furling system for asymmetric spinnakers includes all components necessary for one asymmetric spinnaker: one drive unit with snap shackle attachment, tack swivel, head swivel, torsion cable, set of cable clamps.

For each additional sail, order these components separately so you can easily switch furled sails using the quick-release T-slot: one tack swivel, head swivel, Reflex torsion cable, and set of cable clamps.

3. Determine Reflex Torsion Cable Length

Each system includes a length of torsion cable. To purchase the correct system including the right length of cable, determine your Full Hoist Dimension (FH). To do so, measure the distance between the sail attachment points at the top of the rig and the bow fitting or fully-extended bowsprit. Make sure the kit you select includes more cable than your FH measurement.

4. Attachment to Boat

The standard Reflex furling system for asymmetric spinnakers includes a threaded snap shackle adapter. To change to D shackle or soft-attach 2:1 adjuster see chart at right.

5. Ordering Furling Line

The Reflex furling system requires continuous furling line. Talk to your rigger about furling line construction using a structural cover over a nonstructural core. Note: have the rigger capture the aft block in the loop before splicing. The furling line loop can load into stanchion leads and drive unit after it is spliced.

Refer to chart below for line size and length. Double the loop length and add enough length for the overlap in the end-for-end splice.

Standard kit includes

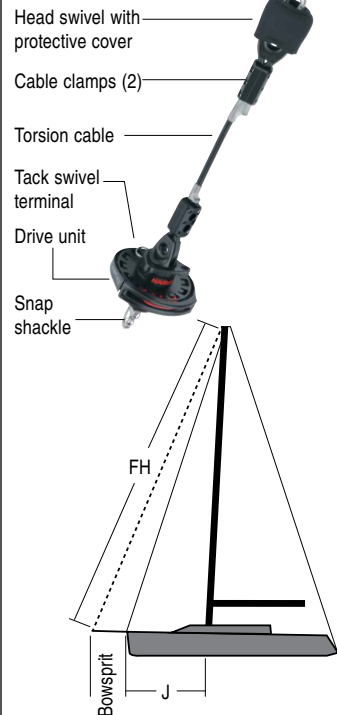

Alternative Attachments to Boat



Unit	High-resistance D shackle	Soft-attach 2:1 adapter
1	7351.21	7351.22
2	7352.21	7352.22
3	7353.21	7353.55

Furling Line

Unit	Line Ø		Length of loop (cruisers)	Length of loop (racers)
	in	mm		
1	1/4	6	Measure from furler to aft lead block in cockpit	Use J dimension plus length of bowsprit minus 60 cm (2')
2	5/16	8		
3	3/8	10		

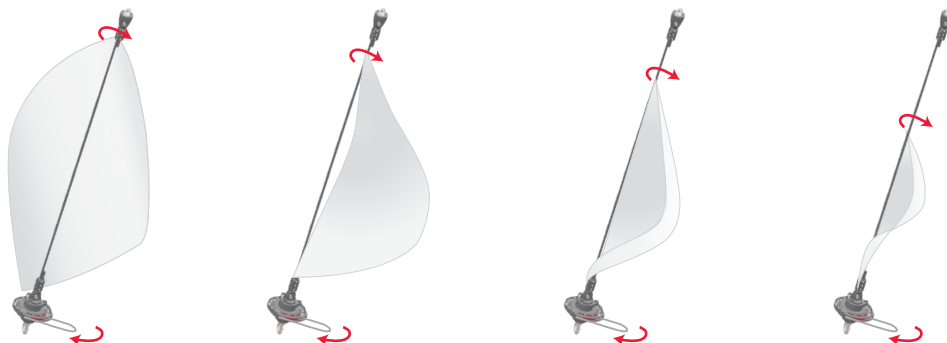

Reflex Furling System Unit 1

For Asymmetric Spinnakers

Typical Boat Length 7.5 - 11 m (25' - 36')

Maximum Sail Area 112 m² (1200 ft²)

Part No.	Description
7351.10.16M	Furling system with 16.15 m (53') cable*
7351.10.18M	Furling system with 18.29 m (60') cable*
7351.10.20M	Furling system with 20.12 m (66') cable*

Optional Parts	
7351.21	D-shackle threaded adapter
7351.22	2:1/soft attachment threaded adapter
7351.26	Reflex tack swivel terminal for extra sails
7351.28	Head swivel for extra sails
7351.37	Forked head swivel for retrofit torsion cable
7351.39	Reflex forked tack swivel terminal for retrofit torsion cable
7371.SPOOL	Reflex torsion cable (spool) 8 mm x 305 m (5/16" x 1000')
7371	Reflex torsion cable (ordered by the foot) for extra sails
7357	Cable clamp (set of 2) for extra sails
7356	Lead block kit**
7355	Outboard fairlead

*Includes: drive unit, head swivel, Reflex tack swivel terminal, snap shackle threaded adapter, Reflex torsion cable, and clamps. **Fairlead kit includes 2 fairleads, fairlead with cleat, and aft block.

Reflex Furling System Unit 2

For Asymmetric Spinnakers

Typical Boat Length 10 - 14 m (34' - 45')

Maximum Sail Area 168 m² (1800 ft²)

Part No.	Description
7352.10.20M	Furling system with 20.12 m (66') cable*
7352.10.23M	Furling system with 22.87 m (75') cable*
7352.10.25M	Furling system with 25 m (82') cable*

Optional Parts	
7352.21	D-shackle threaded adapter
7352.22	2:1/soft attachment threaded adapter
7352.26	Reflex tack swivel terminal for extra sails
7352.28	Head swivel for extra sails
7352.37	Forked head swivel for retrofit torsion cable
7352.39	Reflex forked tack swivel terminal for retrofit torsion cable
7372.SPOOL	Reflex torsion cable (spool) 10 mm x 305 m (3/8" x 1000')
7372	Reflex torsion cable (ordered by the foot) for extra sails
7358	Cable clamp (set of 2) for extra sails
7356	Lead block kit**
7355	Outboard fairlead

*Includes: drive unit, head swivel, Reflex tack swivel terminal, snap shackle threaded adapter, Reflex torsion cable, and clamps. **Fairlead kit includes 2 fairleads, fairlead with cleat, and aft block.



7351.10
7352.10

Optional Parts



7351.28
7352.28

7351.37
7352.37



7351.26
7352.26

7351.39
7352.39



7351.21
7352.21



7351.22
7352.22

7357
7358



7371
7372

7371.SPOOL
7372.SPOOL



7355

7356

Ordering Code Zero Reflex Furling

The Reflex torsion cable is not designed to accept luff loads associated with earlier code sail technology. It does, however, transfer the necessary torque to the head swivel for complete furling twice as effectively as any system we have tested—at far lower loads. If high luff loads will be encountered, combine a tension handling line with the Reflex torsion cable.

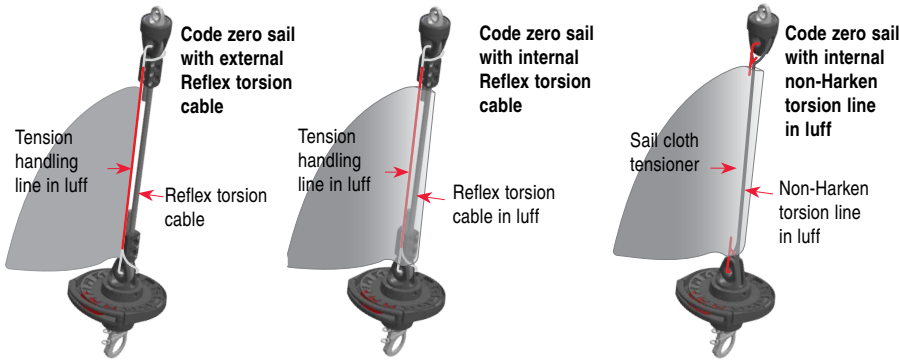

To furl a code zero sail that has a non-Harken torsion cable sewn into the luff, use either the thimbles or the eyes to secure to the head swivel and fixed tack terminal.



Optional Parts



Reflex Furling System Unit 1

For Code Zero Sails

Typical Boat Length 6.7 - 10 m (22' - 32')

Maximum Sail Area 60 m² (650 ft²)

Part No.	Description
7361.10	Code zero furling system*
Optional Parts	
7351.20	Snap shackle threaded adapter
7351.21	D-shackle threaded adapter
7351.27	Reflex fixed tack terminal for extra sails
7351.28	Head swivel for extra sails
7351.37	Forked head swivel for retrofit torsion cable
7351.38	Reflex forked tack terminal for retrofit torsion cable
7371.SPOOL**	Reflex torsion cable (spool) 8 mm x 305 m (5/16" x 1000')
7371**	Reflex torsion cable (ordered by the foot) for extra sails
7357**	Cable clamp (set of 2) for extra sails

*Includes: drive unit, head swivel, Reflex fixed tack terminal, 2:1 threaded adapter.

**Order Reflex torsion cable and clamp set for 7361.10 to improve furling.

Reflex Furling System Unit 2

For Code Zero Sails

Typical Boat Length 9 - 12 m (30' - 40')

Maximum Sail Area 84 m² (900 ft²)

Part No.	Description
7362.10	Code zero furling system*
Optional Parts	
7352.20	Snap shackle threaded adapter
7352.21	D-shackle threaded adapter
7352.27	Reflex fixed tack terminal for extra sails
7352.28	Head swivel for extra sails
7352.37	Forked head swivel for retrofit torsion cable
7352.38	Reflex forked tack terminal for retrofit torsion cable
7372.SPOOL**	Reflex torsion cable (spool) 10 mm x 305 m (3/8" x 1000')
7372**	Reflex torsion cable (ordered by the foot) for extra sails
7358**	Cable clamp (set of 2) for extra sails

*Includes: drive unit, head swivel, Reflex fixed tack terminal, 2:1 threaded adapter.

**Order Reflex torsion cable and clamp set for 7362.10 to improve furling.

Reflex Furling System Unit 3

For Asymmetric Spinnakers

Typical Monohull Length 13 - 17.7 m (44' - 58')

Typical Multihull Length 12 - 16.7 m (39' - 55')

Maximum Sail Area 223 m² (2400 ft²)

Part No.	Description
7353.10.22M	Furling system with 21.95 m (72') cable*
7353.10.26M	Furling system with 25.91 m (85') cable*
Optional Parts	
7353.21	D-shackle threaded adapter
7353.22	3:1/soft attachment threaded adapter
7353.26	Reflex tack swivel terminal for extra sails
7353.28	Head swivel for extra sails
7353.37	Forked head swivel for retrofit torsion cable
7353.39	Reflex forked tack swivel terminal for retrofit torsion cable
7373.SPOOL	Reflex torsion cable (spool) 13 mm x 305 m (33/64" x 1000')
7373	Reflex torsion cable (ordered by the foot) for extra sails
7367	Cable clamp (set of 2) for extra sails

*Includes: drive unit, head swivel, Reflex tack swivel terminal, snap shackle threaded adapter, Reflex torsion cable, and clamps.

Reflex Furling System Unit 3

For Code Zero Sails

Typical Monohull Length 12 - 16.5 m (39' - 54')

Typical Multihull Length 11 - 15 m (36' - 50')

Maximum Sail Area: Monohull 158 m² (1700 ft²); Multihull 139 m² (1500 ft²)

Part No.	Description
7363.10	Code zero furling system*
Optional Parts	
7353.20	Snap shackle threaded adapter
7353.21	D-shackle threaded adapter
7353.27	Reflex fixed tack terminal for extra sails
7353.28	Head swivel for extra sails
7353.37	Forked head swivel for retrofit torsion cable
7353.38	Reflex forked tack terminal for retrofit torsion cable
7373.SPOOL**	Reflex torsion cable (spool) 13 mm x 305 m (33/64" x 1000')
7373**	Reflex torsion cable (ordered by the foot) for extra sails
7367**	Cable clamp (set of 2) for extra sails

*Includes: drive unit, head swivel, Reflex fixed tack terminal, 3:1 threaded adapter.

**Order Reflex torsion cable and clamp set for 7363.10 to improve furling.

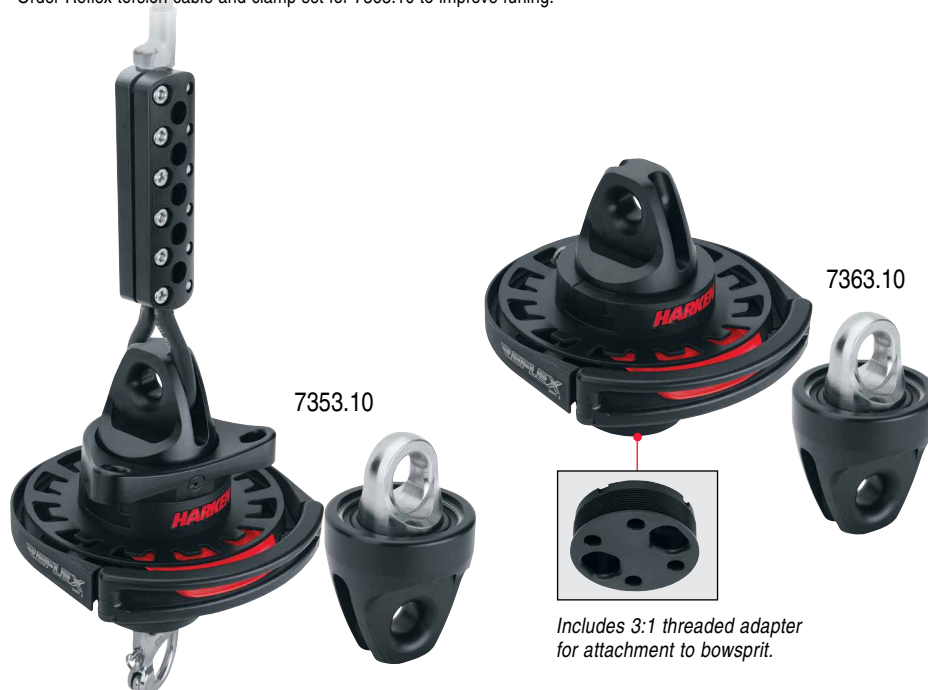

Optional Parts



7353.28

7353.37



7353.26

7353.27



7353.39

7353.38



7353.20

7353.21



7353.22

7367



7373

7373.SPOOL



Reflex Furling System Unit 1

For Cable-less Code Zero Sails

Typical Boat Length 6.7 - 10 m (22' - 32')

Maximum Sail Area 60 m² (650 ft²)

Part No.	Description
7351.10BASE	Drive unit
7351.22	2:1/soft attachment threaded adapter
7351.23	Reflex web-on tack terminal for cable-less code zero
7351.24	Web-on head swivel for cable-less code zero



7351.24
7352.24
7353.24

Reflex Furling System Unit 2

For Cable-less Code Zero Sails

Typical Boat Length 9 - 12 m (30' - 40')

Maximum Sail Area 84 m² (900 ft²)

Part No.	Description
7352.10BASE	Drive unit
7352.22	2:1/soft attachment threaded adapter
7352.23	Reflex web-on tack terminal for cable-less code zero
7352.24	Web-on head swivel for cable-less code zero



7351.23
7352.23
7353.23

Reflex Furling System Unit 3

For Cable-less Code Zero Sails

Typical Boat Length 12 - 16.5 m (39' - 54')

Typical Multihull Length 11 - 15 m (36' - 50')

Maximum Sail Area: Monohull 158 m² (1700 ft²); Multihull 139 m² (1500 ft²)

Part No.	Description
7353.10BASE	Drive unit
7353.22	3:1/soft attachment threaded adapter
7353.23	Reflex web-on tack terminal for cable-less code zero
7353.24	Web-on head swivel for cable-less code zero



7351.22
7352.22
7353.22



7351.10BASE
7352.10BASE
7353.10BASE





Ordering Jib Reefing & Furling

1. Choose Furler Type

The table below is based on sailing style and approximate boat size.
This table is only a guideline. Do not use it to determine unit size.
Size is based on the headstay and clevis pin diameters listed on unit pages.

Comparison Chart

	MKIV Racers/performance cruisers	MKIV Ocean Cruisers
Note: Typical boat lengths are listed as a guideline but are not the determining factor. Check with Harken if your length varies.		
Typical boat lengths	Unit 0: 6.5 – 9.1 m (22 – 30') Unit 1: 8.5 – 11 m (28 – 36') Unit 2: 10 – 14.2 m (35 – 46') Unit 3: 13.7 – 18.3 m (45 – 60') Unit 4: 19.8 – 24.4 m (65 – 80')	Unit 0: 6.5 – 9.1 m (22 – 30') Unit 1: 8.3 – 11 m (28 – 36') Unit 2: 10.6 – 14.2 m (35 – 46') Unit 3: 13.7 – 24.4 m (45 – 80')
Foils	Double-groove Air foil Stainless steel feeder	Single-groove round foil Stainless steel feeder
Halyard and tack swivel	Independent swivels for improved sail shape	Fixed
Drum	Removable split drum for racing	Fixed
Line	Included on Units 0, 1, 2	Included on Units 0, 1, 2

2. Determine Unit Size

Size is based on the headstay and clevis pin diameters listed on unit pages.
Choose between unit sizes when diameters are shared by considering stay length and typical boat size recommendations. Contact Harken if you have any questions.

3. Determine if Additional Foils Needed

Use the I and J measurements to determine the length of the headstay. If the existing headstay is longer than the standard length listed under Headstay Length on unit pages, order additional foils and connectors. In some cases one or two extra foils and connectors may be necessary.

4. Determine Toggle and Link Plate

Use short toggle for maximum luff length.

5. Choose Lead Block Kit and Accessories

Harken recommends equipping every furling system with a ratchet lead block kit. Other parts on the Furling Accessories page (185,191) include equipment for halyard management and racing hardware for faster sail changes. Order line for MKIV Ocean furlers.

6. Prepare Sail and Headstay

Have a luff tape added to your genoa. Match the sail length to the stay length minus the height of the halyard swivel and lower unit. See sizing information on page 184.

MKIV and MKIV Ocean furlers install over the existing turnbuckle. The turnbuckle is accessible for adjustment by raising the drum. See the MKIV & MKIV Ocean Toggle & Rigging Options on page 173 to determine toggle and rigging requirements. Some headstays will require cutting and shortening to fit Harken toggle. Sometimes only the lower threaded turnbuckle fitting needs changing. Check with a professional rigger on stay condition before reusing stay.

For all units, rod rigging requires a Harken rod adapter stud. It must be cut and coldheaded by an authorized rod service center.

7. Contact

If you have questions, please contact your dealer or Harken Technical Service.

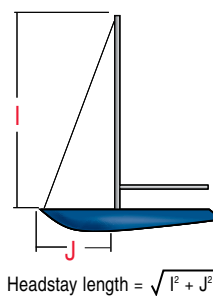
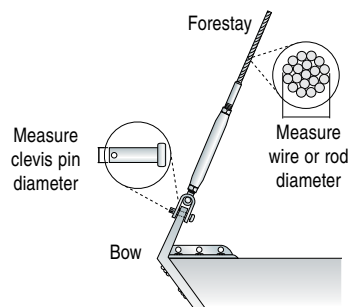

Toggle & Rigging Options

Use these rigger-supplied options to fit Harken toggles and leg kits shown below. Harken toggle and leg kit assemblies sold separately. See unit pages.

Model	Toggle		Clevis Pin Ø		Fits Unit	Furler Part No.
	Part No.	Description	in	mm		
MKIV	7311.20 1/2	Jaw/jaw	1/2	12.7	1	7411.10
	7311.21 1/2	Long link plate w/toggle	1/2	12.7		
	7311.21 5/8	Long link plate w/toggle	5/8	15.9	2	7412.10
	7312.20 5/8	Jaw/jaw	5/8	15.9		
	7312.21 5/8	Long link plate w/toggle	5/8	15.9	3	7413.10
	7312.21 3/4	Long link plate w/toggle	3/4	19.1		
	7413.20 3/4	Jaw/jaw w/short link plate	3/4	19.1	4	7414.10
	7413.20 7/8	Jaw/jaw w/short link plate	7/8	22.2		
	7313.21 3/4	Long link plate w/toggle	3/4	19.1	3	7413.10
	7313.21 7/8	Long link plate w/toggle	7/8	22.2		
7414.20 7/8	Jaw/jaw w/short link plate	7/8	22.2	4	7414.10	
7414.20 1	Jaw/jaw w/short link plate	1	25.4			
7414.20 1 1/8	Jaw/jaw w/short link plate	1 1/8	28.6			

MKIV Ocean	7311.20 1/2	Jaw/jaw	1/2	12.7	1	7511.10
	7311.21 1/2	Long link plate w/toggle	1/2	12.7		
	7311.21 5/8	Long link plate w/toggle	5/8	15.9	2	7512.10
	7312.20 5/8	Jaw/jaw	5/8	15.9		
	7312.21 5/8	Long link plate w/toggle	5/8	15.9	3	7513.10
	7312.21 3/4	Long link plate w/toggle	3/4	19.1		
	7413.20 3/4	Jaw/jaw w/short link plate	3/4	19.1	3	7513.10
	7413.20 7/8	Jaw/jaw w/short link plate	7/8	22.2		
	7513.20 1	Jaw/jaw w/short link plate	1	25.4	3	7513.10
	7513.20 1 1/8	Jaw/jaw w/short link plate	1 1/8	28.6		
	7313.21 3/4	Long link plate w/toggle	3/4	19.1	3	7513.10
	7313.21 7/8	Long link plate w/toggle	7/8	22.2		
	7513.21 1	Long link plate w/toggle	1	25.4	3	7513.10
	7513.21 1 1/8	Long link plate w/toggle	1 1/8	28.6		

MKIV / MKIV Ocean	7410.20 5/16	Eye/jaw (reversible)	5/16	7.9	0	7410.10/
	7410.20 3/8	Eye/jaw (reversible)	3/8	9.5		7510.10
	7410.20 7/16	Eye/jaw (reversible)	7/16	11.1		
	7411.20 1/2	Eye/jaw (reversible)	1/2	12.7	1	7411.10/ 7511.10
	7412.20 5/8	Eye/jaw (reversible)	5/8	15.9	2	7412.10/ 7512.10
	7311.20 5/8	Stud/jaw*	5/8	15.9	1	7411.10/ 7511.10
7312.20 3/4	Stud/jaw**	3/4	19.1	2	7412.10/ 7512.10	

*Thread Ø: 5/8-18 LH **Thread Ø: 3/4-16 LH

MKIV HYDRAULIC	741X.25 X/X	Hydraulic furling toggles	3/4 -2 7/16	19.1-61.9	3H - 8H	741X.15
	741X.26 X/X	Furling toggles and cylinders	3/4 -2 7/16	19.1-61.9		

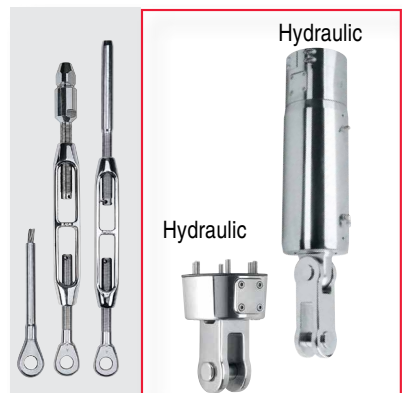
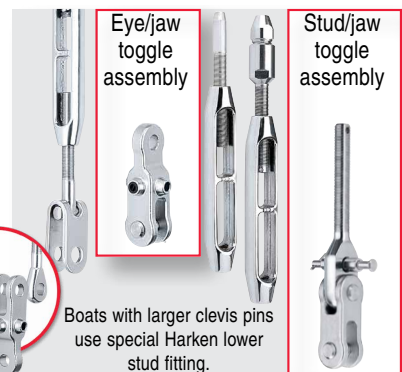
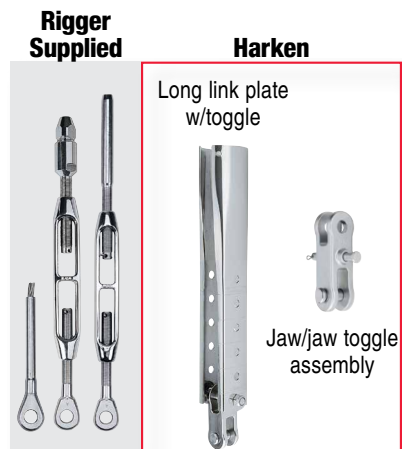



MKIV & MKIV OCEAN JIB REEFING & FURLING

MKIV furlers are some of the most preferred products in the Harken product line due to their high performance, reliability and ability to be reconfigured for racing. Now, Harken introduces MKIV Ocean offering MKIV quality, specifically configured for the cruising sailor. It is engineered with strength, longevity, ease of use, at the right price without extra features cruisers might not need.

For occasional racers, the MKIV line is engineered with ease, durability, and winning in mind. The split drum can be removed easily for use with racing sails, providing the longest possible luff length. The independent swivel supports optimal sail shape.



Low-friction efficiency for easy furling and reefing

- Multiple rows of Torlon® ball bearings in high-load areas minimize friction.
- Stacked bearing races evenly distribute radial and thrust loads; drum and halyard swivel turn freely under load.
- Foils rotate around headstay so headstay load is isolated from the furling unit for easy furling.
- Large inner spool diameter increases mechanical advantage for powerful reefing and furling.

Stands up to sun, salt, and time

- Aluminum line guard, torque tube, and swivels deep-saturation hardcoat-anodized, UV-stabilized for durability.
- Line guard polyurethane-coated for wear protection.
- Specially formulated low-stretch black line is abrasion and UV-resistant; standard on units 0, 1, 2.
- Aerodynamic (MKIV) and round (MKIV Ocean), foils handle extreme reefing loads.
- Triple-interlock foil joints withstand years of torque loading; foil connectors geometric shape interlocks with foil; secures with syringe-injected adhesive; screws provide final lock.

DO NOT use Harken equipment for human suspension unless product is specifically certified and labeled for such use.



	MKIV	MKIV Ocean
Typical boat size	6.5 - 24.4 m (22' - 80')	6.5 - 18.3 m (22' - 60')
Wire headstay diameter range	4 - 16 mm (5/32" - 5/8")	4 - 12 mm (5/32" - 1/2")
Rod headstay diameter range	-4 to -48 (4.37 - 14.3 mm)	-4 to -30 (4.37 - 14.3 mm)
Sailor	Racer (split drum can be removed)	Non-Racer/Cruising
Shape	Aerodynamic Foil	Round Foil
Swivel	Double at head and tack	Single at head and tack
Sizes	Five models (0 - 4)	Four models (0 - 3)



Improved sail shape and boat control

- Independent halyard and tack swivels furl sail center before head and tack for improved sail shape when reefed (MKIV).
- Both MKIV and MKIV Ocean have a light-weight aluminum halyard swivel saving weight aloft to reduce pitching and heeling.

Split drum removes easily for racing (MKIV)

- Line guard and spool remove easily for use with full-hoist sails.

Double and single-groove foils offer smooth sail handling

- Precision-extruded, double-groove (MKIV) and single-groove (MKIV Ocean) foils for smooth sail handling.
- Stainless steel feeder allows fast single-handed hoist and sail changes (MKIV).
- Black-anodized foils (MKIV) and clear-anodized foils (MKIV Ocean).

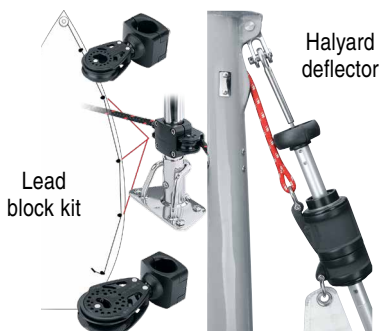
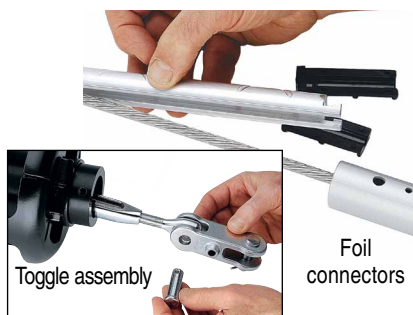

Designed for easy installation

- Small outside drum dimension fits narrow bows or belowdeck.
- C-shaped open connectors with low-friction plastic isolators easily slip onto headstay wire and into foil.
- Drum assembly fits over existing turnbuckle allowing easy length adjustment. Harken toggle assembly accepts standard turnbuckle using swage, rod, Norseman, or STA-LOK® terminals.
- Eye-jaw toggle flips for fork or tang chainplate installation.

Accessories

- Lead block kit: Easy-to-mount ball bearing blocks lead line aft; fit 25 mm (1") stanchions.
- Halyard deflector: Install above the foil to prevent halyards from wrapping around the foil when furling.

Easy to maintain

- Bearings require no lubrication or isolating seals.



- Stainless steel link plates raise the drum and fit over existing turnbuckle, resist scratches, and can be easily repolished.

MKIV Ocean Unit 0

Typical Boat Length 6.5 - 9.1 m (22' - 30')

Wire Ø (1 x 19 SS)	Rod Ø	Clevis pin Ø
4, 5, 6 mm (5/32", 3/16", 7/32")	-4, -6 (4.37, 5.03 mm)	7.9, 9.5, 11.1 mm (5/16", 3/8", 7/16")
Headstay Length Standard 11.77 m (38'7"); max 13.9 m (45'7")		
Part No.	Description	
7510.10	Furling system	
Toggle Assembly Required - sold separately		
7410.20 5/16	Eye/jaw reversible toggle assembly with 7.9 mm (5/16") clevis pin	
7410.20 3/8	Eye/jaw reversible toggle assembly with 9.5 mm (3/8") clevis pin	
7410.20 7/16	Eye/jaw reversible toggle assembly with 11.1 mm (7/16") clevis pin	
Optional Parts		
7510.30	Extra 2.13 m (7') luff foil extrusion	
7510.31	Extra 153 mm (6") connector with bushings	
7420 -4	-4 rod adaptor stud (thread Ø UNF 7/16")*	
7421 -6	-6 rod adaptor stud (thread Ø UNF 7/16")*	

*Use with conventional turnbuckle.

7510.30
7511.30



7510.31
7511.31

7420 -4
7421 -6
7422 -8
7423 -10
7424 -12



7410.20 5/16
7410.20 3/8
7410.20 7/16
7411.20 1/2



7311.20 1/2



7311.20 5/8

MKIV Ocean Unit 1

Typical Boat Length 8.3 - 11 m (28' - 36')

Wire Ø (1 x 19 SS)	Rod Ø	Clevis pin Ø
6, 7, 8 mm (1/4", 9/32", 5/16")	-8, -10, -12 (5.72, 6.35, 7.14 mm)	12.7, 15.9 mm (1/2", 5/8")
Headstay Length Standard 13.99 m (45'11"); max 16.12 m (52'11")		
Part No.	Description	
7511.10	Furling system	
Toggle Assembly Required - sold separately		
7411.20 1/2	Eye/jaw reversible toggle assembly with 12.7 mm (1/2") clevis pin	
7311.20 1/2	Jaw/jaw toggle assembly with 12.7 mm (1/2") clevis pin	
7311.20 5/8	Stud/jaw toggle assembly with 15.9 mm (5/8") clevis pin (thread Ø UNF 5/8" LH)	
7311.21 1/2	Long link plate with toggle assembly with 12.7 mm (1/2") clevis pin	
7311.21 5/8	Long link plate with toggle assembly with 15.9 mm (5/8") clevis pin	
Optional Parts		
7511.30	Extra 2.13 m (7') luff foil extrusion	
7511.31	Extra 178 mm (7") connector with bushings	
7422 -8	-8 rod adaptor stud (thread Ø UNF 1/2")*	
7423 -10	-10 rod adaptor stud (thread Ø UNF 1/2")*	
7424 -12	-12 rod adaptor stud (thread Ø UNF 5/8")*	

*Use with conventional turnbuckle.



7510.10
7511.10

7311.21 1/2
7311.21 5/8



Essence 33, 10.13 m, Hoek Design, Essence Yachts © Michel Hof/Essence Yachts photo

MKIV Ocean Unit 2

Typical Boat Length 10.6 - 14.2 m (35' - 46')

Wire Ø (1 x 19 SS)	Rod Ø	Clevis pin Ø
8, 10, 11 mm (5/16", 3/8", 7/16")	-12, -17, -22 (7.14, 8.38, 9.53 mm)	15.9, 19.1 mm (5/8", 3/4")
Headstay Length Standard 18.38 m (60'4"); max 20.51 m (67'4")		
Part No.	Description	
7512.10	Furling system	
Toggle Assembly Required - sold separately		
7412.20 5/8	Eye/jaw reversible toggle assembly with 15.9 mm (5/8") clevis pin	
7312.20 5/8	Jaw/jaw toggle assembly with 15.9 mm (5/8") clevis pin (thread Ø UNF 5/8" LH)	
7312.20 3/4	Stud/jaw toggle assembly with 19.1 mm (3/4") clevis pin (thread Ø UNF 3/4" LH)	
7312.21 5/8	Long link plate with toggle with 15.9 mm (5/8") clevis pin	
7312.21 3/4	Long link plate with toggle with 19.1 mm (3/4") clevis pin	
Optional Parts		
7512.30	Extra 2.13 m (7") luff foil extrusion	
7512.31	Extra 216 mm (8 1/2") connector with bushings	
7424 -12	-12 rod adaptor stud (thread Ø UNF 5/8")*	
7425 -17	-17 rod adaptor stud (thread Ø UNF 5/8")*	
7426 -22	-22 rod adaptor stud (thread Ø UNF 3/4")*	

*Use with conventional turnbuckle.

MKIV Ocean Unit 3

Typical Boat Length 13.7 - 24.4 m (45' - 80')

Wire Ø (1 x 19 SS)	Rod Ø	Clevis pin Ø
11, 12, 14, 16 mm (7/16", 1/2", 9/16", 5/8")	-22, -30, -40, -48 (9.53, 11.1, 12.7, 14.3 mm)	19.1, 22.2, 25.4, 28.6 mm (3/4", 7/8", 1", 1 1/8")
Headstay Length Standard 22.76 m (74'8"); max 27.03 m (88'8")		
Part No.	Description	
7513.10	Furling system*	
Toggle Assembly Required - sold separately		
7413.20 3/4	Jaw/jaw with short link plate with 19.1 mm (3/4") clevis pin	
7413.20 7/8	Jaw/jaw with short link plate with 22.2 mm (7/8") clevis pin	
7513.20 1	Jaw/Jaw with short link plate with 25.4 mm (1") clevis pin	
7513.20 1 1/8	Jaw/Jaw with short link plate with 28.6 mm (1 1/8") clevis pin	
7313.21 3/4	Long link plate with toggle with 19.1 mm (3/4") clevis pin	
7313.21 7/8	Long link plate with toggle with 22.2 mm (7/8") clevis pin	
7513.21 1	Long link plate with toggle assembly with 25.4 mm (1") clevis pin	
7513.21 1 1/8	Long link plate with toggle assembly with 28.6 mm (1 1/8") clevis pin	
Optional Parts		
7513.30	Extra 2.13 m (7") luff foil extrusion	
7513.31	Extra 254 mm (10") connector with bushings	
7426 -22	-22 rod adaptor stud (thread Ø UNF 3/4")**	
7427 -30	-30 rod adaptor stud (thread Ø UNF 7/8")**	
7428 -40	-40 rod adaptor stud (thread Ø UNF 1")**	
7429 -48	-48 rod adaptor stud (thread Ø UNF 1 1/8")**	

*Line not included. **Use with conventional turnbuckle.

7510.30
7511.30



7510.31
7511.31

7424 -12
7425 -17
7426 -22
7427 -30
7428 -40
7429 -48

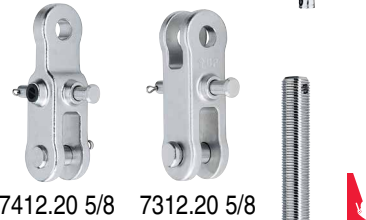

7412.20 5/8 7312.20 5/8



7413.20 3/4
7413.20 7/8
7513.20 1 7312.20 3/4



7512.10
7513.10

7513.21 1
7513.21 1 1/8

7312.21 5/8
7312.21 3/4
7313.21 3/4
7313.21 7/8



MKIV Unit 0

Typical Boat Length 6.5 - 9.1 m (22' - 30')

Wire Ø (1 x 19 SS)	Rod Ø	Clevis pin Ø
4, 5, 6 mm (5/32", 3/16", 7/32")	-4, -6 (4.37, 5.03 mm)	7.9, 9.5, 11.1 mm (5/16", 3/8", 7/16")
Headstay Length Standard 11.77 m (38'7"); max 13.9 m (45'7")		
Part No.	Description	
7410.10	Furling system	
Toggle Assembly Required - sold separately		
7410.20 5/16	Eye/jaw reversible toggle assembly with 7.9 mm (5/16") clevis pin	
7410.20 3/8	Eye/jaw reversible toggle assembly with 9.5 mm (3/8") clevis pin	
7410.20 7/16	Eye/jaw reversible toggle assembly with 11.1 mm (7/16") clevis pin	
Optional Parts		
7410.30	Extra 2.13 m (7") luff foil extrusion	
7410.31	Extra 165 mm (6 1/2") connector with bushings	
7420 -4	-4 rod adaptor stud (thread Ø UNF 7/16")*	
7421 -6	-6 rod adaptor stud (thread Ø UNF 7/16")*	

*Use with conventional turnbuckle.

MKIV Unit 1

Typical Boat Length 8.3 - 11 m (28' - 36')

Ø Cable (1 x 19 SS)	Ø Varilla	Ø Pasador
6, 7, 8 mm (1/4", 9/32", 5/16")	-8, -10, -12 (5.72, 6.35, 7.14 mm)	12.7, 15.9 mm (1/2", 5/8")
Headstay Length Standard 13.99 m (45'11"); max 16.12 m (52'11")		
Part No.	Description	
7411.10	Furling system	
Toggle Assembly Required - sold separately		
7411.20 1/2	Eye/jaw reversible toggle assembly with 12.7 mm (1/2") clevis pin	
7311.20 1/2	Jaw/jaw toggle assembly with 12.7 mm (1/2") clevis pin	
7311.20 5/8	Stud/jaw toggle assembly with 15.9 mm (5/8") clevis pin (thread Ø UNF 5/8" LH)	
7311.21 1/2	Long link plate with toggle assembly with 12.7 mm (1/2") clevis pin	
7311.21 5/8	Long link plate with toggle assembly with 15.9 mm (5/8") clevis pin	
Optional Parts		
7411.30	Extra 2.13 m (7") luff foil extrusion	
7411.31	Extra 178 mm (7") connector with bushings	
7422 -8	-8 rod adaptor stud (thread Ø UNF 1/2")*	
7423 -10	-10 rod adaptor stud (thread Ø UNF 1/2")*	
7424 -12	-12 rod adaptor stud (thread Ø UNF 5/8")*	

*Use with conventional turnbuckle.

7410.30
7411.30



7410.31
7411.31

7420 -4
7421 -6
7422 -8
7423 -10
7424 -12



7410.20 5/16
7410.20 3/8
7410.20 7/16
7411.20 1/2



7311.20 1/2



7311.20 5/8



7311.21 1/2
7311.21 5/8



MKIV Unit 2

Typical Boat Length 10.6 - 14.2 m (35' - 46')

Wire Ø (1 x 19 SS)	Rod Ø	Clevis pin Ø
8, 10 mm (5/16", 3/8")	-12, -17, -22 (7.14, 8.38, 9.53 mm)	15.9, 19.1 mm (5/8", 3/4")

Headstay Length Standard 18.38 m (60'4"); max 20.51 m (67'4")

Part No.	Description
7412.10	Furling system

Toggle Assembly Required - sold separately

7412.20 5/8	Eye/jaw reversible toggle assembly with 15.9 mm (5/8") clevis pin
7312.20 5/8	Jaw/jaw toggle assembly with 15.9 mm (5/8") clevis pin (thread Ø UNF 5/8" LH)
7312.20 3/4	Stud/jaw toggle assembly with 19.1 mm (3/4") clevis pin (thread Ø UNF 3/4" LH)
7312.21 5/8	Long link plate with toggle with 15.9 mm (5/8") clevis pin
7312.21 3/4	Long link plate with toggle with 19.1 mm (3/4") clevis pin

Optional Parts

7412.30	Extra 2.13 m (7') luff foil extrusion
7412.31	Extra 229 mm (9") connector with bushings
7424 -12	-12 rod adaptor stud (thread Ø UNF 5/8")*
7425 -17	-17 rod adaptor stud (thread Ø UNF 5/8")*
7426 -22	-22 rod adaptor stud (thread Ø UNF 3/4")*

*Use with conventional turnbuckle.

MKIV Unit 3

Typical Boat Length 13.7 - 18.3 m (45' - 60')

Wire Ø (1 x 19 SS)	Rod Ø	Clevis pin Ø
11, 12 mm (7/16", 1/2")	-22, -30 (9.53, 11.1 mm)	19.1, 22.2 mm (3/4", 7/8")

Headstay Length Standard 22.76 m (74'8"); max 24.89 m (81'8")

Part No.	Description
7413.10	Furling system*

Toggle Assembly Required - sold separately

7413.20 3/4	Jaw/jaw with short link plate with 19.1 mm (3/4") clevis pin
7413.20 7/8	Jaw/jaw with short link plate with 22.2 mm (7/8") clevis pin
7313.21 3/4	Long link plate with toggle with 19.1 mm (3/4") clevis pin
7313.21 7/8	Long link plate with toggle with 22.2 mm (7/8") clevis pin

Optional Parts

7413.30	Extra 2.13 m (7') luff foil extrusion
7413.31	Extra 248 mm (9 3/4") connector with bushings
7426 -22	-22 rod adaptor stud (thread Ø UNF 3/4")**
7427 -30	-30 rod adaptor stud (thread Ø UNF 7/8")**

*Line not included. **Use with conventional turnbuckle.

MKIV Unit 4

Typical Boat Length 19.8 - 24.4 m (65' - 80')

Wire Ø (1 x 19 SS)	Rod Ø	Clevis pin Ø
12, 14, 16 mm (1/2", 9/16", 5/8")	-30, -40, -48 (11.1, 12.7, 14.3 mm)	22.2, 25.4, 28.6 mm (7/8", 1", 1 1/8")

Headstay Length Standard 22.88 m (75'1"); max 27.15 m (89'1")

Part No.	Description
7414.10	Furling system*

Toggle Assembly Required - sold separately

7414.20 7/8	Jaw/jaw with short link plate with 22.2 mm (7/8") clevis pin
7414.20 1	Jaw/jaw with short link plate with 25.4 mm (1") clevis pin
7414.20 1 1/8	Jaw/jaw with short link plate with 28.57 mm (1 1/8") clevis pin

Optional Parts

7414.30	Extra 2.13 m (7') luff foil extrusion
7414.31	Extra 270 mm (10 3/4") connector with bushings
7427 -30	-30 rod adaptor stud (thread Ø UNF 7/8")**
7428 -40	-40 rod adaptor stud (thread Ø UNF 1")**
7429 -48	-48 rod adaptor stud (thread Ø UNF 1 1/8")**

*Line not included. **Use with conventional turnbuckle.

7412.30
7413.30
7414.30



7412.31
7413.31
7414.31



7424 -12
7425 -17
7427 -30
7428 -40
7429 -48



7412.20 5/8



7312.20 5/8



7312.20 3/4

7413.20 3/4
7413.20 7/8
7414.20 7/8
7414.20 1
7414.20 1 1/8



7312.21 5/8
7312.21 3/4
7313.21 3/4
7313.21 7/8





© Medora Media / Doug Wake

MKIV UNDERDECK JIB REEFING & FURLING

Harken's MKIV Underdeck Jib Reefing & Furling line is the perfect solution for sailors who want an aerodynamic system with a minimal amount of equipment above deck. The under-deck furler provides a low-friction, clean layout solution that minimizes windage, while uncluttering the bow for easy anchor access. Offered in four sizes for boats from 6.7 – 18.3 m (22' – 60').



Unit 1
Unit 2
Unit 3

Unit 0

Foil joints

Low-friction efficiency for easy furling and reefing

- Ball bearings between center hub and deck bearing, and main shaft reduce friction; drum and halyard swivel turn freely under load.
- Foils rotate around headstay so headstay load is isolated from the unit for easy furling.

Stand up to sun, salt, and time

- Units 1, 2, 3: Aluminum line guard, torque tube, and swivels hardcoat-anodized, UV-stabilized for durability. Line guard is polyurethane-coated for additional corrosion protection. Threaded height adjuster uses dissimilar metals (stainless steel and bronze) to prevent galling.
- Unit 0: One-piece integrated aluminum deck bearing and line guard hardcoat-anodized for durability and corrosion resistance.
- Aerodynamic, clear-anodized aluminum Air foils handle extreme reefing loads.
- Triple-interlock foil joints withstand years of torque loading: foil connector's geometric shape interlocks with foil; secures with syringe-injected adhesive; screws provide final lock.

DO NOT use Harken equipment for human suspension unless product is specifically certified and labeled for such use.

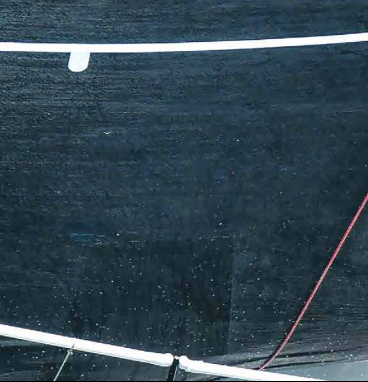

Improved sail shape and boat control

- Independent halyard and tack swivels furl sail center before head and tack for improved sail shape when reefed.
- Lightweight aluminum halyard swivel saves weight aloft to reduce pitching and heeling.
- Tack sits at deck level, lowering the tack height for maximized sail area.
- The torque tube houses a full-length turnbuckle for optimal mast rake and tension adjustment.
- Units 1, 2, 3: High-strength universal joints articulate, allowing ample headstay sag when sailing downwind.
- Unit 0: Articulating ball joint eliminates universal joint to reduce weight, simplify maintenance.

Fast hoists, douses, reefs, and sail changes

- Precision-extruded, double-groove Air foils for smooth sail handling and fast sail changes.
- Stainless steel feeder allows fast singlehanded hoist and sail changes.

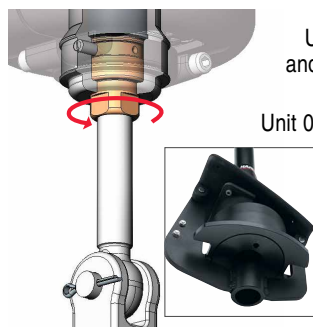

Designed for easy installation

- Units 1, 2, 3: Self-locking threaded height adjuster for correct fit between chainplate and deck.
- Unit 0: Does not require height adjuster; furler and headstay independent of each other allowing flexible installation options.
- Torque tube fits over existing turnbuckle allowing easy length adjustment. Hub assembly toggle accepts standard turnbuckle using swage, rod, Norseman, or STA-LOK® terminals.

Belowdeck drum fits narrow bows



- C-shaped open connectors with low-friction plastic isolators easily slip onto headstay wire and into foil.

Easy to maintain

- Bearings require no lubrication or isolating seals.
- Through-deck bearing into underdeck compartment provides a low profile, nearly watertight system.

MKIV Underdeck Unit 0

Typical Boat Length 6.7 - 9.1 m (22' - 30')

Wire Ø (1 x 19 SS)	Rod Ø	Clevis pin Ø
5, 6 mm (3/16", 7/32")	-4, -6 (4.37, 5.03 mm)	—
Headstay Length Standard 11.7 m (38'4"); max 13.8 m (45'4")		
Part No.	Description	
7410.11	Furling system	
Optional Parts		
7410.30	Extra 2.13 m (7') luff foil extrusion	
7410.31	Extra 165 mm (6 1/2") connector with bushings	



All MKIV Underdeck furlers feature a ball bearing halyard swivel.

MKIV Underdeck Unit 1

Typical Boat Length 8.3 - 11 m (28' - 36')

Wire Ø (1 x 19 SS)	Rod Ø	Clevis pin Ø
6, 7, 8 mm (1/4", 9/32", 5/16")	-8, -10 (5.72, 6.35 mm)	12.7 mm (1/2")
Headstay Length Standard 13.99 m (45'11"); max 16.12 m (52'11")		
Part No.	Description	
7411.11 1/2	Furling system with 12.7 mm (1/2") clevis pin	
Optional Parts		
7411.30	Extra 2.13 m (7') luff foil extrusion	
7411.31	Extra 178 mm (7") connector with bushings	



7410.30
7411.30

7410.31
7411.31

Dimensions

Unit	Part No.	A		B		C					
		Min in	Max mm	Min in	Max mm	Min in	Max mm	Min in	Max mm		
0	7410.11	6 7/8	175	5	30.4						
1	7411.11 1/2	10 5/8	270	15 5/8	397	5 1/2	140	4 5/8	117	9 5/8	244



7410.11

7411.11 1/2



J/122 © J/Boats



MKIV Underdeck Unit 2

Typical Boat Length 10.6 - 14.2 m (35' - 46')

Wire Ø (1 x 19 SS)	Rod Ø	Clevis pin Ø
8, 10 mm (5/16", 3/8")	-12, -17 (7.14, 8.38 mm)	15.9 mm (5/8")
Headstay Length Standard 18.38 m (60'4"); max 20.51 m (67'4")		
Part No.	Description	
7412.11 5/8	Furling system with 15.9 mm (5/8") clevis pin	
Optional Parts		
7412.30	Extra 2.13 m (7') luff foil extrusion	
7412.31	Extra 229 mm (9") connector with bushings	

MKIV Underdeck Unit 3

Typical Boat Length 13.7 - 18.3 m (45' - 60')

Ø Cable (1 x 19 SS)	Ø Varilla	Ø Pasador
11, 12 mm (7/16", 1/2")	-22, -30 (9.53, 11.1 mm)	19.1, 22.2 mm (3/4", 7/8")
Headstay Length Standard 22.88 m (75'1"); max 25.02 m (82'1")		
Part No.	Description	
7413.11 3/4	Furling system with 19.1 mm (3/4") clevis pin	
7413.11 7/8	Furling system with 22.2 mm (7/8") clevis pin	
Optional Parts		
7413.30	Extra 2.13 m (7') luff foil extrusion	
7413.31	Extra 248 mm (9 3/4") connector with bushings	

Dimensions

Unit	Part No.	A		B		C					
		Min in	Max mm	Min in	Max mm	Min in	Max mm				
2	7412.11 5/8	12 11/16	322	18 9/16	471	6 5/8	167	5 3/8	137	11 5/16	287
3	7413.11 3/4	16 1/8	410	23 5/8	600	8 3/16	208	6 7/8	175	14 3/8	365
3	7413.11 7/8	16 9/16	421	24 1/4	616	8 3/16	208	7 5/16	186	15	381

Francis Lee, 18.9 m (62'), Perry Silver, Robert H. Perry design, Northwest School of Boatbuilding © Boomer Depp



7412.30
7413.30



7412.31
7413.31

7412.11 5/8
7413.11 3/4
7413.11 7/8



Jib Reefing and Furling Dimensions

MKIV & MKIV Ocean Using Toggle*

System	Unit	Part No.	A		B		C		D		E	
			in	mm	in	mm	in	mm	in	mm	in	mm
MKIV	0	7410.10	3 3/4	96	5 7/8	150	1 7/8	47	5 1/2	140	2 5/8	66
	1	7411.10	4 3/4	120	7	178	2	51	6 5/8	167	3 1/16	78
	2	7412.10	5 5/8	143	9 1/8	231	2 9/16	66	8 3/16	208	3 13/16	97
	3	7413.10	7 5/16	186	11 5/8	296	3 3/8	86	9 3/4	247	4 3/4	121
4	7414.10	8 15/16	227		**		**	11 1/16	280	5 1/8	130	
MKIV Ocean	0	7510.10	3 3/4	96	5 7/8	150	1 7/8	47	5 1/2	140	2 5/8	66
	1	7511.10	4 3/4	120	7	178	2	51	6 5/8	167	3 1/16	78
	2	7512.10	5 5/8	143	9 1/8	231	2 9/16	66	8 3/16	208	3 13/16	97
3	7513.10	7 5/16	186	11 5/8	296	3 3/8	86	9 3/4	247	4 3/4	121	

System	Unit	Part No.	F		G		H		I									
			Max‡	Min	Max‡	Min	Max‡	Min	Max‡	Min								
MKIV	0	7410.10	41	1041	39 1/4	997	8 3/8	213	8	203	7 5/16	186	7	175	2 5/16	59	2	51
	1	7411.10	46 1/4	1175	42 1/4	1073	12	305	9 3/4	247	11	280	8 3/4	222	5	129	2 7/8	71
	2	7412.10	51 3/4	1314	46 3/4	1187	15 1/8	384	12 1/16	306	13 15/16	348	10 7/8	276	6 7/16	164	3 3/8	85
	3	7413.10	50 5/8	1286			18 7/16	467			16 5/8	420			7 3/8	188		
4	7414.10	55 5/16	1405			**	**	20	509					8 5/8	220			
MKIV Ocean	0	7510.10	41	1041	39 1/4	997	8 3/8	213	8	203	7 5/16	186	7	175	2 5/16	59	2	51
	1	7511.10	46 1/4	1175	42 1/4	1073	12	305	9 3/4	247	11	280	8 3/4	222	5	129	2 7/8	71
	2	7512.10	51 3/4	1314	46 3/4	1187	15 1/8	384	12 1/16	306	13 15/16	348	10 7/8	276	6 7/16	164	3 3/8	85
3	7513.10	50 5/8	1286			18 7/16	467			16 5/8	420			7 3/8	188			

*See MKIV long link plate dimensions below. ** Soft-attachment tack, head, and halyard; distance varies.
‡Max refers to using stud jaw toggle. Use Min when adding long link plate dimensions.

MKIV Long Link Plate

*Note: If a long link plate is used, add the following dimensions to F, G, H, and I (based on whether plate is used full-length or shortened to one of five hole positions).		
Unit 1	12.7 mm (1/2") clevis pin	Add 337–168 mm (13 1/4"–6 5/8")
	15.9 mm (5/8") clevis pin	Add 286–111 mm (11 1/4"–4 3/8")
Unit 2	15.9 mm (5/8") clevis pin	Add 410–210 mm (16 1/8"–8 1/4")
	19.1 mm (3/4") clevis pin	Add 344–144 mm (13 9/16"–5 11/16")
Unit 3	19.1 mm (3/4") clevis pin	Add 497–271 mm (19 9/16"–10 11/16")
	22.2 mm (7/8") clevis pin	Add 505–279 mm (19 7/8"–11")

Foil Dimensions

System	Unit	Part No.	J		K		Foil length		Luff tape*	
			in	mm	in	mm	ft/in	m	in	mm
MKIV	0	7410.30	7/8	23	1 1/32	26	7'	2.13	#6 (6/32)	5
	1	7411.30	1	25	1 1/8	29	7'	2.13	#6 (6/32)	5
	2	7412.30	1 1/4	32	1 3/8	36	7'	2.13	#6 (6/32)	5
	3	7413.30	1 1/2	38	1 11/16	43	7'	2.13	#6 (6/32)	5
4	7414.30	1 3/4	44	1 27/32	47	7'	2.13	#6 (6/32)	5	
MKIV Ocean	0	7510.30	1 1/8	28			7'	2.13	#6 (6/32)	5
	1	7511.30	1 3/8	35			7'	2.13	#6 (6/32)	5
	2	7512.30	1 3/4	44			7'	2.13	#6 (6/32)	5
3	7513.30	2	50			7'	2.13	#6 (6/32)	5	

*Nominal dimensions only, actual luff tape dimensions are larger.

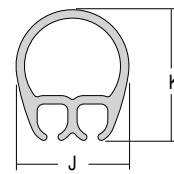

MKIV

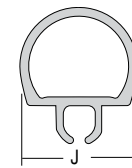

MKIV Ocean

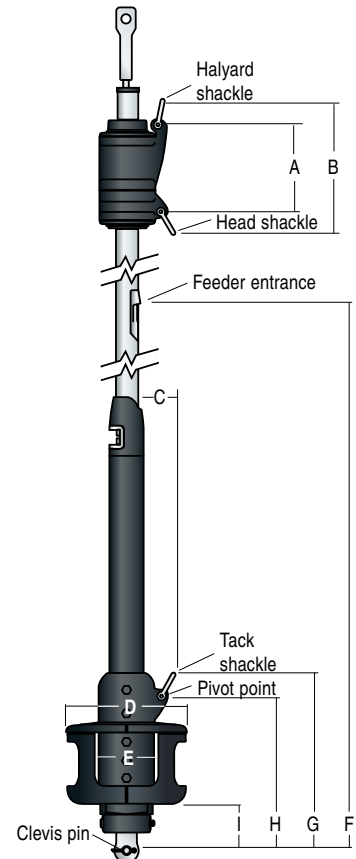

MKIV & MKIV Ocean



Cuba Libre, Twister 36, 11.2 m (36.75'), Weigel Anita Weigel, naval architect: Robert Roginski © Katarzyna Roginska

Furling Lead Blocks

Harken recommends equipping jib reefing and asymmetric/code zero furling systems with lead blocks for safe furling from the cockpit. Lightweight, UV-stabilized Carbo blocks run exclusively on ball bearings for fast trimming under any load. Furling leads are offered separately or in complete kits.

MKIV and MKIV Ocean Jib Reefing and Furling Leads

A 57 mm Carbo ratchet maintains tension on the line so the unit furls smoothly and easily. The outboard assembly allows the line to travel outside of the stanchions, keeping the sidedecks clear. Inboard block assemblies are available for the bow pulpit, to handle two lines, for continuous line furlers, or for cutter-rigged boats with two furlers. Ball and socket bases align blocks for smooth leads aft.

Reflex Asymmetric and Code Zero Furling Leads

Two stanchion leads forward guide line outboard to keep sidedecks clear. A stanchion lead aft features a double Harken Cam-Matic for cleating continuous furling line. A Carbo T2 block with shockcord attaches aft of the double cam to keep line in place for easy access.

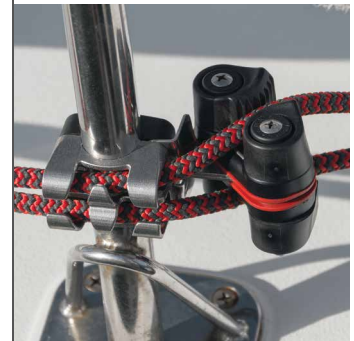

Outboard leads allow furling line to travel outboard of the stanchion to keep the sidedeck clear.



MKIV & MKIV OCEAN JIB REEFING & FURLING LEADS



REFLEX ASYMMETRIC & CODE ZERO FURLING LEADS

Part No.	Description	Sheave Ø		Weight		Max line Ø		Maximum working load		Use with
		in	mm	oz	g	in	mm	lb	kg	
MKIV & MKIV Ocean										
7401	40 mm Carbo lead block assembly	1 9/16	40	3.7	106	3/8	10	485	220	25 mm (1") stanchions
7402	57 mm Carbo ratchet lead block assembly	2 1/4	57	5.4	152	3/8	10	500	227	25 mm (1") stanchions
7403	29 mm outboard lead block assembly	1 1/8	29	3	85	3/8	10			25 mm (1") stanchions
7404	Lead block kit*			19.2	544	3/8	10			25 mm (1") stanchions
7405	40 mm Carbo stanchion mount double lead	1 9/16	40	5.6	159	3/8	10	485	220	25 mm (1") stanchions
7407	57 mm Carbo lead block	2 1/4	57	5.2	149	3/8	10	500	227	25 mm (1") stanchions
Reflex										
7355	Outboard fairlead			4.35	123	3/8	10			25 mm (1") stanchions
7356	Lead block kit**			26.54	751	3/8	10			25 mm (1") stanchions
7359	Outboard fairlead/double cam cleat			9.79	276	3/8	10			25 mm (1") stanchions
7360	57 mm T2 lead block/bungee	2 1/4	57	3.7	106	3/8	10	500	227	

*Kit includes 3 x 7403 / 1 x 7401 / 1 x 7402 / 1 cleat.

**Kit includes 2 x 7355 / 1 x 7359 / 1 x 7360.

MKIV HYDRAULIC JIB REEFING & FURLING

Powerful performance packed into a compact, slim profile makes our hydraulic headsail furlers the ultimate in push-button sail control. Perfect for cruisers and performance cruisers, these free-rolling systems fit wire sizes from 11 - 25 mm (7/16" - 1"); rod from -22 to -115 or equivalent fiber stays. Parts and service are available around the world.

Low-friction efficiency for easy furling and reefing

- Multiple rows of Torlon® ball bearings in high-load areas minimize friction.
- Stacked bearing races evenly distribute radial and thrust loads; halyard swivel turns freely under load.

Standard transmission reduces mechanical friction and pressure loss

- Engages/disengages the motor's powered and manual gear drive for efficient operation.
- Worm gear drive prevents backwinding; unloads hydraulic motor when reefed.

High-strength, lightweight

- Hardcoat-anodized, UV-stabilized aluminum torque tube, motor, and gear housing.
- Aerodynamic, clear-anodized aluminum Air foils handle extreme reefing loads; carbon fiber foils available on request.
- Triple-interlock foil joints withstand years of torque loading: foil connectors geometric shape interlocks with foil; secures with syringe-injected adhesive; screws provide final lock.

Carbon foil

Foil joints



Improved sail shape and boat control

- Independent halyard and tack swivels furl sail center before head and tack for improved sail shape when reefed.
- Lightweight aluminum halyard swivel saves weight aloft to reduce pitching and heeling.
- Unit 3 uses a hard shackle. Units 4 through 6 lashed on with Spectra® line; system evenly distributes loads.
- Lower unit's compact size brings sail's tack close to deck.



Fast hoists, douses, reefs, and sail changes

- Precision-extruded, double-groove Air foils for smooth sail handling and fast sail changes.
- Stainless steel feeder allows fast singlehanded hoist and sail changes.



Emergency manual operation in case of power loss

- Use supplied crank handle or cordless drill adapter, or use standard winch handle.

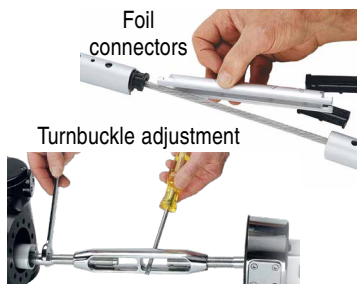

Designed for easy installation

- C-shaped open connectors with low-friction plastic isolators easily slip onto headstay wire and into foil.
- Lower unit fits over existing turnbuckle allowing easy length adjustment. Harken toggle assembly accepts standard turnbuckle using swage, rod, Norseman, or STA-LOK® terminals.
- Lower toggle assembly fixes at 90-degree intervals, accepts any chainplate direction.
- Motor has no case drain line for easier installation; fewer hoses.



Easy to maintain

- Bearings require no lubrication or isolating seals.
- Hardened steel gears and bearings in lower unit permanently lubricated in oil bath.
- Fewer parts easier to assemble and service.



Options

- A hydraulic cylinder installed below unit adjusts headstay, keeps luff tension constant. This prevents halyard and tack attachments from overloading when the headstay is adjusted.

Torlon is a registered trademark of Solvay Advanced Polymers L.L.C.
Spectra is a registered trademark of Honeywell International, Inc.
STA-LOK is a registered trademark of STA-LOK Terminals.

MKIV Hydraulic Jib Reefing & Furling



7413.30
7414.30

Contact Harken for availability of carbon foils



7413.31
7414.31S
7414.31L



7426 -22
7427 -30
7428 -40
7429 -48



7413.25 3/4
7413.25 7/8
7414.25 7/8
7414.25 1
7414.25 1 1/8



Manual operation switch and gear socket



Unit 3



Unit 4



Unit 3
Unit 4

Unit 3

Wire Ø (1 x 19 SS)	Rod Ø	Clevis pin Ø
11, 12 mm (7/16", 1/2")	-22, -30 (9.53, 11.1 mm)	19, 22.2 mm (3/4", 7/8")
Headstay Length Aluminum foil: standard 22.77 m (74'9"), max 24.91 m (81'9")		
Part No.	Description	
7413.15	Furling system with aluminum foils	
Toggle Assembly Required - sold separately		
7413.25 3/4	Toggle for 19 mm (3/4") clevis pin	
7413.25 7/8	Toggle for 22.2 mm (7/8") clevis pin	
Optional Parts		
7413.30	Extra 2.13 m (7') luff foil extrusion	
7413.31	Extra 248 mm (9 3/4") connector with bushings	
7426 -22	-22 rod adaptor stud (thread Ø UNF 3/4")	
7427 -30	-30 rod adaptor stud (thread Ø UNF 7/8")*	

Contact Harken to request quote and lead time. *Use with conventional turnbuckle.

Unit 4

Wire Ø (1 x 19 SS)	Rod Ø	Clevis pin Ø
12, 14, 16 mm (1/2", 9/16", 5/8")	-30, -40, -48 (11.1, 12.7, 14.3 mm)	22.2, 25.4, 28.6 mm (7/8", 1", 1 1/8")
Headstay Length Aluminum foil: standard 22.93 m (75'3"), max 29.33 m (96'3")		
Part No.	Description	
7414.15S	Furling system with aluminum foils and small bushings; fits -30, -40 rod, 12 mm (1/2") wire	
7414.15L	Furling system with aluminum foils and large bushings; fits -48 rod, 14, 16 mm (9/16", 5/8") wire	
Toggle Assembly Required - sold separately		
7414.25 7/8	Toggle for 22.2 mm (7/8") clevis pin	
7414.25 1	Toggle for 25.4 mm (1") clevis pin	
7414.25 1 1/8	Toggle for 28.6 mm (1 1/8") clevis pin	
Optional Parts		
7414.30	Extra 2.13 m (7') luff foil extrusion	
7414.31S	Extra 270 mm (10 3/4") connector with small bushings; fits -30, -40 rod, 12 mm (1/2") wire	
7414.31L	Extra 270 mm (10 3/4") connector with large bushings; fits -48 rod, 14, 16 mm (9/16", 5/8") wire	
7427 -30	-30 rod adaptor stud (thread Ø UNF 7/8")	
7428 -40	-40 rod adaptor stud (thread Ø UNF 1")	
7429 -48	-48 rod adaptor stud (thread Ø UNF 1 1/8")*	

Contact Harken to request quote and lead time. *Use with conventional turnbuckle.

MKIV Hydraulic Jib Reefing & Furling



7415.30
7416.30



7415.31S
7415.31M
7415.31L
7416.31S
7416.31M
7416.31L



Contact Harken for availability of carbon foils.



7429 -48



7415.25 1 1/8
7415.25 1 1/4
7415.25 X X/X
7416.25 1 1/4
7416.25 1 3/8
7416.25 1 9/16
7416.25 X X/X



Unit 5

Wire Ø (1 x 19 SS)	Rod Ø	Clevis pin Ø
16, 19, 22 mm (5/8", 3/4", 7/8")	-48, -60, -76‡ (14.3, 16.8, 17.9 mm)	28.6, 31.8 mm (1 1/8", 1 1/4")
Headstay Length	7415.15S aluminum foil: standard 23.8 m (78'), max 34.7 m (114'); 7415.15M and 7415.15L aluminum foil: standard 26.5 m (87'), max 34.7 m (114')	
Part No.	Description	
7415.15S	Furling system with aluminum foils and small bushings; fits -48, -60 rod, 16 mm (5/8") wire	
7415.15M	Furling system with aluminum foils and medium bushings; fits -76 rod	
7415.15L	Furling system with aluminum foils and large bushings; fits 19, 22 mm (3/4", 7/8") wire	
Toggle Assembly Required - sold separately		
7415.25 1 1/8	Toggle for 28.6 mm (1 1/8") clevis pin	
7415.25 1 1/4	Toggle for 31.8 mm (1 1/4") clevis pin	
7415.25 X X/X*	Toggle for all other clevis pin sizes (customer supplied dimensions)	
Optional Parts		
7415.30	Extra 2.74 m (9') aluminum foil extrusion	
7415.31S	Extra 305 mm (12") connector with small bushings; fits -48, -60 rod, 16 mm (5/8") wire	
7415.31M	Extra 305 mm (12") connector with medium bushings; fits -76 rod	
7415.31L	Extra 305 mm (12") connector with large bushings; fits 19, 22 mm (3/4", 7/8") wire	
7429 -48	-48 rod adaptor stud (thread Ø UNF 1 1/8")**	

Contact Harken to request quote and lead time. ‡Continuous rod only. If rod is sectional, order Unit 6.
*Specify rigging dimensions when ordering. **Use with conventional turnbuckle.

Unit 6

Wire Ø (1 x 19 SS)	Rod Ø	Clevis pin Ø
22, 25 mm (7/8", 1")	-76, -91, -115 (17.9, 19.5, 22.2 mm)	31.8, 34.9, 39.7 mm (1 1/4", 1 3/8", 1 9/16")
Headstay Length	Aluminum foil: standard 28.8 m (94'6"), max 38.8 m (127'6")	
Part No.	Description	
7416.15S	Furling system with aluminum foils and small bushings; fits -76 rod	
7416.15M	Furling system with aluminum foils and medium bushings; fits -91 rod	
7416.15L	Furling system with aluminum foils and large bushings; fits -115 rod, 22, 25 mm (7/8", 1") wire	
Toggle Assembly Required - sold separately		
7416.25 1 1/4	Toggle for 31.8 mm (1 1/4") clevis pin	
7416.25 1 3/8	Toggle for 34.9 mm (1 3/8") clevis pin	
7416.25 1 9/16	Toggle for 39.7 mm (1 9/16") clevis pin	
7416.25 X X/X*	Toggle for all other clevis pin sizes (customer supplied dimensions)	
Optional Parts		
7416.30	Extra 3.35 m (11') aluminum foil extrusion	
7416.31S	Extra 330 mm (13") connector with small bushings; fits -76 rod	
7416.31M	Extra 330 mm (13") connector with medium bushings; fits -91 rod	
7416.31L	Extra 330 mm (13") connector with large bushings; fits -115 rod, 22, 25 mm (7/8", 1") wire	

Contact Harken to request quote and lead time. *Specify rigging dimensions when ordering.



Unit 4
Unit 5
Unit 6

Hydraulic Furling Dimensions

Unit	Part No.	A		B		C		D*		E**			
		in	mm	in	mm	in	mm	in	mm	in	mm	Max	Min
3	7413.15	7 5/16	186	12	300	8 1/4	209	3 1/4	80	47 9/16	1209	47	1194
4	7414.15S/L	8 15/16	227	14 1/4	360	8 7/8	225	4 1/2	115	55 1/2	1409	54 3/8	1381
5	7415.15S/M/L	10 1/2	267	17	430	10 3/8	264	5	120	63 1/2	1613	62 13/16	1596
6	7416.15S/M/L	12 1/2	314	20 1/2	520	11 3/16	285	6 5/16	160	67 3/8	1711	66 1/16	1679

*From boltrope

**If hydraulic cylinder is used, dimensions E through I will increase according to cylinder length and settings. See cylinder length addition chart. See installation manual for detailed cylinder dimension information.

Unit	Part No.	F**		G**		H**							
		Max	Min	Max	Min	Max	Min	Max	Min				
3	7413.15	32 7/8	836	32 5/16	821	18 7/8	480	18 1/2	470	16 11/16	424	16 1/8	409
4	7414.15S/L	38 1/4	971	37 1/8	943	22 1/4	565	21 1/4	540	19 11/16	500	18 9/16	472
5	7415.15S/M/L	41 11/16	1059	41	1042	27 1/2	700	26 3/4	680	24 1/2	619	23 11/16	602
6	7416.15S/M/L	46 9/16	1183	45 1/4	1150	30 3/8	770	28 3/4	730	26 1/4	666	25	634

**If hydraulic cylinder is used, dimensions E through I will increase according to cylinder length and settings. See cylinder length addition chart. See installation manual for detailed cylinder dimension information.

Unit	Part No.	I**		J		K							
		Max	Min	Max	Min	Max	Min	Max	Min				
3	7413.15	5 3/16	132	4 5/8	118	2 9/16	65	2	51	11 9/16	293	6 7/8	174
4	7414.15S/L	6 5/16	160	5 3/16	132	3 3/4	95	2 5/8	66	13 7/8	353	7 3/8	188
5	7415.15S/M/L	7 1/4	185	6 5/8	168	4 5/16	109	3 5/8	92	15 13/16	402	9 1/8	232
6	7416.15S/M/L	8 9/16	218	7 1/4	185	5 7/16	139	4 3/16	106	18 7/16	469	9 13/16	249

**If hydraulic cylinder is used, dimensions E through I will increase according to cylinder length and settings. See cylinder length addition chart. See installation manual for detailed cylinder dimension information.

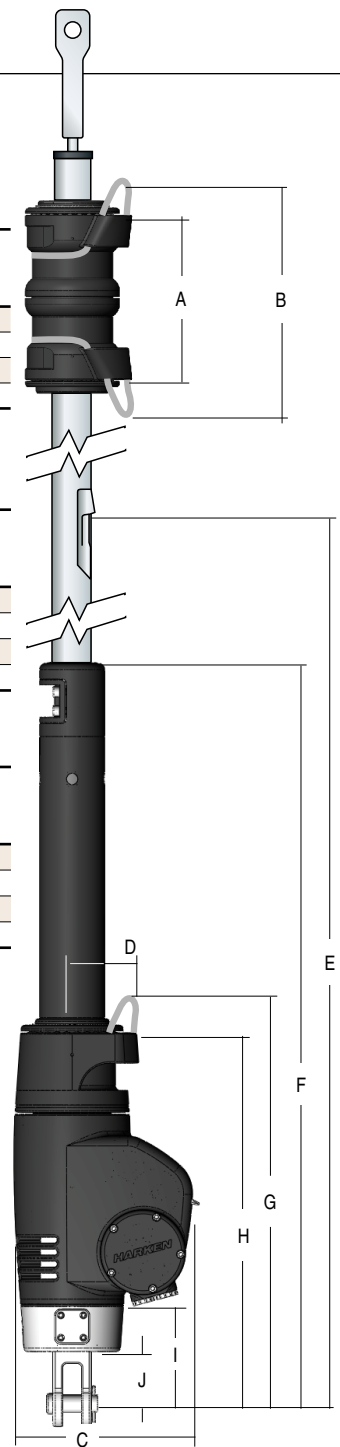

Cylinder Length Addition

Unit	Add min length		Add max length		Stroke length	
	in	mm	in	mm	in	mm
3	14 7/8	378	19	483	4	100
4	16 1/4	413	21 5/8	549	5	125
5	18 7/8	479	24 7/8	631	6	150
6	21 1/16	535	28 7/16	722	7	175

Foil Dimensions

Unit	Part No.	L		M		Foil length		Luff tape*	
		in	mm	in	mm	ft	m	in	mm
3	7413.30	1 1/2	38	1 11/16	43	7'	2.13	#6 (6/32)	5
4	7414.30	1 3/4	44	1 27/32	47	7'	2.13	#6 (6/32)	5
5	7415.30	2 13/32	61	2 5/8	63	9'	2.74	#6 (6/32), #7 (7/32)	5, 6
6	7416.30	3 3/16	82	3 9/32	83	11'	3.35	#6 (6/32), #7 (7/32)	5, 6

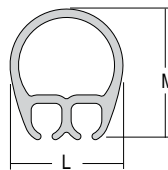

*Nominal dimensions only, actual luff tape dimensions are larger.

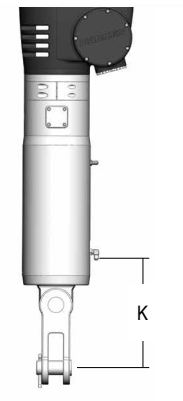

Furling Accessories

Harken offers halyard restrainers and halyard deflectors. The halyard restrainer installs on the mast near the top of the foil to keep the line against the mast, preventing halyard wrap when furling. The halyard deflector installs on the stay above the foil system, preventing the jib halyard (and additional halyards) from wrapping around the foil.

Also available are stanchion-mount bases for Carbo and Classic blocks, as well as prefeeders and snap shackles to facilitate fast sail changes.



947



7006



891



884

885

448



Antares 44i; 13.41 m (44'), Antares Yachts, naval architect: Ted Clements © Salwa Farah / Antares Yachts



061

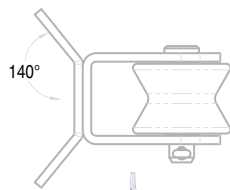

140°

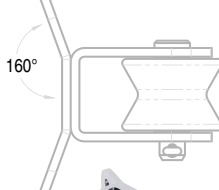

160°

7301, 7302
7303, 7304

7408

944
945

1113



7430



7431

Part No.	Description	Sheave Ø		Weight		Max line Ø		Maximum working load		Use with
		in	mm	oz	g	in	mm	lb	kg	
061	Stanchion mount base			2	57			350	159	22, 25 mm (7/8", 1") stanchions
448	Halyard lead block	1 1/2	38	2.1	60	3/8	10	300	136	0/1/2
884	Snap shackle			2.3	65			1500	680	MKIV 0/1
885	Snap shackle			5	141			2300	1040	MKIV 2
891	Small Boat furling snap shackle			2.3	65			950	431	163, 165, 1134, 434, 435, 483
944	Halyard restrainer — 140° angle**	15/16	25	3	85					0/1
945	Halyard restrainer — 140° angle**	1 1/4	31	6	170					2/3/3.25
1113	Halyard restrainer — 160° angle**	1 1/4	31	6	170					2/3/3.25
7301	Halyard deflector			1.6	45					MKIV and MKIV Ocean Unit 0
7302	Halyard deflector			2.4	68					MKIV and MKIV Ocean Unit 1
7303	Halyard deflector			4.8	136					MKIV and MKIV Ocean Unit 2
7304	Halyard deflector			8	227					MKIV and MKIV Ocean Unit 3
947	Prefeeder			1	28					All
7006	Carbo racing foil prefeeder			3	85					All
7408	Stanchion mount base			2	57			350	159	28.5 mm (1 1/8") stanchions
7430	Powered furling crank handle			7	198					Electric/hydraulic furling
7431	Powered furling drill adapter			2.5	71					Electric/hydraulic furling

*Stanchion mount base fits Classic Bullet, Big Bullet, 2.25", 57 mm Carbo single blocks, and ratchet blocks with swivel post. **#10 RH (5 mm) fasteners.



WINCHES

NEW FOR 2024

Air Winch 180
SEE PAGE 219



Air Captive
SEE PAGES 226



All-Chrome Radial Winches
SEE PAGE 197

Performa Winches
SEE PAGES 204-205



SnubbAir

It looks like a winch. It mounts like a winch. It cranks like a winch. It's not a winch.

First designed to solve a deck layout challenge unique to the J/70, the Harken SnubbAir might look like a smaller, more efficient version of the winch it replaces. But the product has so many potential applications it defies classification as a winch.

It could act more like a really large ratcheting foot, cheek block, or even a ratcheting line diverter in the pit. The SnubbAir provides lots of line-holding power even without a winch handle. That muscle could become very popular on an A Scow or a powered-up sport boat where the spinnakers can be more than a handful. Even better, you can just flip the sheet off the drum and jibe. If you need even more holding power, wrap the sheet around the SnubbAir twice or use a winch handle with the optional adapter.

SnubbAir comes with four integral threaded studs placed to precisely match the bolt pattern of the B8A winch on the J/70 deck. Start-to-finish, swapping out winches for SnubbAirs takes less than 10 minutes. All washers and Nylok® nuts required for mounting are included.



[Installation video](#)



Use the optional winch handle adapter to crank the SnubbAir like a winch.



The SnubbAir is smaller and lighter than the winch it replaces.



J/70 © J/Boats



1300



1301

Handle Adapter

Part No.	Description	Weight		Use with
		oz	g	
1301	Winch handle adapter	1.8	51	1300

SnubbAir

Part No.	Description	Drum Ø		Base Ø		Height		Weight		Fastener circle		Fasteners		Maximum holding load	
		in	mm	in	mm	in	mm	oz	g	in	mm	mm	lb	kg	
1300	SnubbAir	3.12	79.2	4.48	113.8	2.71	68.8	17.3	489	3.57	90.7	4 x M6	1000	454	

Nylok is a registered trademark of Nylok Corporation.



© Nick Woviotis / Skylla Filmworks LLC / Cruising World

RADIAL LINE WINCHES

Harken Radial Line winches have successfully balanced the need for a secure grip and line longevity with smooth, controlled easing while under load. Details sailors will appreciate: smaller winches that carry higher loads, stress-free seasonal maintenance, and one-person installation with easy upgrades to power. Nine sizes in multiple styles and finishes: aluminum, chrome, and bronze; 1-, 2-, and 3-speed self-tailing; manual, electric, or hydraulic drives.



Maximum holding power with minimum line wear

- Nonabrasive diagonal ribs on gripping surface hold line securely and reduce line wear; ribs shaped for each winch size and drum material.

Smooth, controlled easing

- Patented angle of ribs drives line wraps down when easing to keep them on area of drum that provides best control.

High-strength, lightweight

- Weight savings of 25 to 50 percent compared to Harken Classic winch line.
- High-strength composite roller bearings and bushings reduce friction under load.
- Load-carrying gears and pins are 17-4 PH stainless steel for strength, corrosion resistance.

DO NOT use Harken equipment for human suspension unless product is specifically certified and labeled for such use.



Adjustable stripper arm integrated into winch top for safer operation

- Stripper arm completely covers rotating winch top, preventing fingers and clothing from catching in moving parts.
- Adjusts to multiple positions after the winch is mounted to optimize line exit.
- Shaped to smoothly feed line in and out of self-tailing jaws.



Power-grip jaws shaped for easy line entry, optimum hold

- Upper jaw adjusts under line pressure; accepts a variety of line sizes.
- Teeth grip evenly with or without load.



Simple to install, easy maintenance

- Patented mounting system for fast, one-person installation without removing drum.
 - a. Snap off the skirt at the base of the winch.
 - b. Slide bolts through the slots in the winch base and snap the plastic skirt back on.
 - c. Place the stud bolts into the predrilled holes on the deck and tighten from belowdeck.
- Snap-fit design keeps bearings captive when drum is removed for maintenance.
- Easy to disassemble for service on deck; socket, washer, and screw-top snap-fit together for mistake-free reassembly.
- Composite roller bearings don't require lubrication.



Powered Options

- Electric: vertical-mount motors; horizontal-mount motors offered with right- or left-mount option.
- Hydraulic: vertical-mount motor.

Easy upgrade from manual to power

- Manual winches easily convert to powered using patented conversion method.
- No adapter plate required; identical stud pattern to mount winches of the same size without drilling new holes in deck.

- A predrilled hole in deck by builder simplifies manual-to-electric conversion; removable gaskets offered to seal holes until upgrade is made.

Energy-efficient motors accomplish more work per unit of electricity consumed

- Motors attach to central drive shaft and drive through winch gears for two-speed mechanical advantage.
- Low-power first gear for fast trimming; higher-power second gear for fine-tuning loaded sheets.

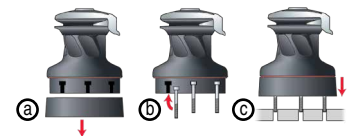

- Efficient design allows smaller motor size.

Manual override in case of power loss

- Harken locking handle inserted into an unloaded winch automatically disconnects motor gear for manual operation.



Aluminum & Chrome Radial Winches

About Radial winches: see feature pages at beginning of this section.



Series 15 and 20 winches use composite bushings to handle high loads in a small package.

WINCH Q&A

WHY DOES MY CHROME RADIAL LINE WINCH HAVE A DIFFERENT GRIP PATTERN THAN AN ALUMINUM RADIAL LINE WINCH?

Chrome has a more slippery finish than aluminum, so the ribs on chrome winches are spaced closer together to increase friction. This optimizes your grip for trimming as well as for easing the sail in a smooth, controlled manner.



ALUMINUM RADIAL



CHROME RADIAL

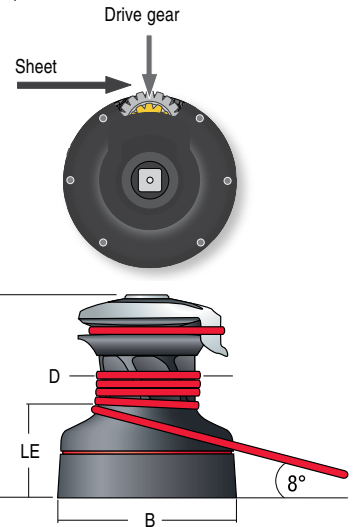

Part No.	Ø		Height (H)	Weight	Line entry height (LE)		Line Ø		Fastener circle	Fasteners (SH or HH)		Gear ratio			Power ratio									
	Drum (D)	Base (B)			in	mm	in	mm		Min	Max	in	mm	in	mm	1	2	3	1	2	3			
Aluminum Radial																								
15STA	2 7/8	73	4 3/4	120	5 1/2	139	4.6	2.1	2 1/4	58	1/4	6	3/8	10	3 15/16	100	5 x 1/4*	5 x 6	2.43		16.90			
20STA	2 7/8	73	5 3/8	137	5 13/16	148	5.3	2.4	2 3/8	61	1/4	6	1/2	12	4 3/8	110	5 x 1/4*	5 x 6	2.76		19.20			
35.2STA	3 1/8	80	5 7/8	149	6 11/16	170	7.9	3.6	3 1/8	79	5/16	8	1/2	12	4 7/8	123	5 x 1/4*	5 x 6	2.13	5.65	13.50	35.90		
40.2STA	3 1/8	80	6 3/16	157	6 7/8	175	8.4	3.8	3 1/4	82	5/16	8	1/2	12	4 7/8	123	5 x 1/4*	5 x 6	2.13	6.28	13.50	39.90		
46.2STA	3 7/8	100	7 1/4	184	7 15/16	201	11.5	5.2	3 9/16	90	5/16	8	9/16	14	5 7/8	150	5 x 5/16	5 x 8	2.30	9.17	11.70	46.50		
50.2STA	4 5/16	110	7 5/8	194	8 5/16	212	13.2	6	3 7/8	97	5/16	8	9/16	14	5 7/8	150	5 x 5/16	5 x 8	2.40	10.90	10.90	50.40		
60.2STA	4 3/4	120	9 5/16	236	9 11/16	246	22.5	10.2	4 9/16	116	5/16	8	5/8	16	8	204	6 x 5/16	6 x 8	4.80	14.40	20.30	61.00		
60.3STA	4 3/4	120	9 5/16	236	9 11/16	246	25.8	11.7	4 9/16	116	5/16	8	5/8	16	8	204	6 x 5/16	6 x 8	2.20	4.80	14.40	9.20	20.30	61.00
70.2STA	5 1/8	130	9 7/16	240	10 1/16	256	24.9	11.3	4 1/2	115	3/8	10	11/16	18	8 1/8	205	6 x 5/16	6 x 8	5.70	18.50	22.20	72.00		
70.3STA	5 1/8	130	9 7/16	240	10 1/16	256	28.3	12.8	4 1/2	115	3/8	10	11/16	18	8 1/8	205	6 x 5/16	6 x 8	2.30	5.70	18.50	9.00	22.20	72.00
80.2STA	6 7/8	175	11 5/16	287	12 9/16	320	46.8	21.2	6 7/16	164	3/8	10	11/16	18	9 3/16	233	8 x 3/8	8 x 10	9.94	32.12	28.85	93.24		
80.3STA	6 7/8	175	11 5/16	287	12 9/16	320	50.1	22.7	6 7/16	164	3/8	10	11/16	18	9 3/16	233	8 x 3/8	8 x 10	2.76	9.94	32.12	8.01	28.85	93.24
Chrome Radial																								
20STC	2 7/8	73	5 3/8	137	5 13/16	148	7.5	3.4	2 3/8	61	1/4	6	1/2	12	4 3/8	110	5 x 1/4*	5 x 6	2.76		19.20			
35.2STC	3 1/8	80	5 7/8	149	6 11/16	170	10.6	4.8	3 1/8	79	5/16	8	1/2	12	4 7/8	123	5 x 1/4*	5 x 6	2.13	5.65	13.50	35.90		
40.2STC	3 1/8	80	6 3/16	157	6 7/8	175	11.9	5.4	3 1/4	82	5/16	8	1/2	12	4 7/8	123	5 x 1/4*	5 x 6	2.13	6.28	13.50	39.90		
46.2STC	3 7/8	100	7 1/4	184	7 15/16	201	17.2	7.8	3 9/16	90	5/16	8	9/16	14	5 7/8	150	5 x 5/16	5 x 8	2.30	9.17	11.70	46.50		
50.2STC	4 5/16	110	7 5/8	194	8 5/16	212	20.3	9.2	3 7/8	97	5/16	8	9/16	14	5 7/8	150	5 x 5/16	5 x 8	2.40	10.90	10.90	50.40		
60.2STC	4 3/4	120	9 5/16	236	9 11/16	246	30.7	13.9	4 9/16	116	5/16	8	5/8	16	8	204	6 x 5/16	6 x 8	4.80	14.40	20.30	61.00		
60.3STC	4 3/4	120	9 5/16	236	9 11/16	246	34	15.4	4 9/16	116	5/16	8	5/8	16	8	204	6 x 5/16	6 x 8	2.20	4.80	14.40	9.20	20.30	61.00
70.2STC	5 1/8	130	9 7/16	240	10 1/16	256	33.3	15.1	4 1/2	115	3/8	10	11/16	18	8 1/8	205	6 x 5/16	6 x 8	5.70	18.50	22.20	72.00		
70.3STC	5 1/8	130	9 7/16	240	10 1/16	256	36.6	16.6	4 1/2	115	3/8	10	11/16	18	8 1/8	205	6 x 5/16	6 x 8	2.30	5.70	18.50	9.00	22.20	72.00
80.2STC	6 7/8	175	11 5/16	287	12 9/16	320	63.4	28.7	6 7/16	164	3/8	10	11/16	18	9 3/16	233	8 x 3/8	8 x 10	9.94	32.12	28.85	93.24		
80.3STC	6 7/8	175	11 5/16	287	12 9/16	320	66.7	30.2	6 7/16	164	3/8	10	11/16	18	9 3/16	233	8 x 3/8	8 x 10	2.76	9.94	32.12	8.01	28.85	93.24

*SH only

All-Chrome Radial Winches

About Radial winches: see feature pages at beginning of this section.



Polar Bear, 8.36 m (27.43'), Chantier des Ileaux, naval architect: Paolo Bua © Valerie Lanata

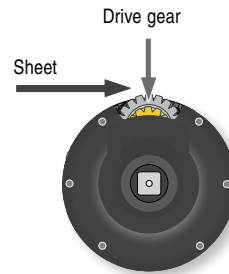
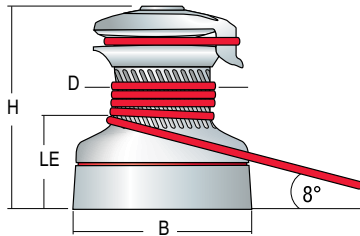

Part No.	Ø		Height (H)	Weight	Line entry height (LE)				Line Ø			Fastener circle		Fasteners (SH or HH)		Gear ratio			Power ratio					
	Drum (D)	Base (B)			in	mm	in	mm	in	mm	in	mm	in	mm	in	mm	1	2	3	1	2	3		
All-Chrome Radial: plain-top																								
20.2PTCCC	2 7/8	73	5 3/8	137	5 1/16	128	7.9	3.6	2 3/8	61			4 3/8	110	5 x 1/4*	5 x M6	1.00	2.76		6.95	19.20			
35.2PTCCC	3 1/8	80	5 7/8	149	5 13/16	148	11.5	5.2	3 1/8	79			4 7/8	123	5 x 1/4*	5 x M6	2.13	5.65		13.50	35.90			
40.2PTCCC	3 1/8	80	6 3/16	157	6	153	13.5	6.1	3 1/4	82			4 7/8	123	5 x 1/4*	5 x M6	2.13	6.28		13.50	39.90			
46.2PTCCC	3 7/8	100	7 1/4	184	7 1/16	179	21.4	9.7	3 9/16	90			5 7/8	150	5 x 5/16	5 x M8	2.30	9.17		11.70	46.50			
50.2PTCCC	4 5/16	110	7 5/8	194	7 1/2	190	25.6	11.6	3 7/8	97			5 7/8	150	5 x 5/16	5 x M8	2.40	10.90		10.90	50.40			
All-Chrome Radial: self-tailing																								
20STCCC	2 7/8	73	5 3/8	137	5 13/16	148	8.6	3.9	2 3/8	61	1/4	6	1/2	12	4 3/8	110	5 x 1/4*	5 x M6	2.76		19.20			
35.2STCCC	3 1/8	80	5 7/8	149	6 11/16	170	12.1	5.5	3 1/8	79	5/16	8	1/2	12	4 7/8	123	5 x 1/4*	5 x M6	2.13	5.65	13.50	35.90		
40.2STCCC	3 1/8	80	6 3/16	157	6 7/8	175	13.7	6.2	3 1/4	82	5/16	8	1/2	12	4 7/8	123	5 x 1/4*	5 x M6	2.13	6.28	13.50	39.90		
46.2STCCC	3 7/8	100	7 1/4	184	7 15/16	202	19.6	8.9	3 9/16	90	5/16	8	9/16	14	5 7/8	150	5 x 5/16	5 x M8	2.30	9.17	11.70	46.50		
50.2STCCC	4 5/16	110	7 5/8	194	8 5/16	212	22.9	10.4	3 7/8	97	5/16	8	9/16	14	5 7/8	150	5 x 5/16	5 x M8	2.40	10.90	10.90	50.40		
60.2STCCC	4 3/4	120	9 5/16	236	9 11/16	246	33.9	15.4	4 9/16	116	5/16	8	5/8	16	8	204	6 x 5/16	6 x M8	4.80	14.40	20.30	61.00		
60.3STCCC	4 3/4	120	9 5/16	236	9 3/8	253	37.3	16.9	4 9/16	116	5/16	8	5/8	16	8	204	6 x 5/16	6 x M8	2.20	4.80	14.40	9.20	20.30	61.00
70.2STCCC	5 1/8	130	9 7/16	240	10 1/16	256	36.8	16.7	4 1/2	115	3/8	10	11/16	18	8 1/8	205	6 x 5/16	6 x M8	5.70	18.50	22.20	72.00		
70.3STCCC	5 1/8	130	9 7/16	240	10 3/8	264	40.1	18.2	4 1/2	115	3/8	10	11/16	18	8 1/8	205	6 x 5/16	6 x M8	2.30	5.70	18.50	9.20	22.20	72.00
80.2STCCC	6 7/8	175	11 5/16	287	12 9/16	320	46.8	21.2	6 7/16	164	3/8	10	11/16	18	9 3/16	233	8 x 3/8	8 x M10	9.94	32.12	28.85	93.24		
80.3STCCC	6 7/8	175	11 5/16	287	12 7/8	327	50.1	22.7	6 7/16	164	3/8	10	11/16	18	9 3/16	233	8 x 3/8	8 x M10	2.76	9.94	32.12	8.01	28.85	93.24

*SH only. **FH only.

Bronze Radial Winches

About Radial winches: see feature pages at beginning of this section.

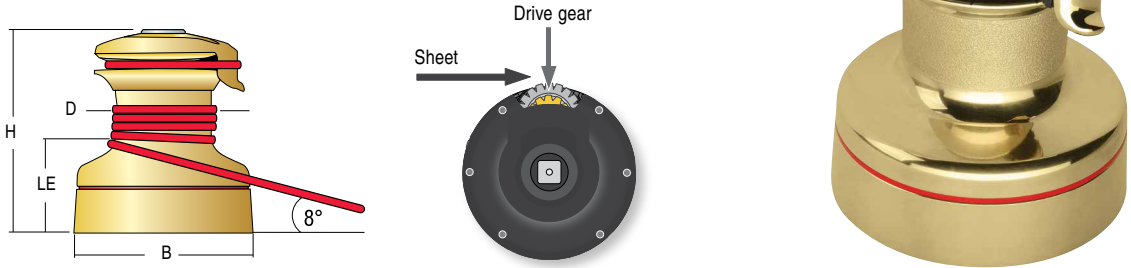

Part No.	Drum (D)		Base (B)		Height (H)		Weight		Line entry height (LE)		Line Ø		Fastener circle		Fasteners (SH or HH)		Gear ratio			Power ratio						
	in	mm	in	mm	in	mm	lb	kg	in	mm	in	mm	in	mm	in	mm	1	2	3	1	2	3				
Bronze Radial: plain-top																										
20.2PTBBB	2 7/8	73	5 3/8	137	5 1/16	128	7.9	3.6	2 3/8	61			4 3/8	110	5 x 1/4*	5 x M6	1	2.76		6.95	19.20					
35.2PTBBB	3 1/8	80	5 7/8	149	5 13/16	148	11.5	5.2	3 1/8	79			4 7/8	123	5 x 1/4*	5 x M6	2.13	5.65		13.50	35.90					
40.2PTBBB	3 1/8	80	6 3/16	157	6	153	13.5	6.1	3 1/4	82			4 7/8	123	5 x 1/4*	5 x M6	2.13	6.28		13.50	39.90					
46.2PTBBB	3 7/8	100	7 1/4	184	7 1/16	179	21.4	9.7	3 9/16	90			5 7/8	150	5 x 5/16	5 x M8	2.30	9.17		11.70	46.50					
50.2PTBBB	4 5/16	110	7 5/8	194	7 1/2	190	25.6	11.6	3 7/8	97			5 7/8	150	5 x 5/16	5 x M8	2.40	10.90		10.90	50.40					
Bronze Radial: self-tailing																										
20STBBB	2 7/8	73	5 3/8	137	5 13/16	148	8.6	3.9	2 3/8	61	1/4	6	1/2	12	4 3/8	110	5 x 1/4*	5 x M6	2.76			19.20				
35.2STBBB	3 1/8	80	5 7/8	149	6 11/16	170	12.1	5.5	3 1/8	79	5/16	8	1/2	12	4 7/8	123	5 x 1/4*	5 x M6	2.13	5.65		13.50	35.90			
40.2STBBB	3 1/8	80	6 3/16	157	6 7/8	175	13.7	6.2	3 1/4	82	5/16	8	1/2	12	4 7/8	123	5 x 1/4*	5 x M6	2.13	6.28		13.50	39.90			
46.2STBBB	3 7/8	100	7 1/4	184	7 15/16	202	19.6	8.9	3 9/16	90	5/16	8	9/16	14	5 7/8	150	5 x 5/16	5 x M8	2.30	9.17		11.70	46.50			
50.2STBBB	4 5/16	110	7 5/8	194	8 5/16	212	22.9	10.4	3 7/8	97	5/16	8	9/16	14	5 7/8	150	5 x 5/16	5 x M8	2.40	10.90		10.90	50.40			
60.2STBBB	4 3/4	120	9 5/16	236	9 11/16	246	33.9	15.4	4 9/16	116	5/16	8	5/8	16	8	204	6 x 5/16	6 x M8	4.80	14.40		20.30	61.00			
60.3STBBB	4 3/4	120	9 5/16	236	9 3/8	253	37.3	16.9	4 9/16	116	5/16	8	5/8	16	8	204	6 x 5/16	6 x M8	2.20	4.80	14.40	9.20	20.30	61.00		
70.2STBBB	5 1/8	130	9 7/16	240	10 1/16	256	36.8	16.7	4 1/2	115	3/8	10	11/16	18	8 1/8	205	6 x 5/16	6 x M8	5.70	18.50		22.20	72.00			
70.3STBBB	5 1/8	130	9 7/16	240	10 3/8	264	40.1	18.2	4 1/2	115	3/8	10	11/16	18	8 1/8	205	6 x 5/16	6 x M8	2.30	5.70	18.50	9.00	22.20	72.00		

*SH only. **FH only.

Electric & Hydraulic Motors

Harken now offers 48V motors to accommodate the increase in requests from boat builders are offering these electrical systems most often reflecting improvements in battery technology. These systems reduce wattage lost to electrical resistance across the run while also allowing for the use of smaller, lighter cables.

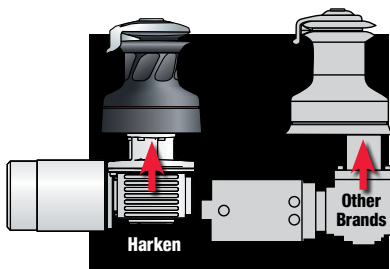

Harken electric and hydraulic motors attach to the central drive shaft and drive through the winch gears for a two-speed mechanical advantage — the low-power first gear for fast trimming, the higher-power second gear for fine-tuning loaded sheets. This results in reduced battery drain and a more efficient motor on the electric version. The energy-efficient hydraulic version is also smaller, reducing weight and cost.

Part Numbers

Specify power type, material, voltage, and motor configuration when ordering. Refer to manual self-tailing Radial winch pages for drum and power ratio specifications.

46.2STEC12H

- Winch size
- Number of speeds
- Self-tailing
- Power type
E = Electric
H = Hydraulic
- Material code
A = Aluminum
C = Chrome
CW = Chrome/white
CCC = All-chrome
BBB = Bronze
- Voltage
12 = 12V
24 = 24V
48 = 48V
- Motor configuration
Specify electric; hydraulic available in vertical only.
H = Horizontal
V = Vertical

Electric & Hydraulic Motors

Specify power type, material, voltage, and motor configuration when ordering. See part number explanation.
About Radial winches: see feature pages at beginning of this section.

Dimensions

Part No.	E		F		G		L		N		A		Weight		BBB/CCC		
	in	mm	in	mm	in	mm	in	mm	in	mm	lb	kg	lb	kg	lb	kg	
Electric																	
35.2STEh	1 3/4	43	6 1/8	155	8 7/8	227						29.3	13.3	32	14.5	33.5	15.2
40.2STEh	1 3/4	43	6 1/8	155	8 7/8	227						29.7	13.5	33.2	15.1	35	15.9
46.2STEh	1 3/4	43	6 1/8	155	8 7/8	227						32.8	14.9	38.5	17.5	41	18.6
46.2STEv							15 3/8	391	6 1/8	157		36.9	16.7	42.6	19.3	45	20.4
50.2STEh	2 3/4	69	7 1/8	181	9 5/8	244						37.1	16.8	44.2	20	46.7	21.2
50.2STEv							15 3/8	391	6 1/8	157		38.6	17.5	45.7	20.7	48.3	21.9
60.2STEh	2 3/4	69	7 1/8	181	9 5/8	244						46.4	21	54.5	24.7	57.8	26.2
60.2STEv							15 3/8	391	6 1/8	157		47.9	21.7	56.1	25.4	59.3	26.9
60.3STEh	2 3/4	69	7 1/8	181	9 5/8	244						49.7	22.5	57.8	26.2	61	27.7
60.3STEv							15 3/8	391	6 1/8	157		51.2	23.2	59.4	26.9	62.6	28.4
70.2STEh	2 3/4	69	7 1/8	181	9 5/8	244						48.8	22.1	57.2	25.9	60.6	27.5
70.2STEv							15 3/8	391	6 1/8	157		50.3	22.8	58.7	26.6	62.2	28.2
70.3STEh	2 3/4	69	7 1/8	181	9 5/8	244						52.1	23.6	60.5	27.4	63.9	29
70.3STEv							15 3/8	391	6 1/8	157		53.6	24.3	62	28.1	65.5	29.7
80.2STEh	3 3/16	81	8 11/16	221	10 11/16	272						70.6	32	87.2	39.5	99.9	45.3
80.2STEv							16 13/16	427	6 3/4	172		72.2	32.7	88.7	40.2	99.9	45.3
80.3STEh	3 3/16	81	8 11/16	221	10 11/16	272						74	33.5	90.5	41	102.7	46.6
80.3STEv							16 13/16	427	6 3/4	172		75.5	34.2	92.1	41.7	102.7	46.6

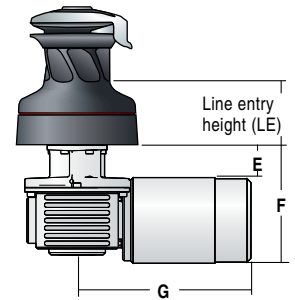

Hydraulic																
46.2STH							9 1/4	234	5 1/8	130	28	12.7	33.8	15.3	36.2	16.4
50.2STH							9 1/4	234	5 1/8	130	29.8	13.5	36.9	16.7	39.5	17.9
60.2STH							9 1/4	234	5 1/8	130	39.1	17.7	47.2	21.4	50.5	22.9
60.3STH							9 1/4	234	5 1/8	130	42.4	19.2	50.6	22.9	53.8	24.4
70.2STH							9 1/4	234	5 1/8	130	41.5	18.8	49.9	22.6	53.4	24.2
70.3STH							9 1/4	234	5 1/8	130	44.8	20.3	53.2	24.1	56.7	25.7
80.2STH							9 7/8	250	5 1/8	130	66.4	30.1	83	37.6	97.9	44.4
80.3STH							9 7/8	250	5 1/8	130	69.8	31.6	86.3	39.1	97.9	44.4

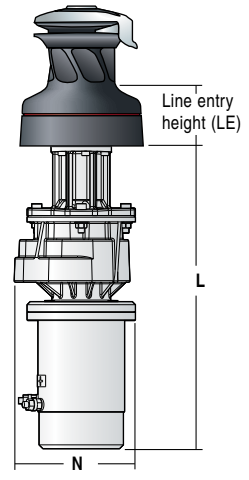

Winch size	Electric motor configuration		Nominal voltage			Power in watts		
	Horizontal(STEH)	Vertical(STEV)	12V	24V	48V	12V	24V	48V
35.2 - 40.2	•	—	•	•	•	700	900	2000
46.2	•	•	•	•	•	700	900	2000
50.2	•	•	•	•	•	1500	2000	2000
60.2 - 60.3	•	•	•	•	•	1500	2000	2000
70.2 - 70.3	•	•	•	•	•	1500	2000	2000
80.2 - 80.3	•	•	•	•	•	1500	2000	2000

Electric Wire Gauges

Winch size	Current voltage	Total distance between winch and battery							
		Under 16.4' AWG	Under 5 m mm ²	16.4 - 32.8' AWG	5 - 10 m mm ²	32.8 - 49.2' AWG	10 - 15 m mm ²	49.2 - 65.6' AWG	15 - 20 m mm ²
35.2 - 40.2	12V	2	32	0	50	00	70	000	95
35.2 - 40.2	24V	5	16	4	25	2	35	0	50
35.2 - 40.2	48V	8	10	6	16	6	16	4	25
46.2	12V	2	32	0	50	00	70	000	95
46.2	24V	5	16	4	25	2	35	0	50
46.2	48V	8	10	6	16	6	16	4	25
50.2	12V	2	32	0	50	00	70	000	95
50.2	24V	5	16	4	25	2	35	0	50
50.2	48V	8	10	6	16	6	16	4	25
60.2 - 60.3	12V	2	32	0	50	00	70	000	95
60.2 - 60.3	24V	5	16	4	25	2	35	0	50
60.2 - 60.3	48V	8	10	6	16	6	16	4	25
70.2 - 70.3	12V	2	32	0	50	00	70	000	95
70.2 - 70.3	24V	5	16	4	25	2	35	0	50
70.2 - 70.3	48V	8	10	6	16	6	16	4	25
80.2 - 80.3	12V	2	32	0	50	00	70	000	95
80.2 - 80.3	24V	5	16	4	25	2	35	0	50
80.2 - 80.3	48V	8	10	6	16	6	16	4	25

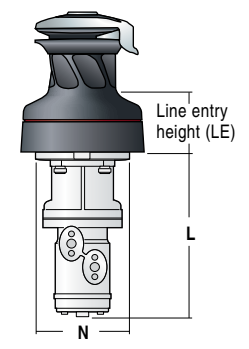

UniPower Winches

The UniPower is a single-speed winch that combines the advantages of a low-profile manual winch with the power of a 12-, 24-, or 48-volt, low-amp-draw motor. What makes it unique is that the motor is partially imbedded inside the drum, so that it extends only 105 mm (4 1/8") below the winch base—a critical feature for small boats where space under the cabintop is limited.

About Radial winches: see feature pages at beginning of this section.

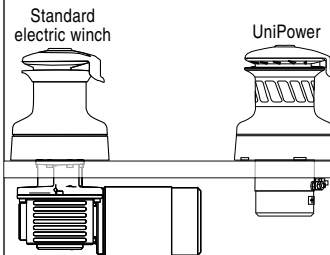

Low-profile electric motor saves headspace.



Eckernförde, Saare 38, 11.40 m, Karl-Johan Stråhlmann, Saare Yachts © Saare Yachts



500UPW



Works with handle if power is unavailable.

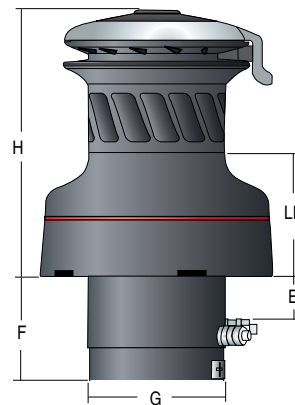

Dimensions

Part No.	Line entry height (LE)		E		F		G	
	in	mm	in	mm	in	mm	in	mm
500UPWA/C	3 1/4	83	1 7/8	48	3	76	3 5/16	85
900UPWA/C/CCC/BBB	3 15/16	100	1 3/8	35	4 1/8	105	5 1/2	140

Part No.	Ø		Base		Height (H)		Weight		Line Ø				Fastener circle		Fasteners (SH or HH)		Max pull	
	in	mm	in	mm	in	mm	lb	kg	Min	Max	in	mm	in	mm	in	mm	lb	kg
500UPWA	3 7/8	99	5 3/4	146	7 7/8	200	15	6.7	5/16	8	9/16	14	4 7/8	123	5 x 1/4	5 x M6	1102	500
500UPWC	3 7/8	99	5 3/4	146	7 7/8	200	18	8.3	5/16	8	9/16	14	4 7/8	123	5 x 1/4	5 x M6	1102	500
900UPWA	4 3/8	110	7 1/2	190	8 1/2	215	26.5	12	5/16	8	9/16	14	6 5/16	160	5 x 5/16	5 x M8	1984	900
900UPWC	4 3/8	110	7 1/2	190	8 1/2	215	32	14.5	5/16	8	9/16	14	6 5/16	160	5 x 5/16	5 x M8	1984	900
900UPWCCC	4 3/8	110	7 1/2	190	8 1/2	215	34.6	15.7	5/16	8	9/16	14	6 5/16	160	5 x 5/16	5 x M8	1984	900
900UPWBBB	4 3/8	110	7 1/2	190	8 1/2	215	34.6	15.7	5/16	8	9/16	14	6 5/16	160	5 x 5/16	5 x M8	1984	900

Specify voltage when ordering. Harken recommends the single function digital switch DSSBK4 and circuit breaker HCP1717. Sold separately.

Rewind Electric Winches

The Rewind Radial electric winch is the latest in Harken's "easy sailing" solutions for cruisers, and the first winch of its kind in the marine market. Activated remotely by twin in/out buttons, the Rewind safely eases and trims highly-loaded sails in both directions without ever taking the line out of the self-tailer.

Like all Harken electric winches, the Rewind operates like a normal 2-speed electric winch. A simple flip of the red knob on the winch base turns on the rewind feature. A spring-loaded arm of investment-cast stainless steel funnels and keeps line captive as it feeds in and out of the self-tailer as the sail is adjusted with fingertip control.

Available in 12-, 24-, and 48-volts.

About Radial winches: see feature pages at beginning of this section.



A Harken locking handle inserted into an unloaded winch automatically disconnects the motor gear for manual operation.



Activated remotely by twin in/out buttons, the Rewind winch safely eases and trims highly-loaded sails in both directions without ever taking the line out of the self-tailer.



A simple flip of the red knob on the winch base turns on the rewind feature.

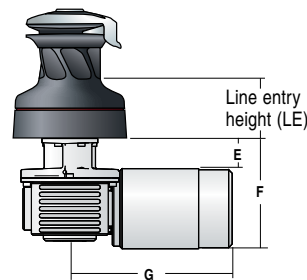

Part No.	Line entry height (LE)		E		F		G	
	in	mm	in	mm	in	mm	in	mm
40RWA/C/CCC/BBB	3 1/4	82	1 3/4	43	6 1/8	155	11	280
46RWA/C/CCC/BBB	3 9/16	90	1 3/4	43	6 1/8	155	11	280
60RWA/C/CCC/BBB	4 9/16	116	2 3/4	69	7 1/8	181	11	280

Part No.	Ø Drum		Ø Base		Height		Weight		Line Ø		Fastener circle		Fasteners (SH or HH)		Gear ratio		Power ratio			
	in	mm	in	mm	in	mm	lb	kg	in	mm	in	mm	in	mm	1	2	1	2		
40RWA	3 1/8	80	6 3/16	157	6 7/8	175	32.2	14.6	5/16	8	1/2	12	4 7/8	123	5 x 1/4	5 x 6	2.13	6.28	13.50	39.90
40RWC	3 1/8	80	6 3/16	157	6 7/8	175	35.7	16.2	5/16	8	1/2	12	4 7/8	123	5 x 1/4	5 x 6	2.13	6.28	13.50	39.90
40RWCCC/BBB	3 1/8	80	6 3/16	157	6 7/8	175	37.5	17	5/16	8	1/2	12	4 7/8	123	5 x 1/4	5 x 6	2.13	6.28	13.50	39.90
46RWA	3 7/8	100	7 1/4	184	8	203	35.3	16	3/8	10	9/16	14	5 7/8	150	5 x 5/16	5 x 8	2.30	9.17	11.70	46.50
46RWC	3 7/8	100	7 1/4	184	8	203	41	18.6	3/8	10	9/16	14	5 7/8	150	5 x 5/16	5 x 8	2.30	9.17	11.70	46.50
46RWCCC/BBB	3 7/8	100	7 1/4	184	8	203	43.4	19.7	3/8	10	9/16	14	5 7/8	150	5 x 5/16	5 x 8	2.30	9.17	11.70	46.50
60RWA	4 3/4	120	9 5/16	236	9 11/16	246	48.7	22.1	9/16	14	5/8	16	8	204	6 x 5/16	6 x 8	4.80	14.40	20.30	61.00
60RWC	4 3/4	120	9 5/16	236	9 11/16	246	56.9	25.8	9/16	14	5/8	16	8	204	6 x 5/16	6 x 8	4.80	14.40	20.30	61.00
60RWCCC/BBB	4 3/4	120	9 5/16	236	9 11/16	246	60.2	27.3	9/16	14	5/8	16	8	204	6 x 5/16	6 x 8	4.80	14.40	20.30	61.00



Catamaran Outremer 55' © Robin Christol

PERFORMA WINCHES

Harken Performa winches combine the high-efficiency of the Radial line with the sandblasted grip of Harken carbon-fiber racing winches for powerful hybrids. Optimized to handle the high-strength line used on sport-boats and performance cruisers, Performa winches are a great solution for crew who don't wish to invest in carbon winches or who need racing winches in smaller sizes. Winches come in self-tailing, plain-top, or Quattro styles; manual, electric (12- or 24-volt), or hydraulic drives. Available in sizes 20 to 80 to complement Harken's carbon line.



Maximum holding power for high-tech line

- Sandblasted drums and ribs optimized for halyard and sheeting applications using small-diameter, high-strength line.

Trim and ease sails quickly and easily

- Patented angle of ribs drives line wraps down when easing to keep them on area of drum that provides best control.
- Transfer high loads to the winch with fewer wraps.

High-strength, lightweight

- Lightweight aluminum drum features an integrated skirt.
- High-strength composite roller and ball thrust bearings reduce friction under load.
- Load-carrying gears and pins are 17-4 PH stainless steel for strength, corrosion resistance.

DO NOT use Harken equipment for human suspension unless product is specifically certified and labeled for such use.



Quattro model for boats requiring extremely fast winches

- Handles large asymmetrical spinnakers; power to trim genoa upwind.
- 2 speeds + 2 drum diameters = 4 line speeds.



Power-grip jaws shaped for easy line entry, optimum hold

- Narrow composite jaws ensure superior holding power on small-diameter, high-strength line.
- Lower jaw adjusts under line pressure; accepts a variety of line sizes.
- Teeth grip evenly with or without load.



Simple to install, easy maintenance

- Stud mounting bolts allow fast installation. Drum removes easily with a flathead screwdriver.
- Snap-fit design keeps bearings captive when drum is removed for maintenance.
- Easy to disassemble for service on deck; socket, washer, and screw-top snap-fit together for mistake-free reassembly.
- Composite roller bearings don't require lubrication.

Adjustable stripper arm integrated into winch top for safer operation

- Stripper arm completely covers rotating winch top, preventing fingers and clothing from catching in moving parts.
- Adjusts to multiple positions after the winch is mounted to optimize line exit.
- Shaped to smoothly feed line in and out of self-tailing jaws.



Powered Options

- Electric: vertical-mount motors; horizontal-mount motors offered with right- or left-mount option.
- Hydraulic: vertical-mount motor.

Easy upgrade from manual to power

- Manual winches easily convert to powered using patented conversion method.
- No adapter plate required; identical stud pattern to mount winches of the same size without drilling new holes in deck.

- A predrilled hole in deck by builder simplifies manual-to-electric conversion; removable gaskets offered to seal holes until upgrade is made.

Energy-efficient motors accomplish more work per unit of electricity consumed

- Motors attach to central drive shaft and drive through winch gears for two-speed mechanical advantage.
- Low-power first gear for fast trimming; higher-power second gear for fine-tuning loaded sheets.

- Efficient design allows smaller motor size.

Manual override in case of power loss

- Harken locking handle inserted into an unloaded winch automatically disconnects motor gear for manual operation.



Performa Winches

About Performa winches: see feature pages at beginning of this section.

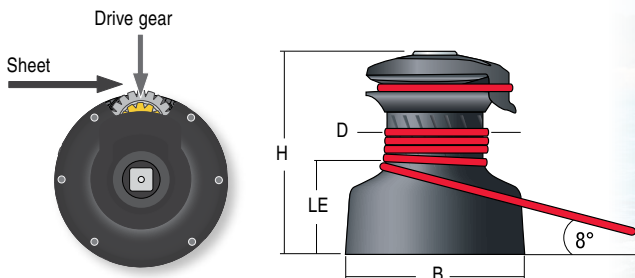

CLASSIC PLAIN-TOP



PLAIN-TOP

Use plain-top winches on sportboats where sails require frequent trimming. Plain-top winches are best handled by two crew—one to trim and one to tail the line.



SELF-TAILING

Self-tailing winches have narrow composite jaws to ensure superior holding power on small-diameter line. The self-tailing mechanism on the winch means that one crew member can quickly and easily trim or raise sails.



QUATTRO

Use Quattro models for boats requiring extremely fast winches. Quattros handle large asymmetrical spinnakers and provide power to trim genoa upwind. 2 speeds + 2 drum diameters = 4 line speeds.



Part No.	Drum (D)		Base (B)		Height (H)		Weight		Line entry height (LE)		Line Ø		Fastener circle		Fasteners (SH or HH)		Gear ratio			Power ratio			
	in	mm	in	mm	in	mm	lb	kg	in	mm	Min	Max	in	mm	in	mm	1	2	3	1	2	3	
Classic Plain-Top																							
B6A	2 3/8	60	3 9/16	90	3 1/4	82	1.5	0.7	1 5/16	33			2 9/16	65	6 x 1/4 FH	6 x 6 FH	1					8.4	
B8A	2 11/16	68	4 1/2	115	3 9/16	90	2.4	1.1	1 1/2	38			3 9/16	90	4 x 5/16 FH	4 x 8 FH	1					7.5	
Plain-Top																							
20.2PTP	2 7/8	73	5 3/8	137	5 1/16	128	4.4	2	2 3/8	61			4 3/8	110	5 x 1/4*	5 x M6	1	2.76		6.95	19.2		
35.2PTP	3 1/8	80	5 7/8	149	5 13/16	148	6.8	3.1	3 1/8	79			4 7/8	123	5 x 1/4*	5 x M6	2.13	5.65		13.50	35.90		
40.2PTP	3 1/8	80	6 3/16	157	6	153	7.7	3.5	3 1/4	82			4 7/8	123	5 x 1/4*	5 x M6	2.13	6.28		13.50	39.90		
46.2PTP	3 15/16	100	7 1/4	184	7 1/16	179	11.3	5.1	3 9/16	90			5 7/8	150	5 x 5/16	5 x M8	2.30	9.17		11.70	46.50		
50.2PTP	4 5/16	110	7 11/16	195	7 1/2	190	13	5.9	3 13/16	97			5 7/8	150	5 x 5/16	5 x M8	2.40	10.90		11.10	50.40		
Self-Tailing																							
20STP	2 7/8	73	5 3/8	137	5 13/16	148	5.3	2.4	2 3/8	61	1/4	6 1/2	12	4 3/8	110	5 x 1/4*	5 x M6	2.76			19.20		
30.2STP	2 7/8	73	4 3/4	120	6	152.4	6	2.7	2 3/10	59	1/4	6 1/2	12	4	100	5 x 1/4*	5 x M6	4.25	2.55		29.6	17.8	
35.2STP	3 1/8	80	5 7/8	149	6 11/16	170	7.9	3.6	3 1/8	79	5/16	8 1/2	12	4 7/8	123	5 x 1/4*	5 x M6	2.13	5.65		13.50	35.90	
40.2STP	3 1/8	80	6 3/16	157	6 7/8	175	8.4	3.8	3 1/4	82	5/16	8 1/2	12	4 7/8	123	5 x 1/4*	5 x M6	2.13	6.28		13.50	39.90	
46.2STP	3 15/16	100	7 1/4	184	7 15/16	202	11.5	5.2	3 9/16	90	5/16	8 9/16	14	5 7/8	150	5 x 5/16	5 x M8	2.30	9.17		11.70	46.50	
50.2STP	4 5/16	110	7 11/16	195	8 5/16	212	13.2	6	3 13/16	97	5/16	8 9/16	14	5 7/8	150	5 x 5/16	5 x M8	2.40	10.90		11.10	50.40	
50.3STP	4 5/16	110	7 11/16	195	8 5/16	212	15.0	6.8	3 13/16	97	5/16	8 9/16	14	5 7/8	150	5 x 5/16	5 x M8	1	2.40	10.90	4.62	11.10	50.40
55.3STP	4 5/16	110	7 11/16	195	8 5/16	212	15.0	6.8	3 3/16	97	5/16	8 9/16	14	5 7/8	150	5 x 5/16	5 x M8	1	2.40	11.85	4.3	11.10	55.20
60.2STP	4 3/4	120	9 5/16	236	9 11/16	246	22.5	10.2	4 9/16	116	5/16	8 5/8	16	8	204	6 x 5/16	6 x M8	4.80	14.4		20.30	61.00	
60.3STP	4 3/4	120	9 5/16	236	10 1/16	253	25.8	11.7	4 9/16	116	5/16	8 5/8	16	8	204	6 x 5/16	6 x M8	2.20	4.80	14.40	9.20	20.30	61.00
70.2STP	5 1/8	130	9 7/16	240	10 1/16	256	24.9	11.3	4 1/2	115	3/8	10 5/8	16	8 1/8	205	6 x 5/16	6 x M8	5.70	18.50		22.20	72.00	
70.3STP	5 1/8	130	9 7/16	240	10 3/8	264	28.3	12.8	4 1/2	115	3/8	10 5/8	16	8 1/8	205	6 x 5/16	6 x M8	2.30	5.70	18.50	9.00	22.20	72.00
80.2STP	6 7/8	175	11 5/16	287	12 9/16	320	46.8	21.2	6 7/16	164	3/8	10 11/16	18	9 3/16	233	8 x 3/8	8 x M10	9.94	32.12		28.85	93.24	
80.3STP	6 7/8	175	11 5/16	287	12 7/8	327	50.1	22.7	6 7/16	164	3/8	10 11/16	18	9 3/16	233	8 x 3/8	8 x M10	2.76	9.94	32.12	8.01	28.85	93.24
Quattro																							
40STQP	3 1/8**	80**	7 1/8	180	6 7/8	175	10.2	4.6	3 1/4**	82**	5/16	8 1/2	12	4 7/8	123	5 x 1/4*	5 x M6	2.13	6.28		13.50	39.90	
46STQP	3 15/16‡	100‡	8 1/2	218	7 15/16	202	13.7	6.2	3 9/16‡	90‡	5/16	8 9/16	14	5 7/8	150	5 x 5/16	5 x M8	2.30	9.17		11.70	46.50	

*SH only. **Refers to upper drum. Lower drum Ø = 154 mm (6 1/16"); line entry height = 24 mm (15/16").

‡Refers to upper drum. Lower drum Ø = 188 mm (7 13/32"); line entry height = 24 mm (15/16").

Electric and Hydraulic Performa Winches

Electric and hydraulic Performa winches let you trim any size sail with the push of a button.

Specify power type, voltage, and motor configuration when ordering. See part number explanation.

About Performa winches: see feature pages at beginning of this section.

Part Numbers

Specify power type, voltage, and motor configuration when ordering

46.2STEP12HLM

- Winch size** —————
- Number of speeds** ———
- Self-tailing** —————
- Power type** —————
- E = Electric H = Hydraulic
- Performa** —————
- P = Performa winch line
- Voltage** —————
- 12 = 12V 24 = 24V 48 = 48V
- Motor configuration** ———
- Specify for electric; hydraulic available in vertical only.
- H = Horizontal V = Vertical
- Left-mount option** ———
- Available in electric only. Additional letter code for left-mount option only; standard mounting part number ends with motor configuration.
- LM = Left-mount

Dimensions

Part No.	Racing disconnect rod*	E		F		G		L		N		Weight with motor	
		in	mm	in	mm	in	mm	in	mm	in	mm	lb	kg
Electric													
35.2STEPH	B35PDR	1 3/4	43	6 1/8	155	8 7/8	227					29.5	13.4
40.2STEPH	B40PDR	1 3/4	43	6 1/8	155	8 7/8	227					29.7	13.5
46.2STEPH	B46PDR	1 3/4	43	6 1/8	155	8 7/8	227					32.8	14.9
46.2STEPV	B46PDR							15 3/8	391	6 1/8	157	36.9	16.7
50.2STEPH	B50PDR	2 3/4	69	7 1/8	181	9 5/8	244					37.1	16.8
50.2STEPV	B50PDR							15 3/8	391	6 1/8	157	38.6	17.5
60.2STEPH	B60PDR	2 3/4	69	7 1/8	181	9 5/8	244					46.4	21
60.2STEPV	B60PDR							15 3/8	391	6 1/8	157	47.9	21.7
60.3STEPH	B60.3PDR	2 3/4	69	7 1/8	181	9 5/8	244					49.7	22.5
60.3STEPV	B60.3PDR							15 3/8	391	6 1/8	157	51.2	23.2
70.2STEPH	B70PDR	2 3/4	69	7 1/8	181	9 5/8	244					48.8	22.1
70.2STEPV	B70PDR							15 3/8	391	6 1/8	157	50.3	22.8
70.3STEPH	B70.3PDR	2 3/4	69	7 1/8	181	9 5/8	244					52.1	23.6
70.3STEPV	B70.3PDR							15 3/8	391	6 1/8	157	53.6	24.3
80.2STEPH	B80PDR	3 3/16	81	8 11/16	221	10 11/16	272					70.6	32
80.2STEPV	B80PDR							16 13/16	427	6 3/4	172	72.2	32.7
80.3STEPH	B80.3PDR	3 3/16	81	8 11/16	221	10 11/16	272					74	33.5
80.3STEPV	B80.3PDR							16 13/16	427	6 3/4	172	75.5	34.2
Hydraulic													
46.2STHP	B46PDR							9 1/4	234	5 1/8	130	28	12.7
50.2STHP	B50PDR							9 1/4	234	5 1/8	130	29.8	13.5
60.2STHP	B60PDR							9 1/4	234	5 1/8	130	39.1	17.7
60.3STHP	B60.3PDR							9 1/4	234	5 1/8	130	42.4	19.2
70.2STHP	B70PDR							9 1/4	234	5 1/8	130	41.5	18.8
70.3STHP	B70.3PDR							9 1/4	234	5 1/8	130	44.8	20.3
80.2STHP	B80PDR							9 7/8	250	5 1/8	130	80.9	36.7
80.3STHP	B80.3PDR							9 7/8	250	5 1/8	130	84.2	38.2

*When racing, insert a racing disconnect rod to operate the winch manually. Performa disconnect rods are also available for Radial winches.

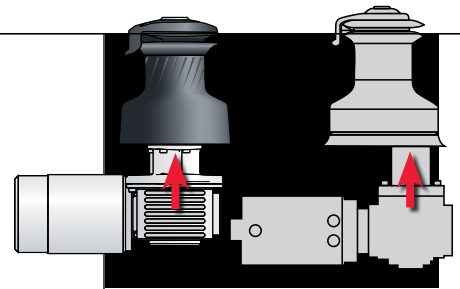

Harken electric and hydraulic motors attach to the central drive shaft and drive through the winch gears for a 2-speed mechanical advantage—the low-power first gear for fast trimming, the higher-power second gear for fine-tuning loaded sheets. This results in reduced battery drain and a more efficient motor on the electric version. The energy-efficient hydraulic version is also smaller, reducing weight and cost.

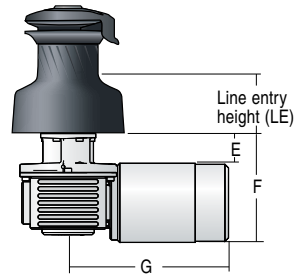

ELECTRIC HORIZONTAL

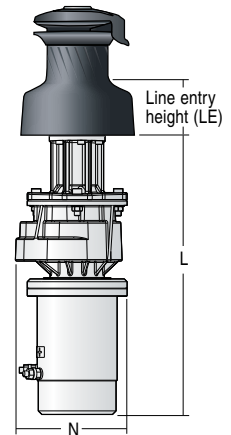

ELECTRIC VERTICAL

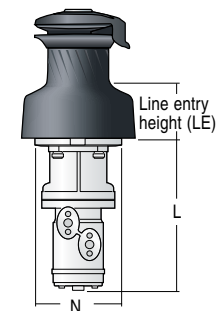

HYDRAULIC



Electric Components

Battery voltage and winch size determine which components you should use. For winches size B980 and above, contact Harken for appropriate components. All components sold separately.

Each electric winch requires one control box, one circuit breaker, and two analog switches or one Digital System Switch. All new electric Radial, Performa, and captive winches are supplied with the appropriate dual-function control box. For replacement or retrofit control boxes, contact Harken.

Hydraulic winches require two analog switches or one Digital System Switch.

Analog Switches

Harken offers simple, waterproof switches for electric and hydraulic winches. Order two switches for each winch.

High-Amperage Circuit Breakers

Harken offers four panel-mount, high-amperage circuit breakers. They are compact, waterproof, weather-resistant, and ignition-protected. Circuit breakers are available for 12-, 24-, or 48-volt DC systems.

Dual-Function Control Boxes

This labor-saving control box with built-in load controller combines two products into one, reducing wiring and connection points by almost half, greatly simplifying installation of Harken electric winches. Supports Digital System Switch or analog switches. A mix of switches is not supported.

System wiring may be different depending on winch size and installation. Please refer to the user manual for additional connection information.

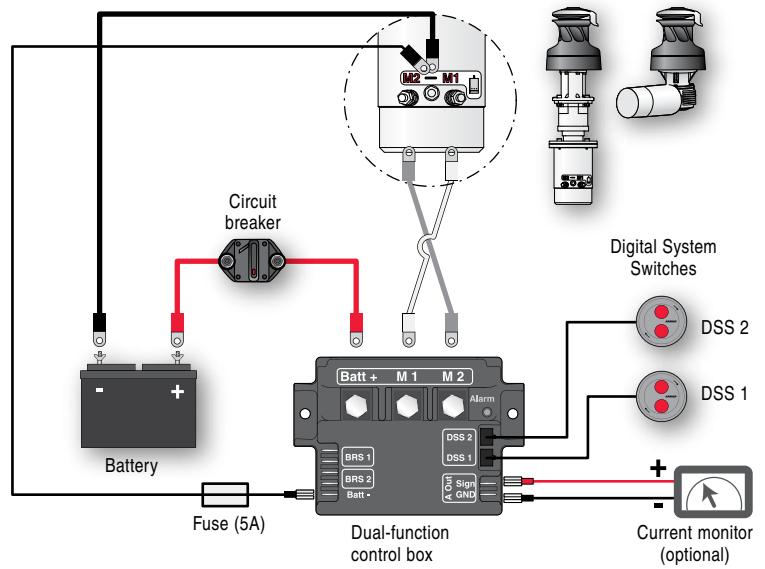

CIRCUIT BREAKERS

DUAL-FUNCTION CONTROL BOXES



BRS102/P

BRS102/S

BRS104/P

ANALOG SWITCHES

Analog Switches

Part No.	Description	Length		Width		Height		Weight	
		in	mm	in	mm	in	mm	oz	g
BRS102/S	Remote switch w/guard	2 11/16	68	2 11/16	68	13/16	21	10.4	295
BRS102/P	Remote switch w/guard	2 11/16	68	2 11/16	68	13/16	21	4.8	135
BRS104/P	Remote switch w/guard	3 3/8	85	3	76	3/4	19	3.4	95

	HCP1717 80 Amps			HCP1718 100 Amps	HCP1719 150 Amps	HCP1720 135 Amps	
Winch size	12	24	48	12	12	12	24
35.2	.	.	.				
40.2	.	.	.				
46.2	.	.	.				**
50.2
60.2
60.3
70.2
70.3
80.2
80.3
500UPW		.	.		.		
900UPW		.	.	.			
FW250	.	.	.				
FW500		
40REW	.	.	.				
46REW	.	.	.				
60REW
CLR600
CLR1200
CLR2500

** Vertical motorization

Digital System Switches

Harken Digital System Switches in dual and single-function models set the standard for the reliable operation of electrically-powered yacht systems.

To accomplish this, safeguards have been built into the systems.

- The waterproof control button translates electrical information into a binary code that won't allow the system to start without the signals being verified by the decoder. An analog system sends continuous electrical information directly to the powered device which means damage to the wiring or water ingress could result in unsafe activation.
- Watertight seals are never exposed, eliminating potential damage from sun and prolonged use.
- Underneath each control button, two command switches must work in unison before a signal is sent.

Harken Digital System Switches resist impact, wear, and abrasion. A unique adhesive mounting system is available where drilling is undesirable. The product is offered in black polyamide resin or stainless steel.

Dual-function







Two-function control buttons housed in a single space-saving system—1st/2nd gear for winches, up/down for anchors, in/out for furling.

Single-function

Single control button—Pairs with the Harken UniPower single-speed winch used by cruisers.



Active buttons:
1st/2nd gear for winches, up/down for anchors, in/out for furling.

Button symbol	Part No. Ending
 	1 = 1/2
 	2 = Left/right or In/out
 	3 = Up/down
	4 = Start

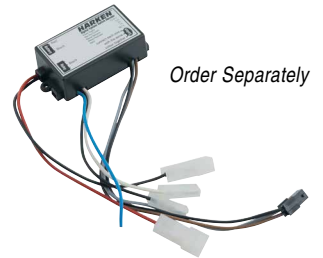

Order Separately



DUAL-FUNCTION



SINGLE-FUNCTION

First 44 Performance © Julien Gazeau / BENETEAU



Part No.	Description	Ø		Height		Weight	
		in	mm	in	mm	oz	g
Dual-function							
DSDBK1-ND	Dual function digital switch/1-2	3 1/8	79.6	1	25.5	4.23	120
DSDSS1-ND	Dual function digital switch/1-2	3 3/16	80.5	1 1/32	26	4.59	130
DSDBK2-ND	Dual function digital switch/left-right or in-out	3 1/8	79.6	1	25.5	4.23	120
DSDSS2-ND	Dual function digital switch/left-right or in-out	3 3/16	80.5	1 1/32	26	4.59	130
DSDBK3-ND	Dual function digital switch/up-down	3 1/8	79.6	1	25.5	4.23	120
DSDSS3-ND	Dual function digital switch/up-down	3 3/16	80.5	1 1/32	26	4.59	130
Single-function							
DSSBK4-ND	Single function digital switch/black	3 1/8	79.6	1	25.5	4.23	120
DSSSS4-ND	Single function digital switch/stainless steel	3 3/16	80.5	1 1/32	26	4.59	130

CLR Mooring Winch

DAME
CATEGORY WINNER
2018

The Harken CLR mooring winch is a flush-stowing, deck-mounted powered winch for both sail and power yachts featuring geometry and mechanical characteristics never before seen.

No other retracting, flush-mounted winch has offered the power-for-size ratio offered by the CLR. It stows completely belowdeck and occupies less horizontal and vertical space than required by the competition. The CLR is also lighter than the competition while delivering comparable mechanical advantage.

This compact form makes it possible for yachts to mount two CLR winches at the stern quarters and one in the bow. Together, three CLR's can reduce the need for engine and thruster power while helping crews moor stern-to-dock.

The CLR employs unprecedented winch drum geometry. Five aluminum columns rotate together around a center axis. Working together, they create a very light drum that provides substantially more line-holding power and low-speed torque than would be available using a traditional drum.

The CLR offers internal LED lights at the bottom of each column for use in low-light mooring situations. Deck plates are available in aluminum, stainless steel, or customizable. Columns come in black aluminum or stainless steel finishing.

Harken produces six sizes of the CLR available in 12, 24 V, 48 V, or 400 VAC electric or hydraulic power. With maximum holding load ranges from 600 to 12000 kg, CLR mooring winches can be used on boats from 13.7 to 91.4 m (45' - 300').



LED lights are integrated at the bottom of each column for low-light mooring situations.

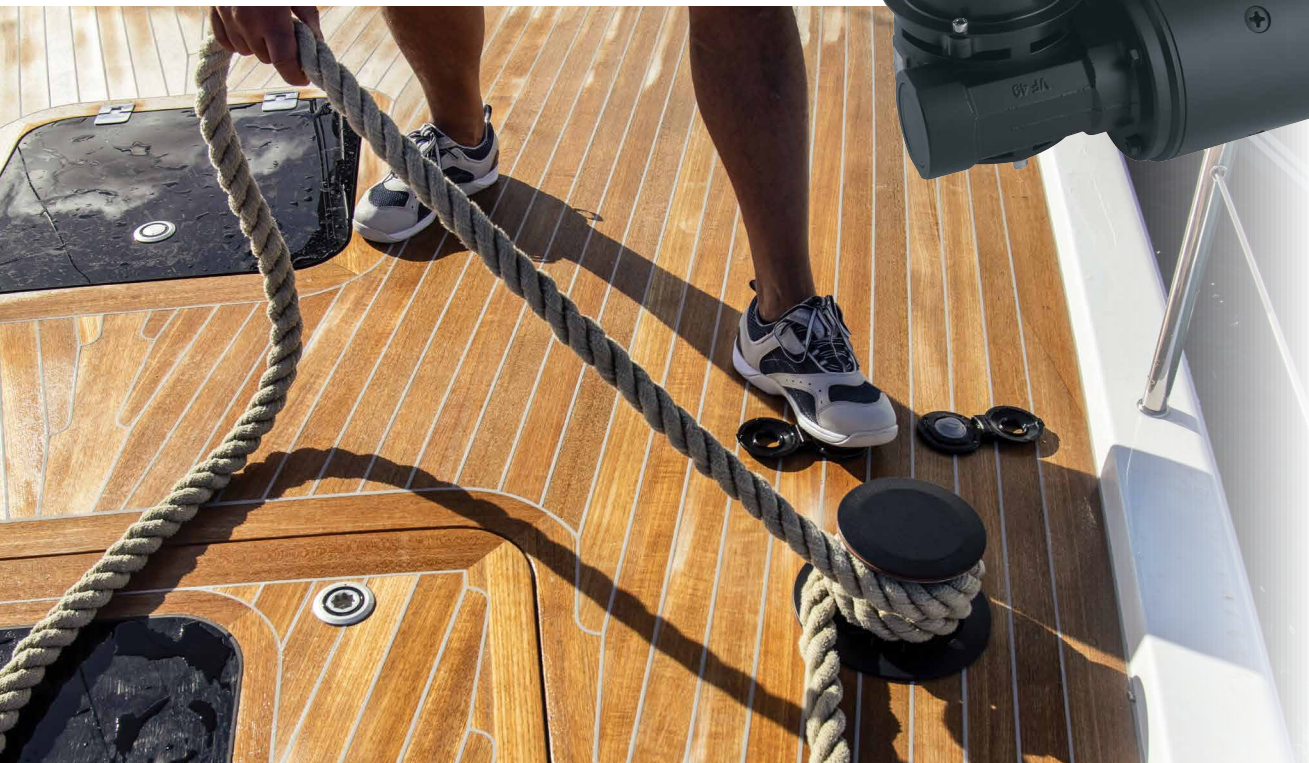

CLR Mooring Winch

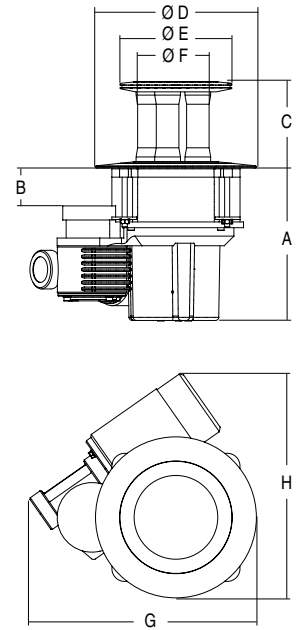

Winch size	Line Ø		Max line speed*		Maximum holding load		Maximum pulling load		Boat length**	Deck plate material					
	in	mm	ft/min	m/min	lb	kg	lb	kg		ft	Aluminum (A)	Stainless steel (SS)	Custom (TC)		
Electric															
CLR600E	1/2	12	11/16	18	59	18	1320	600	660	300	45 - 60	13.7 - 18.3	•	•	•
CLR1200E	1/2	12	11/16	18	49.2	15	2640	1200	1320	600	60 - 90	18.3 - 27.4	•	•	•
CLR2500E24V	1/2	12	15/16	24	55.8	17	5500	2500	2750	1250	90 - 120	27.4 - 36.6	•	•	•
CLR2500E400V	1/2	12	15/16	24	65.6	20	5500	2500	2750	1250	90 - 120	27.4 - 36.6	•	•	•
CLR4000E24V	5/8	16	1 3/16	30	75.5	23	8800	4000	4400	2000	120 - 190	36.6 - 57.9	•	•	•
CLR4000E400V	5/8	16	1 3/16	30	59	18	8800	4000	4400	2000	120 - 190	36.6 - 57.9	•	•	•
CLR8000E	7/8	22	1 3/8	35	72.2	22	17600	8000	8800	4000	190 - 250	57.9 - 76.2	•	•	•
CLR12000E	7/8	22	1 9/16	40	7.2	22	26400	12000	13200	6000	250 - 300	76.2 - 91.4	•	•	•
Hydraulic															
CLR600H	1/2	12	11/16	18	59	18	1320	600	660	300	45 - 60	13.7 - 18.3	•	•	•
CLR1200H	1/2	12	11/16	18	49.2	15	2640	1200	1320	600	60 - 90	18.3 - 27.4	•	•	•
CLR2500H	1/2	12	15/16	24	55.8	17	5500	2500	2750	1250	90 - 120	27.4 - 36.6	•	•	•
CLR4000H	5/8	16	1 3/16	30	72.2	22	8800	4000	4400	2000	120 - 190	36.6 - 57.9	•	•	•
CLR8000H	7/8	22	1 3/8	35	72.2	22	17600	8000	8800	4000	190 - 250	57.9 - 76.2	•	•	•
CLR12000H	7/8	22	1 9/16	40	7.2	22	26400	12000	13200	6000	250 - 300	76.2 - 91.4	•	•	•

*Line speed is measured with no load. **Approximate data.

Dimensions

Winch size	B																	
	A		Min		Max		C		D		E		F		G		H	
in	mm	in	mm	in	mm	in	mm	in	mm	in	mm	in	mm	in	mm	in	mm	
Electric																		
CLR600E	9 13/16	250	5/8	15	2 15/16	75	4 5/16	110	7 7/8	200	5 11/16	144	3 11/16	94	12 17/32	318	14	355
CLR1200E	9 5/16	237	5/8	15	2 5/32	55	5 5/16	135	9 27/32	250	6 27/32	174	4 11/16	119	13 5/8	346	13 25/32	350
CLR2500E24V	9 13/16	250	5/8	15	2 5/32	55	5 1/8	130	12 3/16	310	8 7/32	209	5 1/2	140	15 15/16	405	16 9/16	420
CLR2500E400V	12 1/16	307	5/8	15	2 5/32	55	5 1/8	130	12 3/16	310	8 7/32	209	5 1/2	140	22 19/32	574	20 9/32	515
CLR4000E24V	19 3/8	492	25/32	20	4 23/32	120	9 5/8	244	14 3/8	365	9 5/8	244	7 9/32	185	22 1/16	560	23 13/16	605
CLR4000E400V	25 1/32	636	25/32	20	4 23/32	120	9 5/8	244	14 3/8	365	9 5/8	244	7 9/32	185	19 1/32	483	30 3/8	771
CLR8000E	26 1/2	673	31/32	25	4 3/16	106	9 3/4	247	16 3/4	425	12 3/16	309	9 27/32	250	24 13/32	620	43 13/16	1113
CLR12000E	29	736	31/32	25	4 3/16	106	12 3/16	310	16 3/4	425	12 3/16	309	9 27/32	250	24 13/32	620	43 13/16	1113
Hydraulic																		
CLR600H	9 13/16	250	5/8	15	2 15/16	75	4 5/16	110	7 7/8	200	5 11/16	144	3 11/16	94	12 17/32	318	14	355
CLR1200H	9 5/16	237	5/8	15	2 5/32	55	5 5/16	135	9 27/32	250	6 27/32	174	4 11/16	119	13 5/8	346	13 25/32	350
CLR2500H	9 13/16	250	5/8	15	2 5/32	55	5 1/8	130	12 3/16	310	8 7/32	209	5 1/2	140	15 15/16	405	16 9/16	420
CLR4000H	19 3/8	492	25/32	20	4 23/32	120	9 5/8	244	14 3/8	365	9 5/8	244	7 9/32	185	22 1/16	560	19	482
CLR8000H	26 1/2	673	31/32	25	4 3/16	106	9 3/4	247	16 3/4	425	12 3/16	309	9 27/32	250	24 13/32	620	30 7/16	773
CLR12000H	26 1/2	673	31/32	25	4 3/16	106	12 3/16	310	16 3/4	425	12 3/16	309	9 27/32	250	24 13/32	620	30 7/16	773

Aluminum Powered Winches

Harken aluminum winches are hardcoat-anodized to resist corrosion. Anodization colors can be customized to match your yacht's aesthetics. Winches are also available with carbon fiber tops and skirts.

Harken megayacht winches are kings of power and speed that will set you on the path to fast, efficient sail handling. Contact a Harken project manager to configure optimal gear ratios, electric or hydraulic motor selection, and power settings for your application, ensuring your winches perform at full potential—from superfast line speeds needed for jibes, to hoisting a wet headsail to the top of the mast in fast gear.

B990.2STAAA
B990.3STAAA



B1000STAAA



B1145STAAA



B1145STGGG



Product not stocked. Contact Harken to request quote and lead time.

Stainless Steel Powered Winches

Harken stainless steel winches come standard with durable, lustrous classic stainless finish. For an even more stunning look, they can be polished to a mirror-finish.

As is true with all of the largest Harken winches, our stainless winches provide both power, speed and energy efficiency required for fast, reliable sail handling. Harken project managers are available to help configure optimal gear ratios, motor selection, and power settings, for any application.



B1120HL-ST



B1130ST
B1235ST
B1335ST

Product not stocked. Contact Harken to request quote and lead time.



Bronze Powered Winches

Bronze finish winches enhance your yacht's classic look, while providing the low-friction pulling power available from Harken's gearing systems. Marine-grade, polished-bronze maximizes durability and corrosion resistance.

All Harken megayacht winches offer a comprehensive range of power and speed that will set you up for fast, efficient sail handling. Your Harken project manager is available to work with you on gear ratios, motor selection, and power settings, ensuring your winches perform at full potential—from superfast line speeds when jibing, to the power to finish a tack in the biggest breeze.



Winch tops can be engraved with your yacht's name.

B1111.3PTBBB



B1150.3STBBB



S/Y Doña Francisca, Designer: Javier Soto Acebal, Builder: Astillero Buquebus

Product not stocked. Contact Harken to request quote and lead time.



Carbon Fiber Winches

Carbon winches are standard in many racing classes and are the choice of performance-oriented fast cruisers.

Winches feature carbon skirts and tops, aluminum drums, and strong composite jaws with one-piece sculpted line guide and peeler. PEEK roller bearings are low-maintenance, reliable, and efficient. They ride in large-diameter cages, allowing more bearings to carry the load. Stainless steel drive gears are strong and durable. The AC versions of the 65.3ST and 65.2ST winches feature titanium gears for extremely high strength-to-weight ratios and exceptional resistance to corrosion.

Carbon winches come with up to three speeds and can be driven by handle, pedestal, or by electric or hydraulic motors. Harken's 50.3STR is the smallest three-speed direct drive self-tailing winch in the industry.

Harken designed the 600.3STR wide-body, self-tailing winch for use on Fast 40+ class boats for use as primary and mainsheet winches. The 600.3STR, which is made from aluminum, is a direct drive three-speed winch that can be driven by handle or pedestal.

Options include self-tailing arms, top cleats, free-spinning or ratcheting base sheave additions, and left-handed rotation.

If class rules dictate, winches are also available in all-aluminum with stainless steel gears.



B50.3STR



B50.2STR



B500.3TCR



B500.2STR



B600.3STR



B65.3TCR



B65.2STR



B65.3STAC



B65.2STAC



© Banque Populaire

Product not stocked. Contact Harken to request quote and lead time.

Carbon Fiber Winches

These powerful carbon winches are aboard large megayachts, performance cruisers, and racing monohulls and multihulls over 18 m (60').

Winches feature carbon skirts and tops, aluminum drums, and strong composite jaws with one-piece sculpted line guide and peeler. PEEK roller bearings are low-maintenance, reliable, and efficient. They ride in large-diameter cages, allowing more bearings to carry the load. Stainless steel drive gears are strong and durable. The AC versions of the 1111PT and 990.3ST winches feature titanium gears for extremely high strength-to-weight ratios and exceptional resistance to corrosion.

Drives are pedestal, electric, or hydraulic. Wide-diameter drums provide extra surface area to hold line securely under high loads. Fewer wraps speed line retrieval when sheeting.

Other options include self-tailing, top cleats, four speeds, free-spinning or ratcheting base sheave additions, and left-handed rotation.

If class rules dictate, winches are also available in all-aluminum with stainless steel gears.



B990.3TCR



B990.3STAC

5T



B1111.3PTAC

5.5T



B1111.3STR



B1125.3STR

7T



B1130.3TCR

9T



B1130.3STR



B1135/B1235.3STR

11T



B1145.3TCR

13T



B1145.3STR

Product not stocked. Contact Harken to request quote and lead time.

Carbon Fiber Winches

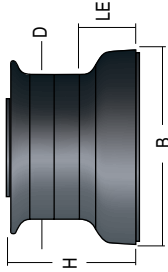
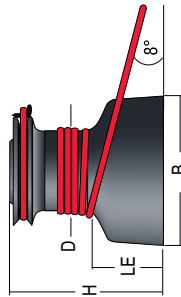
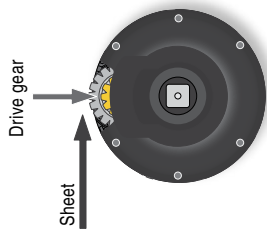

Base riser required to mount B50, B55, and B65 winches above deck. Specify above deck or flush deck version when ordering.



Use base sheaves for cross-sheaving and lazy sheets. Availability varies by winch size.

Part No.	Drum (D)		Base (B)	Height (H)		Weight	Line Ø		Line entry height (LE)	Fastener circle		Fasteners				Gear ratio				Power ratio						
	in	mm		in	mm		lb	kg		Min	Max	in	mm	in	mm	in	mm	in	mm	1	2	3	4	1	2	3
B50.2STR†	4.9/16	116	7 1/4	184	6.5/8	188	11.7	5.3	3/16	5	3/8	10	2.9/16	65	6.15/32	164	6 x 5/16 FH	6 x 8 FH	2.7:1	11.4:1	11.7:1	50.7:1	4.4:1	11.7:1	49.8:1	
B50.3STR	4.9/16	116	7 1/4	184	6.7/8	175	13.7	6.2	3/16	5	3/8	10	2.9/16	65	6.15/32	164	6 x 5/16 FH	6 x 8 FH	1:1	2.7:1	11.4:1		4.4:1	11.7:1	49.8:1	
B500.2STR	4.9/16	116	7 1/4	184	6.5/8	188	11	5	3/16	5	3/8	10	2.9/16	65	6.15/32	164	6 x 5/16 FH	6 x 8 FH	2.7:1	11.4:1		11.7:1	50.7:1			
B500.3TR	5/8	130	7 1/4	184	6.7/8	175	13.7	6.2					2.5/32	55	6.15/32	164	6 x 5/16 FH	6 x 8 FH	1:1	2.7:1	11.4:1		3.9:1	10.4:1	44.5:1	
B65.2STR**	5/8	149	10	255	7.13/16	199	20.9	9.5	5/16	8	5/8	16	3.1/4	83	8.29/32	226	6 x 5/16 FH	6 x 8 FH	4.6:1	19.2:1		15.7:1	65.5:1			
B65.2STAC	5/8	149	10	255	7.13/16	199			5/16	8	5/8	16	3.11/32	85	8.29/32	226	6 x 5/16 FH	6 x 8 FH	4.6:1	19.2:1		15.7:1	65.5:1			
B65.3STR**	5/8	149	10	255	8.29/32	226	26	11.8	5/16	8	5/8	16	3.1/4	83	8.29/32	226	6 x 5/16 FH	6 x 8 FH	1:1	4.6:1	19.2:1		3.4:1	15.7:1	65.5:1	
B65.3TR	5/8	149	10	255	8.29/32	226	25.4	11.5					3.1/4	83	8.29/32	226	6 x 5/16 FH	6 x 8 FH	1:1	4.6:1	19.2:1		3.4:1	15.7:1	65.5:1	
600.3STR	5/8	130	7 1/4	184	6.7/8	175	15.0	6.8	3/16	5	3/8	10	2.9/16	65	6.15/32	164	6 x 5/16 FH	6 x 8 FH	1:1	2.66:1	14.60:1		3.9:1	10.42:1	57.05:1	
B650.3STR	5/8	149	9	228	7.7/32	183	21.1	9.6	5/16	8	5/8	16	3.1/4	83	9.27/32	250	5 x 5/16 FH	5 x 8 FH	1:1	4.6:1	19.2:1		3.4:1	15.7:1	65.5:1	
B650.3TR	5/8	149	9	228	7.7/32	183	20	9.1					3.1/4	83	9.27/32	250	5 x 5/16 FH	5 x 8 FH	1:1	4.6:1	19.2:1		3.4:1	15.7:1	65.5:1	
B990.3STR	8	203	11	280	9.1/2	241	44.8	20.3	7/16	11	3/4	19	3.27/32	98	9.3/16	233	8 x 5/16 FH	8 x 8 FH	1:1	9.9:1	40:1		2.5:1	24.8:1	100:1	
B990.3STAC	8	203	13.1/16	332	9.7/16	240			7/16	11	3/4	19	3.27/32	98	12	305	8 x 5/16 FH	8 x 8 FH	1:1	9.9:1	40:1		2.5:1	24.8:1	100:1	
B990.3TR	8	203	11	280	9.7/16	240	41.5	18.8					3.27/32	98	9.3/16	233	8 x 5/16 FH	8 x 8 FH	1:1	9.9:1	40:1		2.5:1	24.8:1	100:1	
B1111.3STR*	11.1/32	280	14.3/16	360	9.5/16	236	54	24.5	7/16	11	3/4	19	3.11/16	94	10.21/32	271	8 x 3/8 SH	8 x 10 SH	1:1	9.7:1	44.7:1		1.8:1	17.6:1	81:1	
B1111.3TR	11.1/32	280	14.3/16	360	8.5/32	207	41	18.6					3.11/16	94	10.11/16	271	8 x 3/8 SH	8 x 10 SH	1:1	9.7:1	44.7:1		1.8:1	17.6:1	81:1	
B1111.3PTAC*	11.1/32	280	14.3/16	360	8.19/32	218							3.11/16	94	10.21/32	271	8 x 3/8 SH	8 x 10 SH	1:1	3:1	9.7:1	44.7:1	1.8:1	5.4:1	17.6:1	81:1
B1111.3STAC	11.1/32	280	14.3/16	360	9.9/32	236			7/16	11	3/4	19	3.11/16	94	10.21/32	271	8 x 3/8 SH	8 x 10 SH	1:1	3:1	9.7:1	44.7:1	1.8:1	5.4:1	17.6:1	81:1
B1130.3STR	12.3/4	324	16.3/32	409	12.1/8	308	86	39	5/8	16	1	25	4.17/32	115	12.3/4	324	9 x 1/2 SH	9 x 12 SH	1:1	10.8:1	55.2:1		1.6:1	16.9:1	86.6:1	
B1130.3TR	12.3/4	324	16.3/32	409	11.17/32	293	86	39					4.17/32	115	12.3/4	324	9 x 1/2 SH	9 x 12 SH	1:1	10.8:1	55.2:1		1.6:1	16.9:1	86.6:1	
B1135.3STR	12.3/4	324	16.3/32	409	12.1/8	308	92.6	42	5/8	16	1	25	4.17/32	115	12.3/4	324	9 x 1/2 SH	9 x 12 SH	1:1	10.8:1	55.2:1		1.6:1	16.9:1	86.6:1	
B1135.3TR	12.3/4	324	16.3/32	409	11.17/32	293	77	35					4.17/32	115	12.3/4	324	9 x 1/2 SH	9 x 12 SH	1:1	10.8:1	55.2:1		1.6:1	16.9:1	86.6:1	
B1235.3STR	12.3/4	324	16.3/32	409	12.1/8	308	101.4	46	5/8	16	1	25	4.11/16	119	12.3/4	324	9 x 1/2 SH	9 x 12 SH	1:1	9.4:1	48.1		1.6:1	14.7:1	74.3:1	
B1335.3STR	12.3/4	324	16.5/16	414	13.7/16	342			5/8	16	1	25	6	153	14.9/16	370	11 x 1/2 SH	11 x 12 SH	2.3:1	8:1	38.2:1		3.7:1	12.5:1	59.9:1	
B1140.3STR	14.3/16	360	22.1/8	562	18.3/16	462	249.2	113	5/8	16	1	25	8.11/32	212	18.1/8	460	8 x 1/2 SH	8 x 12 SH	2.9:1	11.6:1	42.6:1		4:1	16.4:1	60.1:1	
B1145.3STR	14.1/4	362	21.3/16	538	16.1/2	419	192.9	87.5	5/8	16	7/8	22	8.3/16	208	17.3/4	450	14 x 1/2 SH	14 x 12 SH	2.9:1	11.9:1	53.6:1		4.1:1	16.6:1	75.6:1	
B1145.3TR	14.1/4	362	21.3/16	538	16.1/2	419	187.1	84.9	3/4	19	1.1/4	32	8.3/16	208	17.3/4	450	14 x 1/2 SH	14 x 12 SH	2.9:1	11.9:1	53.6:1		4.1:1	16.6:1	75.6:1	

Product not stocked. Contact Harken to request quote and lead time. *4 Speed option available. Contact Harken. †Available in electric. ‡Available in electric or hydraulic.





Air Winches

Harken Air winches feature interchangeable gearing sets that give crews the flexibility to create a perfect blend of speed and power for each day's weather and crew configuration. The winches, which feature a nearly empty middle to reduce weight, are designed to be used on SailGP foiling cats, IMOCA 60s, AC75s, TP52s, RC44, and other large Grand Prix boats.

The Air winch's hollow middle is a first for sailing winches, as are the changeable gear kits. All Harken Air winch models feature interchangeable first-speed and second-speed options. The wide-diameter drums allow fewer wraps, faster trimming, and faster easing. Standard and counter-rotating versions are available. The winches have a low-profile design. Available in six models: 180, 250, 300, 550, 600 and 900.

The 180 is the smallest of the Air winches and is appropriate for 12-14 m (40-48') boats. The 250 and 300 models are designed for boats up to 17 m (56'). The 550 and 600 models are designed for boats up to 24.4 m (80') and the 900 is made for boats over 24.4 m (80'). The 250 and 550 feature a high-performance, ceramic-coated white drum. The 300 and 600 feature an anodized aluminum drum, and the 900 drum is made of aluminum with a carbon fiber skirt.

The 250 and 550 are designed for new builds and are mounted in a unique way: the base of the winch is molded into the deck by the boatbuilder. The 300, 600, and 900 have a standard winch base that can be mounted on either new builds or retrofits.

The 250 and 550 Air winches are exclusively pedestal or handle driven. The rest of the models may be driven by pedestal, handle, or powered by electric or hydraulic motor.

Product not stocked. Contact Harken to request quote and lead time.



▶ Check out what RC44 trimmers say about Air Winch 180s



Air winch 180



Air winch 250
Air winch 550



Air winch 300
Air winch 600



Air winch 900



RC44 © Max Ranchi

Part No.	Ø Drum		Ø Base		Height		Weight		Line Ø			Line entry height		Fastener circle		Fasteners	Gear ratio			Power ratio			
	in	mm	in	mm	in	mm	lb	kg	Min	Max	in	mm	in	mm	in		mm	1	2	3	1	2	3
Air winch 180	6 7/8	175	9 1/32	229	5 19/32	142	14.1	6.4	3/16	5	3/8	10	1 15/16	50			1.38:1	6.51:1	17.24:1	4.01:1	18.89:1	50.04:1	
Air winch 250	7 7/8	200	10 21/32	271	5 3/4	146	16.1	7.3	3/16	5	3/8	10	1 15/16	50			1.34:1	6.40:1	25.42:1	3.42:1	16.27:1	64.57:1	
Air winch 300	7 7/8	200	10 21/32	271	6	153	17.0	7.7	3/16	5	3/8	10	2 1/4	57	8 9/32	210	5 x M8	1.34:1	6.40:1	25.42:1	3.42:1	16.27:1	64.57:1
Air winch 550	11 13/16	300	14 15/16	380	6 7/8	174	27.3	12.4	1/4	6	1/2	12	2 7/16	61			1.30:1	10.58:1	47.98:1	2.21:1	17.92:1	81.25:1	
Air winch 600	11 13/16	300	14 15/16	380	7 3/16	182	32.6	14.8	1/4	6	1/2	12	2 3/4	69	12 13/16	325	7 x M10	1.30:1	10.58:1	47.98:1	2.21:1	17.92:1	81.25:1
Air winch 900	14 3/8	365	18 1/8	460	10 1/8	257	70.6	32	3/8	10	7/8	22	3 5/8	92	16 7/16	417	10 x M12	3.12:1	13.11:1	67.17:1	4.34:1	18.25:1	93.48:1

Racing Pedestals

Racing pedestals allow crew members to trim from powerful standing positions. Customized to meet each yacht's requirements, these pedestal systems can be linked together, allowing crew to work in tandem to produce more power for faster, more efficient maneuvers.

Belt-Drive Pedestals

Harken belt-drive pedestals are molded from carbon fiber and epoxy. Prepreg lamination and autoclave curing maximize stiffness and strength. Components are made of hardcoat-anodized aluminum and 17-4 PH stainless steel. Roller bearings, thermoplastic belt sprockets, and carbon-fiber reinforced drive belts result in the lowest possible weight.

Belowdeck belt-drive pedestals are also offered in above deck/mid-drive styles. These pedestals can be removed and winches converted to manual operation to make more room in the cockpit during a long-distance race or cruise.

MX Pedestals

Harken MX carbon pedestals drive winches on small Grand Prix racers like GP42s, GP52s and Open 60s. The patented overdrive system features two chains inside the pedestal, eliminating the weight of an external overdrive box. Two drive sprockets allow trimmers to select the gear ratio, switching between the 1:1 direct-drive and the fast 1:3 drive chain without reversing grinding directions.



Pedestal handles

Pedestal handles are offered in aluminum or carbon fiber and in single, double, or SpeedGrip styles.

A SpeedGrip pedestal handle is a great solution for solo sailors because it frees up a hand for another task. SpeedGrip winch handles can be special-ordered from Harken.

MX PEDESTAL

MX pedestal

The red shaft of the left button indicates the 1:3 overdrive is engaged. Every turn of the handle produces three turns of the winch.

MX drive sprockets



1:3 chain engaged 1:1 chain engaged

BELT-DRIVE PEDESTALS



Twisted

Twisted belt-drive pedestals eliminate the weight of the 90° gear box when the grinder faces fore and aft.

Straight

A disconnect lever for an above-deck/mid-drive belt pedestal system is available.

Angled

An angled pedestal is customized to optimize the deck layout or tailored to the grinder for maximum comfort.

Air pedestal

The athwartship-mounted Air pedestal has a sculpted hole in the middle, with each leg shaped like a wing—the ultimate in drag reduction.

Wing pedestal

The Wing pedestal mounts fore and aft. It's extremely narrow aerodynamic shape dramatically reduces drag.

Product not stocked. Contact Harken to request quote and lead time.

Racing Pedestal Drive Components

Gear Boxes

The bevel gearbox is the basic building block of belt-drive pedestal systems. The B606 gear box is designed for up to a six-man, three-pedestal input.

Gearbox housings are CNC-machined from a solid piece of aluminum, hardcoat-anodized for strength and durability. Gears, shafts, and rollers are 17-4 PH stainless steel and are lubricated in a sealed oil bath for minimal maintenance.

Drive Shafts

Harken offers two types of drive shafts. Extruded, splined, aluminum drive shafts may be cut to length. Carbon tubular drive shafts are available with bonded end fittings for U-Joints or spherical CV-Joints. Shaft choice is determined by load, cost, and weight considerations. Your Harken representative can provide details on the best drive shaft for your boat.

Disconnects

System disconnects can be activated with either levers and control lines for hand operation, or a two-position push button for foot activation. The Harken foot button has fewer than 10 components, compared to almost 100 in other buttons, minimizing the possibility of losing or breaking parts. Foot button tops come in red, black, or blue to distinguish functions above deck.

Support Shafts

To space and support a gearbox beneath a winch, Harken supplies tubes for the B404, B606, and B808 series gearboxes. Tubes are made to length from carbon fiber/epoxy with bonded aluminum ends.



B606

404 gear box



808 gear box



Foot button disconnect



Universal Joint



Drive shafts

The 404 gearbox is designed for the TP52 Class. It allows for the power of as many as four crew members using two pedestals to be applied to a single winch drum. The 404 is a small, light and highly efficient bevel box. The 808 gear box is designed for boats with four or more pedestals on board. It allows for the power of as many as eight crew members. Both the 404 and 808 gearboxes are oil-bath lubricated and have inspection windows.



Carbon wheel

Y-box & carbon fiber spinnaker retrieval system

Pedestal-driven, belowdeck carbon wheel ensures high-speed spinnaker retrieval. Optional carbon T-box brackets and cantilevered gearbox brackets hold gearbox in position belowdeck; customized to boat.

T-box bracket

Cantilevered gearbox bracket

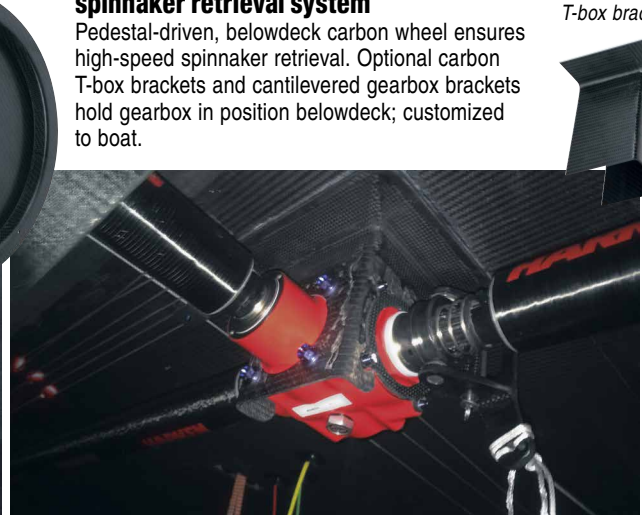

Product not stocked. Contact Harken to request quote and lead time.

Accessories: Carbo OneTouch® Locking Winch Handle

Lightweight and fast-acting, the Carbo OneTouch ball bearing locking winch handle makes grinding winches easy! Racers will maneuver faster and cruisers will have confidence in a reliable and easy-to-use winch handle.

The Carbo OneTouch locks in and out of the winch using its patented locking mechanism and ergonomically-designed grab bar. It only takes one hand to set or release the handle—squeeze anywhere along the grab bar with your palm to unlock; release the bar for a secure lock.

Harken added SpeedGrip handle technology to the OneTouch for fast and efficient winching. Its independent swivel between the ball bearing knob and hand-grip allows fast trimming using the palm for low-loads, and powerful two-handed grinding when loads are high.

At just 590 g (20.8 oz), the Harken Carbo OneTouch is built to be strong but lightweight. The grab bar and main handle are made of the same tough material as our Carbo block line: high-strength, fiber-reinforced composite, UV-stabilized for excellent protection against long-term exposure to saltwater and sun. The handle and grab bar are cross-ribbed and braced for enhanced stiffness.

An aluminum grip rod mates seamlessly to a forged aluminum handle insert to manage bending stresses. The black hardcoat-anodized octagonal drive gear is also integrated into the molding process, resulting in an extremely strong, one-piece structure. Its locking pins are tough 316 marine-grade stainless steel.



OneTouch is a registered trademark of Donald J. Steiner.



© Melges / Hannah Lee Noll



Molded urethane knob for comfortable feel and better grip when palming the handle.

Handle features an independent swivel between the knob and handle to keep the wrist straight and arms in the best power position while grinding.

B10HOT



The patented locking mechanism features two stainless steel pins that automatically retract when the handle's full-length grab bar is squeezed, and extend when it is released for a solid, secure lock.

Part No.	Description	Length (A)		Height (B)		Rise (C)		Weight	
		in	mm	in	mm	in	mm	oz	g
SpeedGrip									
B10HOT	Lock-in/Carbo OneTouch	9 1/2	241	7 1/8	181	1 5/16	33	20.8	590

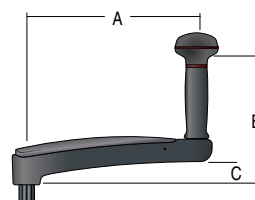

Accessories: Aluminum, Chrome and Bronze Handles



▶ Winch handle lock repair



These robust low-friction ball bearing handles match a range of cranking needs for both racers and cruisers. Handles feature a ball bearing grip that efficiently transmits power into the winch. All handles fit international standard winch sockets.

Locking vs. Plain

Lock-in handles are easy to engage and release with a thumb switch. Racers prefer plain handles because they are faster to insert.

Handle Length

254 mm (10") is the most comfortable handle length for most sailors. Published power ratios are based on this length.

203 mm (8") handles grind faster because they swing through a smaller circle, but power is reduced by 20%. 203 mm (8") handles are ideal for smaller boats and light air where speed is more important than power.

SpeedGrip

SpeedGrip handles are designed for the serious racer and are effective in both light and heavy air conditions. The unique grip permits low-load fast cranking using the palm, and powerful two-handed grinding when loads are high. The low-profile B8ASGLP is made for fast one-handed cranking where speed is the concern, not power.



Molded urethane knob for comfortable feel and better grip when palming the handle.

Handles feature an independent swivel between the knob and handle to keep the wrist straight and arms in the best power position while grinding.

The 254 mm (10") B10ADL handle features a lock-in switch and provides powerful two-handed grinding.



SPEEDGRIP

STANDARD

Part No.	Description	Length (A)		Height (B)		Rise (C)		Weight	
		in	mm	in	mm	in	mm	oz	g
SpeedGrip									
B8ASGLP	Lock-in/low-profile/aluminum	8	203	4 13/16	122	1 1/4	32	14.1	400
B8ASG	Lock-in/aluminum	8	203	7 3/16	182	1 1/4	32	17.6	500
B8CSG	Lock-in/chrome	8	203	7 3/16	182	1 1/4	32	35.3	1000
B10ASG	Lock-in/aluminum	10	254	7 7/16	188	1 1/2	38	21.2	600
B10CSG	Lock-in/chrome	10	254	7 7/16	188	1 1/2	38	47.6	1350
Standard									
B8AP	No-lock/aluminum	8	203	6 5/8	168	1 1/4	32	14.1	400
B8AL	Lock-in/aluminum	8	203	6 5/8	168	1 1/4	32	14.1	400
B8BL	Lock-in/bronze	8	203	6 5/8	168	1 1/4	32	31.7	900
B8CL	Lock-in/chrome	8	203	6 5/8	168	1 1/4	32	31.7	900
B10AP	No-lock/aluminum	10	254	7	178	1 1/2	38	17.6	500
B10AL	Lock-in/aluminum	10	254	7	178	1 1/2	38	17.6	500
B10BL	Lock-in/bronze	10	254	7	178	1 1/2	38	45.9	1300
B10CL	Lock-in/chrome	10	254	7	178	1 1/2	38	45.9	1300
B10ADL	Lock-in/double-grip/aluminum	10	254	11 1/4	286	1 13/16	46	21.2	600

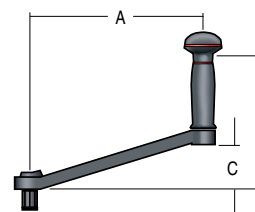

Accessories: Service Kits

You should service your winches at least once during the preseason. However, twice a season is best if your boat lives in salt water. If you race your boat hard, you may want to maintain your winches before every regatta. Keep your winches clean and operating smoothly by flushing frequently with fresh water. Check pawls and springs, bearings, gears, and spindles for signs of wear and corrosion.

For more details, consult the maintenance manual.

Installation manuals and parts lists are available online at www.harken.com.



BK4514



BK4521



BK4513



Radial winch



Classic winch

WINCH Q&A

WHICH PARTS DO I GREASE AND WHICH DO I OIL ON MY HARKEN WINCHES?

Grease all metal gears and roller bearings with Harken Winch Grease. It's highly resistant to salt and fresh water, works in all temperatures, and protects against corrosion. NEVER grease pawls or springs because grease causes them to stick. Instead, lubricate with Harken Pawl Oil for optimal rotation. Radial winches and carbon winches have composite roller bearings that do not need to be lubricated.



BK4512



BK4515
BK4516



BK4517



BK4518



BK4519

Part No.	Description	Includes	Fits winches			
			Radial	Performa	Classic	Custom/Racing*
BK4512	Winch service kit	10 pawls, 20 springs	2-speed: 15 - 70.2, Rewind, UniPower	20	B6 - B980	1000.3
BK4513	Winch grease	100 ml tube				
BK4514	Winch service case	10 pawls, 20 springs, pawl oil, winch grease, handle repair kit, stickers	2-speed: 15 - 70.2, Rewind, UniPower	20	B6 - B980	1000.3
BK4515	Racing winch service kit/10 mm	10 17-4 PH pawls, 20 springs	80	80		880 - 1150
BK4516	Racing winch service kit/8 mm	10 17-4 PH pawls, 20 springs	60.3, 70.3	35 - 70, Quattro		50 - 650, Air® winches
BK4517	Lock-in handle repair kit	Lock-in knob, spring pin, lock-in spring, isolator, lock-in plate		All handles		
BK4518	Winch drum screw kit	8 screws 8 mm x 20 mm, 8 plastic washers			B48 - B980	
BK4519	Winch drum screw kit	8 screws 8 mm x 20 mm, 8 plastic washers			B16 - B46	
BK4521	Pawl oil for pawls and springs					

*Custom and racing winch service kits might not include all the pawls needed. Please contact Harken.

Captive Reel Winches

Electric & Hydraulic

Harken captive reel winches represent a leap forward in captive winch design. The result of years of intense development at Harken Italy's dedicated facility, captive winches are offered in more sizes than ever, with pulling loads of 1.5 to 70 tons, and for boats from 45 feet and up. All sizes are offered with electric or hydraulic motors. Harken's latest captive winches don't just offer an impressive line speed when hauling in—they can ease a line just as quickly and safely when rapid response is needed. Robust and compact, these belowdeck winches keep topsides clear for a clean, uncluttered look. Use for remote line handling: raise/lower halyard, trim/ease mainsheet—all at the touch of a button or a nudge of a joystick for even more fine-tune line speed or trimming control.

Jeanneau 64, 20.1 m (65'11") Philippe Briand design © David Clapp Photography Ltd / Jeanneau



Air Captive

When the application makes them appropriate, our new Air captive winches provide the highest performance-to-weight ratio we've ever achieved in a captive reel winch. For the same pulling capacity and speed, Air captives weigh approximately 50% of our general-purpose models. To achieve these weight savings, they employ smaller diameter drums which are significantly lighter. The trade-off is that less line stays on those drums so they are best suited to applications where less line capacity is required—for instance sail controls or board activations rather than sheets. Importantly, this new design also requires application where the line can enter the line feeder from the front of the winch. This delivers less load to the feeder so that the feeder can be built lighter as well. Plus, the necessary mounting structure can be achieved without the weight of a baseplate. Currently, Air captives are hydraulically driven in 9, 13.5, and 16 ton pulling capacities. Additional sizing and power options are in development.



Power/Sheet Size Guide

Part No.	Maximum dynamic pull		Maximum holding load		Line Ø Min		Line Ø Max		Maximum pressure		Flow rate		Max line speed	
	lb	kg	lb	kg	in	mm	in	mm	PSI	bar	gal/min	L/min	ft/min	m/min
9T	19842	9000	29762	13500	.55	14	.87	22	3916	270	18.5	70	280.8	85.6
13.5T	29762	13500	34833	15800	.55	14	.87	22	5221	360	21.1	80	279.9	85.3
16T	35274	16000	41888	19000	.63	16	1.1	28	3191	220	31.7	120	224.5	68.5

Hydraulic Motors

Part No.	Maximum dynamic pull		Maximum holding load		Line Ø Min		Line Ø Max		Maximum pressure		Flow rate		Max line speed	
	lb	kg	lb	kg	in	mm	in	mm	PSI	bar	gal/min	L/min	ft/min	m/min
9T	19842	9000	29762	13500	.55	14	.87	22	3916	270	18.5	70	280.8	85.6
13.5T	29762	13500	34833	15800	.55	14	.87	22	5221	360	21.1	80	279.9	85.3
16T	35274	16000	41888	19000	.63	16	1.1	28	3191	220	31.7	120	224.5	68.5

Product not stocked. Contact Harken to request quote and lead time.

9T Active Line Storage

Captive length size	Line Ø 14 mm		Line Ø 16 mm		Line Ø 18 mm		Line Ø 20 mm		Line Ø 22 mm	
	ft	m	ft	m	ft	m	ft	m	ft	m
530	39.0	11.9	34.5	10.5	31.5	9.6	27.9	8.5	25.9	7.9
630	55.8	17.0	48.9	14.9	44.9	13.7	39.3	12.0	36.7	11.2
730	69.2	22.1	63.6	19.4	58.4	17.8	51.2	15.6	47.9	14.6
830	88.9	27.1	78.1	23.8	71.9	21.9	63.0	19.2	58.7	17.9
930	105.6	32.2	92.8	28.3	85.3	26.0	74.8	22.8	69.9	21.3
1030	122.0	37.2	107.3	32.7	98.7	30.1	86.6	26.4	80.7	24.6

13.5T Active Line Storage

Captive length size	Line Ø 14 mm		Line Ø 16 mm		Line Ø 18 mm		Line Ø 20 mm		Line Ø 22 mm	
	ft	m	ft	m	ft	m	ft	m	ft	m
580	47.6	14.5	41.7	12.7	38.4	11.7	33.8	10.3	31.5	9.6
630	55.8	17.0	48.9	14.9	44.9	13.7	39.3	12.0	36.7	11.2
730	69.2	22.1	63.6	19.4	58.4	17.8	51.2	15.6	47.9	14.6
830	88.9	27.1	78.1	23.8	71.9	21.9	63.0	19.2	58.7	17.9
930	105.6	32.2	92.8	28.3	85.3	26.0	74.8	22.8	69.9	21.3
1030	122.0	37.2	107.3	32.7	98.7	30.1	86.6	26.4	80.7	24.6

16T Active Line Storage

Captive length size	Line Ø 16 mm		Line Ø 18 mm		Line Ø 20 mm		Line Ø 22 mm		Line Ø 24 mm		Line Ø 26 mm		Line Ø 28 mm	
	ft	m	ft	m	ft	m	ft	m	ft	m	ft	m	ft	m
830	87.9	26.8	78.7	24.0	71.9	21.9	64.6	19.7	62.7	19.1	58.1	17.7	53.2	16.2
930	106.3	32.4	95.1	29.0	86.6	26.4	78.1	23.8	75.8	23.1	69.9	21.3	64.3	19.6
1130	143.0	43.6	128.0	39.0	116.5	35.5	105.3	32.1	101.7	31.0	94.2	28.7	86.6	26.4
1330	179.4	54.7	160.8	49.0	146.3	44.6	132.2	40.3	128.0	39.0	118.4	36.1	108.6	33.1

Captive Reel Winches: 1.5 - 3T

Once the domain of only the largest yachts, a new wave of captive winch design and technology has provided the catalyst for the development of winches for boats in the 14 m -18 m (45'- 60') range. Robust and compact, these belowdeck winches keep topsides clear for a clean, uncluttered look. Use for remote line handling: raise/lower halyard, trim/ease mainsheet—all at the touch of a button.

The winch frame and drum are 6061-T6 hardcoat-anodized aluminum. All parts connected to hydraulic or electrical circuitry are positioned on the same side for maintenance. The screw bearings and gear transmission are also located on this side for easy inspection. Bearings are self-lubricated. The main gearbox is sealed and lubricated with oil.

Electric Versions

Electric captives in 1.5-ton and 3-ton sizes come standard with 12-volt or 24-volt power. The 3T version is also available with a 24-volt high-speed (HS) motor. The winch has a single gear and is managed with push buttons for trimming and easing. A mechanical switch limits the stroke of the feeder to prevent overrides. Winches include a dual-function control box with a built-in load controller that combines two products into one, reducing wiring and connection points by almost half and greatly simplifying installation. The dual-function control box supports the Digital System Switch or analog switches. A mix of switches is not supported.

Hydraulic Versions

Hydraulic 1.5-ton and 3-ton captive winches are driven by industrial-sealed, fixed-displacement motors. The synchronized transmission uses two gear sets (four gears) to drive the twin feeder screws. To change line diameter, the gear sets must be replaced. The feeder transmission's twin feeder screws balance the load on the feeder, allowing line to lie smoothly on the drum—even when slack.



The screw design positions the screw close to the drum, reducing winch size.

Electric Part Numbers

1.5T42012RH EL12

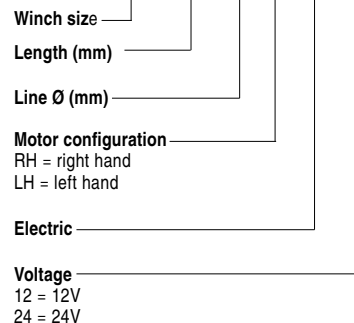

Harken 1.5T and 3T captive winches are offered with an optional built-in 90-degree line feeder for installation where space is limited.

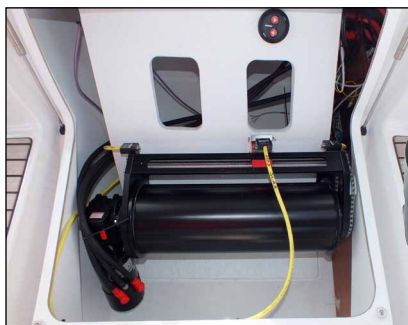

ELECTRIC



HYDRAULIC

Power/Sheet Size Guide

Part No.	Maximum dynamic pull		Maximum holding load		Min	Line Ø		Max
	lb	kg	lb	kg		in	mm	
1.5T	3300	1500	5500	2500	1/2	12	3/4	18
3T	6600	3000	11000	5000	1/2	12	3/4	18

Loads and converted sizes are guides only. Winches are customized to application. Hydraulic captive reel winches can be driven by different displacement motors. Contact Harken for max pressure details. For line storage lengths see page 231.

Electric Motors

Part No.	Max line speed		Max current amps	Control box	Circuit breaker
	ft/min	m/min			
1.5T 12V	39.4	12.0	340	Dual-Function Control Box	HCP1718
1.5T 24V	42.7	13.0	150	Dual-Function Control Box	HCP1717
3T 24V	42.7	13.0	250	Dual-Function Control Box	—
3T 24V HS	164.1	50.0	230	Motor driver	HCP1720

Hydraulic Motors

Part No.	Max pressure		Flow rate		Max line speed	
	PSI	Bar	gal/min	L/min	ft/min	m/min
1.5T	1739	120	13	50	115.9	35.0
3T	2753	190	13	50	99.3	30.0

Product not stocked. Contact Harken to request quote and lead time.

Captive Reel Winches: 6 - 70T

Captive winches are offered with pulling loads up to 70 tons with both hydraulic and electric drives for boats from 18 m (60') to the largest megayachts. Drum lengths vary to fit individual project requirements. Captives and tensioners are tested at full load before shipping.

The winch frame and drum are 6061-T6 hardcoat-anodized aluminum with a carbon-fiber gear cover to reduce weight. All parts connected to hydraulic or electrical circuitry are positioned on the same side for maintenance. The screw bearings and gear transmission are also located on this side for easy inspection. Bearings are sealed and lubricated with grease. The main gearbox is sealed and lubricated with oil.

Electric Versions

6T winches and larger run off 500-800V DC systems or 400V AC 3-phase supply. Electric motors on winches 9T and higher are customized for the application. The winch has a single gear and is managed with a joystick for trimming and easing. A gear-and-chain transmission drives the feeder screw, allowing the line to lie smoothly on the drum in a single layer. Tapping into the larger battery banks on modern yachts allows the use of electric captives in sizes previously only available in hydraulic. This provides a quieter, more efficient system. Harken has also developed an innovative push/pull captive that allows a single winch and motor to take the place of two.

Hydraulic Versions

Hydraulic winches 6T and up are offered with variable-speed motors. Custom solutions are available for higher loads. The synchronized transmission uses two gear sets (four gears) to drive the twin feeder screws. To change line diameter, the gear sets must be replaced. The feeder transmission's twin feeder screws balance the load on the feeder, allowing line to lie smoothly on the drum—even when slack. The double screw design positions the screws close to the drum, reducing winch size over similarly configured winches. The tensioner system keeps a constant load on the line to prevent overrides.



Hydraulic versions have an open-ended design to reduce weight.



Designed for easy maintenance.



Self-lubricating feeder screw and sheave allow line to lie smoothly on the drum, even when slack.



Two inner magnetic switches factory-set at the feeder's stroke limits prevent overtravel. Two outer fail-safe limit switches automatically engage the brake.

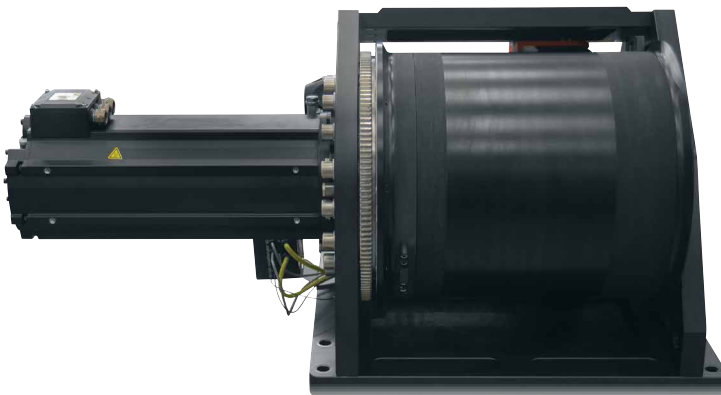

ELECTRIC



HYDRAULIC

Product not stocked. Contact Harken to request quote and lead time.

Captive Reel Winches: 6 - 70T



© Vitters Shipyard

Power / Sheet Size Guide

Part No.	Maximum dynamic pull		Maximum holding load		Min	Line Ø		Max
	lb	kg	lb	kg		in	mm	
6T	13200	6000	19800	9000	9/16	14	7/8	22
9T	19800	9000	26400	12000	5/8	16	1	26
12T	26400	12000	33000	15000	3/4	18	1 1/8	28
16T	35200	16000	41800	19000	1	24	1 1/4	32
18T	39700	18000	46307	21000	1	24	1 1/4	32
25T	55100	25000	66100	30000	1 1/4	32	1 1/2	40
35T	77175	35000	99225	45000	1 3/8	34	1 15/16	50
50T	110250	50000	132300	60000	1 9/16	40	2 9/16	66
70T	154350	70000	176400	80000	1 7/8	48	2 9/16	66

Product not stocked. Contact Harken to request quote and lead time. Loads and converted sizes are guides only. Winches are customized to application. Hydraulic captive reel winches can be driven by different displacement motors. Contact Harken for max pressure details. For line storage lengths see page 231.

Electric Motors

Part No.	Max line speed		Max current amps	Control box
	ft/min	m/min		
6T 24V HS	164.1	50.0	395	Motor driver
6T 48V HS	196.9	60.0	210	Motor driver
9T				
12T				
16T				
18T				
25T				
35T				
50T				
70T				

For sizes 9T and larger, electric motors are customized to the application. Contact Harken with project requirements for options.

Hydraulic Motors

Part No.	Max pressure		Flow rate		Max line speed	
	PSI	Bar	gal/min	L/min	ft/min	m/min
6T	3478	240	18	70	344.5	105.0
9T	3623	250	21	80	259.2	79.0
12T	3623	250	26	100	285.4	87.0
16T	3623	250	32	120	255.9	78.0
18T	4133	285	32	120	255.9	78.0
25T	4061	280	32	120	239.5	73.0
35T	4061	280	32	120	262.5	80.0
50T	4714	325	42	160	295.3	90.0
70T	5076	350	53	200	262.5	80.0

Line speeds can vary with each winch and power configuration.

Captive Reel Winches

Active Line Storage

Captive Length Size	Line Ø 12 mm		Line Ø 14 mm		Line Ø 16 mm		Line Ø 18 mm	
	mm	ft m	ft m	ft m	ft m	ft m	ft m	ft m
1.5T								
420	49.3	14.9	43.9	13.4	39.1	11.8	33.8	10.2
520	66.5	20.1	59.4	18.1	53.0	16.0	45.7	13.8
3T								
420	49.3	14.9	41.4	12.5	39.1	11.8	33.8	10.2
520	66.5	20.1	55.9	16.9	53.0	16.0	45.7	13.8
720	101.3	30.6	85.1	25.7	80.1	24.2	69.5	21.0
920	134.5	41.0	113.0	34.5	106.6	32.5	92.2	28.1
1120	169.0	51.5	142.0	43.3	133.9	40.8	115.8	35.3

Captive Length Size	Line Ø 14 mm		Line Ø 16 mm		Line Ø 18 mm		Line Ø 20 mm		Line Ø 22 mm	
	mm	ft m	ft m	ft m	ft m	ft m	ft m	ft m	ft m	ft m
6T										
810	70.2	21.2	61.6	18.6	56.6	17.1	49.3	14.9	46.0	13.9
1010	110.9	33.5	97.3	29.4	89.4	27.0	78.1	23.6	72.8	22.0
1210	151.6	45.8	133.1	40.2	122.1	36.9	106.9	32.3	99.6	30.1
1410	192.3	58.1	168.8	51.0	154.9	46.8	135.7	41.0	126.4	38.2

Captive Length Size	Line Ø 16 mm		Line Ø 18 mm		Line Ø 20 mm		Line Ø 22 mm		Line Ø 24 mm		Line Ø 26 mm	
	mm	ft m	ft m	ft m	ft m	ft m	ft m	ft m	ft m	ft m	ft m	ft m
9T												
930	108.2	32.7	96.7	29.2	88.0	26.6	79.1	23.9	76.5	23.1	70.5	21.3
1130	155.6	47.0	139.0	42.0	127.1	38.4	114.5	34.6	110.6	33.4	101.6	30.7
1330	204.2	61.7	182.4	55.1	166.2	50.2	149.6	45.2	144.6	43.7	133.1	40.2
1530	252.2	76.2	225.4	68.1	205.2	62.0	185.0	55.9	178.7	54.0	164.5	49.7
1730	300.2	90.7	268.1	81.0	244.3	73.8	220.1	66.5	212.8	64.3	195.6	59.1

Captive Length Size	Line Ø 18 mm		Line Ø 20 mm		Line Ø 22 mm		Line Ø 24 mm		Line Ø 26 mm		Line Ø 28 mm	
	mm	ft m	ft m	ft m	ft m	ft m	ft m	ft m	ft m	ft m	ft m	ft m
12T												
1130	127.2	38.8	116.0	35.3	104.3	31.8	101.0	30.7	93.2	28.4	89.2	27.2
1330	168.3	51.3	153.2	46.7	138.1	42.1	134.0	40.7	123.4	37.6	118.1	36.0
1530	210.0	63.9	191.0	58.2	172.0	52.4	166.3	50.7	154.0	46.8	147.0	44.8
1730	251.0	76.5	229.0	69.7	206.0	62.8	199.0	60.6	184.0	56.0	176.0	53.6

Captive Length Size	Line Ø 24 mm		Line Ø 26 mm		Line Ø 28 mm		Line Ø 30 mm		Line Ø 32 mm	
	mm	ft m	ft m	ft m	ft m	ft m	ft m	ft m	ft m	ft m
16T										
1030	92.7	28.0	83.1	25.1	80.4	24.3	74.1	22.4	71.2	21.5
1330	150.9	45.6	135.4	40.9	130.7	39.5	120.5	36.4	115.9	35.0
1530	189.7	57.3	169.8	51.3	164.2	49.6	151.6	45.8	145.6	44.0
1730	228.1	68.9	204.6	61.8	197.6	59.7	182.4	55.1	175.4	53.0

Captive Length Size	Line Ø 24 mm		Line Ø 26 mm		Line Ø 28 mm		Line Ø 30 mm		Line Ø 32 mm	
	mm	ft m	ft m	ft m	ft m	ft m	ft m	ft m	ft m	ft m
18T										
1030	92.7	28.0	83.1	25.1	80.4	24.3	74.1	22.4	71.2	21.5
1330	150.9	45.6	135.4	40.9	130.7	39.5	120.5	36.4	115.9	35.0
1530	189.7	57.3	169.8	51.3	164.2	49.6	151.6	45.8	145.6	44.0
1730	228.1	68.9	204.6	61.8	197.6	59.7	182.4	55.1	175.4	53.0

Captive Length Size	Line Ø 32 mm		Line Ø 34 mm		Line Ø 36 mm		Line Ø 38 mm		Line Ø 40 mm	
	mm	ft m	ft m	ft m	ft m	ft m	ft m	ft m	ft m	ft m
25T										
1030	68.0	20.7	62.0	18.9	56.1	17.0	54.0	16.4	50.1	15.2
1330	114.0	34.7	104.0	31.6	94.0	28.5	90.2	27.5	83.3	25.4
1530	145.0	44.1	132.0	40.1	118.4	36.1	114.1	34.8	106.0	32.2
1730	175.1	53.4	159.4	48.6	143.3	43.7	138.4	42.2	128.0	39.0
1930	206.0	62.7	187.3	57.1	169.0	51.4	163.0	49.6	150.3	45.8

Captive Length Size	Line Ø 34 mm		Line Ø 36 mm		Line Ø 38 mm		Line Ø 40 mm		Line Ø 42 mm	
	mm	ft m	ft m	ft m	ft m	ft m	ft m	ft m	ft m	ft m
35T										
1330	81.4	24.4	87.4	26.6	81.6	24.8	76.0	23.1	70.5	21.4
1530	121.3	36.9	113.7	34.6	106.1	32.3	98.9	30.1	91.7	27.9
1730	149.3	45.5	140.0	42.6	130.6	39.8	121.8	37.1	112.9	34.4
1930	177.3	54.0	166.2	50.6	155.2	47.2	144.7	44.0	134.1	40.8
2130	201.1	61.3	188.6	57.4	176.0	53.6	164.1	50.2	153.7	46.3
2330	233.4	71.1	218.8	66.9	204.2	62.2	190.4	58.0	176.5	53.7

Captive Length Size	Line Ø 40 mm		Line Ø 42 mm		Line Ø 46 mm		Line Ø 50 mm		Line Ø 54 mm	
	mm	ft m	ft m	ft m	ft m	ft m	ft m	ft m	ft m	ft m
50T										
1670	128.0	39.0	119.8	36.5	111.9	34.1	104.3	31.8	96.5	29.4
1870	162.1	49.4	151.9	46.3	142.1	43.3	132.2	40.3	122.4	37.3
2070	196.5	59.9	183.7	56.0	172.2	52.5	160.4	48.9	148.3	45.2
2270	231.0	70.4	215.9	65.8	202.1	61.6	188.3	57.4	174.2	53.1
2470	265.1	80.8	248.0	75.6	232.3	70.8	216.2	65.9	200.1	61.0
2670	299.5	91.3	280.2	85.4	262.5	80.0	244.4	74.5	226.0	68.9
2870	334.0	101.8	312.3	95.2	292.7	89.2	272.3	83.0	252.0	76.8
3070	368.1	112.2	344.5	105.0	322.5	98.3	300.5	91.6	277.9	84.7

Captive Length Size	Line Ø 48 mm		Line Ø 52 mm		Line Ø 56 mm		Line Ø 60 mm		Line Ø 64 mm	
	mm	ft m	ft m	ft m	ft m	ft m	ft m	ft m	ft m	ft m
70T										
1670	117.5	35.8	109.9	33.5	102.7	31.3	95.5	29.1	88.3	26.9
1870	150.9	46.0	141.1	43.0	131.9	40.2	122.7	37.4	113.5	34.6
2070	184.4	56.2	172.6	52.6	161.4	49.2	150.3	45.8	138.8	42.3
2270	217.9	66.4	203.7	62.1	190.6	58.1	177.5	54.1	164.0	50.0
2470	251.3	76.6	235.2	71.7	220.1	67.1	204.7	62.4	189.3	57.7
2670	285.1	86.9	266.7	81.3	249.3	76.0	232.0	70.7	214.6	65.4
2870	318.6	97.1	297.9	90.8	278.5	84.9	259.2	79.0	239.5	73.0
3070	352.0	107.3	329.4	100.4	308.1	93.9	286.4	87.3	264.8	80.7

Line storage lengths are guides only. Winches are customized to application. Product not stocked. Contact Harken to request quote and lead time.

Line Tensioners

Harken lightweight line tensioners are available with either electric or hydraulic power. They provide pull to prevent line slack and overrides. Both in-line and through-deck tensioners have powered belts encasing both sides of the line, doubling pull and grip capabilities compared to other versions on the market. Tensioner manifolds are independently plumbed and include a solenoid directional cartridge to optimize tensioner functions. The pay-out circuit includes a pressure-release valve to adjust tensioner pull force. The pay-in circuit includes a relief valve to control drag and to help prevent overrides.



CT0: IN-LINE TENSIONER

For use with our smallest, lightest captive reel winches from 1.5T-3T. Like our CT2 model, two independently-powered belts collaborate to keep the line well-managed. Available for hydraulic or 24-volt systems.



CT1: 90-DEGREE LINE TENSIONER

Use with winches from 3T to 9T. Sealed roller bearing sheave. Mounts above or belowdeck. Symmetrical for right hand/left hand mounting. Handle 80-degree to 120-degree line wraps.



CT2: IN-LINE TENSIONER

Use with winches from 3T to 25T. Two independently-powered rubber belts drive line off winch drum. Carbon-fiber cover keeps tensioner clean and safe.



CT3: 90-DEGREE THROUGH-DECK TENSIONER

Use with winches from 3T to 25T. 300 mm sandblasted sheave handles line load. Synchronized rubber belt adds additional grip. Stainless steel, anodized aluminum, or carbon cover. Waterproof sealed roller bearings.



CT5: 45-DEGREE THROUGH-DECK TENSIONER

Use with winches from 3T to 25T. 45° line deviation minimizes line stress at high loads. Stainless steel, anodized aluminum, or carbon cover. Waterproof sealed roller bearings.

CT4: 180-DEGREE THROUGH-DECK TENSIONER

Use with winches from 3T to 18T. 300 mm sandblasted sheave handles line load. Synchronized rubber belt adds additional grip. Stainless steel, anodized aluminum, or carbon cover. Waterproof sealed roller bearings.



CT6: 90-DEGREE THROUGH-DECK TENSIONER

Use with winches from 25T to 35T. 300 mm sandblasted sheave handles line load. Synchronized rubber belt adds additional grip. Stainless steel, anodized aluminum, or carbon cover. Waterproof sealed roller bearings.

CT7: 90-DEGREE THROUGH-DECK TENSIONER

Use with winches from 50T to 70T. 300 mm sandblasted sheave handles line load. Synchronized rubber belt adds additional grip. Stainless steel, anodized aluminum, or carbon cover. Waterproof sealed roller bearings.

Product not stocked. Contact Harken to request quote and lead time.



Ordering Winches

1. Choose Drum Material, Speed & Style

Aluminum: aluminum Radial winches in 1-, 2-, and 3-speed self-tailing or plain-top.

Aluminum classic single-speed, plain-top winches in sizes 6 and 8; 2- and 3-speed self-tailing winches sizes 980 and up in aluminum or aluminum/stainless.

Chrome: Chrome Radial winches feature chrome drums with black or white composite bases and tops; 1-, 2-, and 3-speed self-tailing.

All-chrome Radial winches have chrome bases, drums, and tops; 1-, 2- and 3-speeds; self-tailing or plain-top.

Stainless Steel: stainless steel winches have stainless bases, drums, and tops; 2-, and 3-speed self-tailing; 4-speed winches in some larger sizes.

Bronze: bronze Radial winches in 1-, 2-, and 3-speeds; self-tailing or plain-top styles.

Carbon Fiber: carbon fiber winches in 2- and 3-speed self-tailing or top-cleating.

To order large cruising, Megayacht, and Grand Prix racing winches, please contact Harken.

Powered Winches: choose electric or hydraulically driven winches and components. To order hydraulic winches, please contact Harken.

2. Determine size

The **Sizing Chart** selects winches for different applications and rig dimensions. If unsure of the dimensions, use the **Typical Dimensions** graphs. To order large Grand Prix and Megayacht winches, please contact Harken.

3. Choose Ball Bearing Handle

Plain or lock-in handles in chromed bronze, bronze, and aluminum; Speedgrip and standard styles in 203 and 254 mm (8 and 10") lengths.

Rig Dimensions

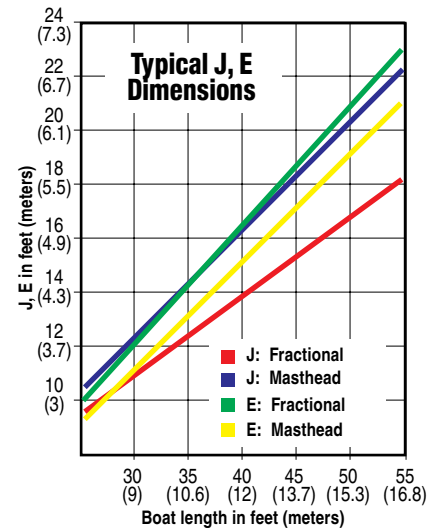
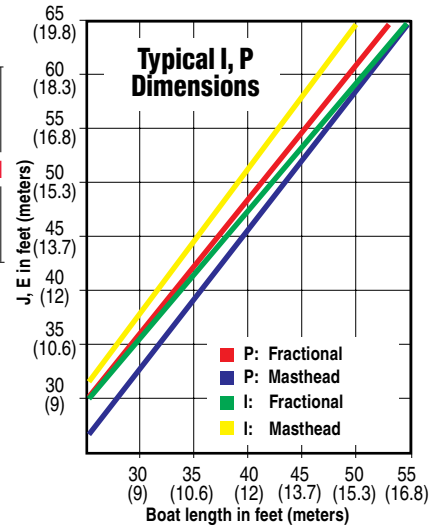
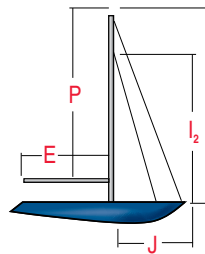

Sizing Chart

Winch size	Genoa				Mainsail						Spinnaker						Staysail	
	Sheet		Halyard		End-boom mainsheet		Halyard		Reef		Sheet		Halyard		Topping lift/foreguy		Halyard	
	Max sail area 100% foretriangle (l x J x .5)		Max I		4:1 sheet max sail area (P x E x .5)		Max P		Max P		Max sail area (l x J x 1.8)		Max I		Max I		Max I ₂	
	ft ²	m ²	ft	m	ft ²	m ²	ft	m	ft	m	ft ²	m ²	ft	m	ft	m	ft	m
6	75	7	25	7.6	—	—	25	7.6	34	10.4	500	46.5	25	7.6	35	10.7	25	7.6
8	115	10.5	36	11	150	14	32	9.8	40	12.2	800	74	36	11	44	13.4	37	11.3
15	135	12.5	39	12	194	18	34	10.5	43	13	893	83	39	12	47	14.2	39	12
20	155	14.5	42	12.8	230	21	38	11.6	46	14	975	91	42	12.8	50	15.2	42	12.8
35	225	21	48	14.6	335	30	43	13.1	53	16.2	1135	105	48	14.6	56	17	48	14.6
40	270	25	54	16.5	410	38	49	14.9	57	17.4	1240	115	54	16.5	61	18.6	54	16.5
46	365	34	69	21	625	58	64	19.5	73	22.2	1530	142	68	20.7	78	23.8	69	21
50	390	36	73	22.2	700	65	68	20.7	78	23.8	1750	162	74	22.5	82	25	73	22.2
60	525	49	82	25	850	79	80	24.4	92	28	2200	204	85	25.9	98	29.9	82	25
70	590	55	86	26.2	1000	93	85	25.9	97	29.6	3000	279	91	27.7	108	33	86	26.2
80	950	88	100	30.5	1350	125	102	31.1	—	—	—	—	105	32	—	—	—	—

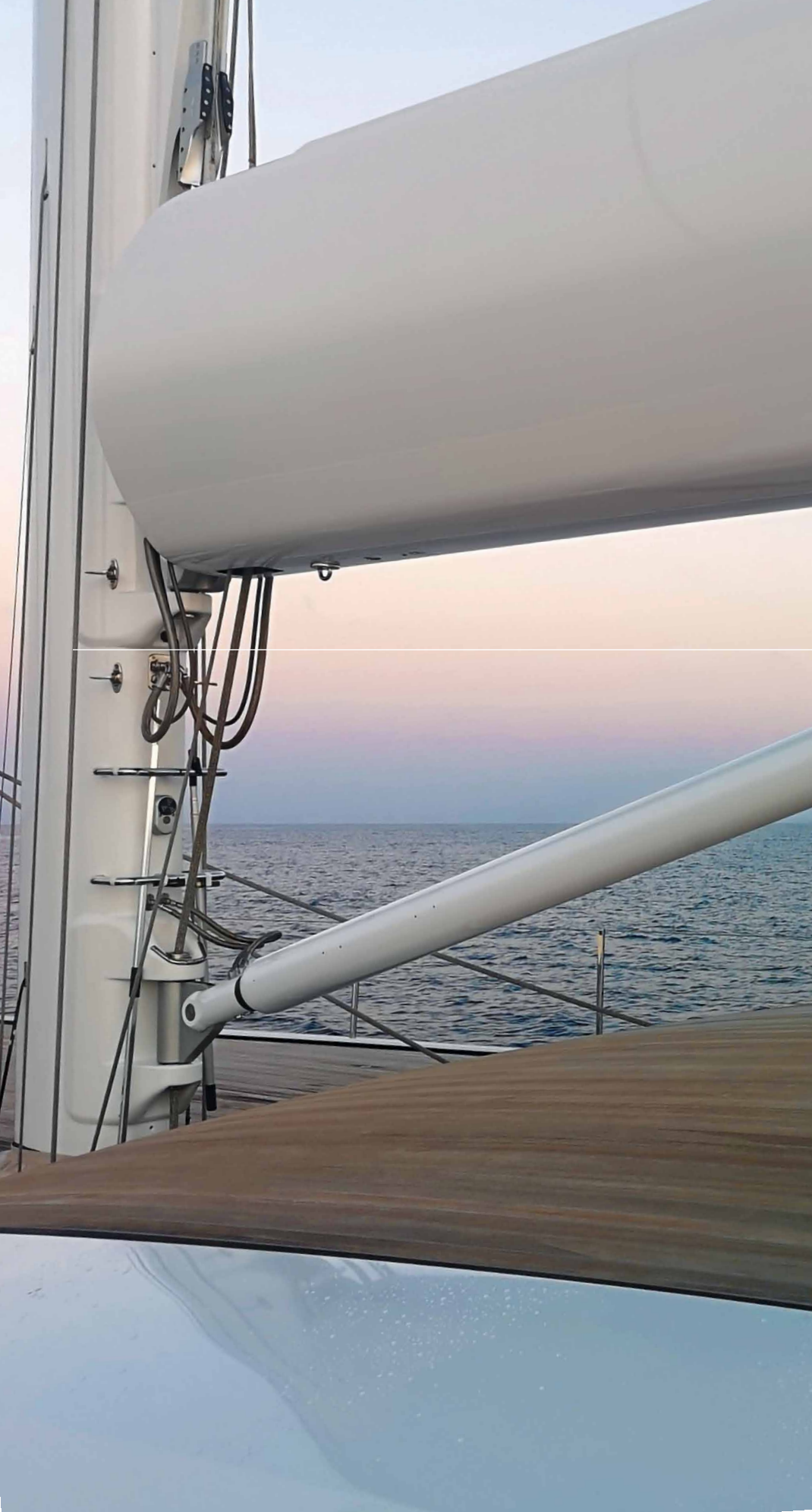

HYDRAULICS

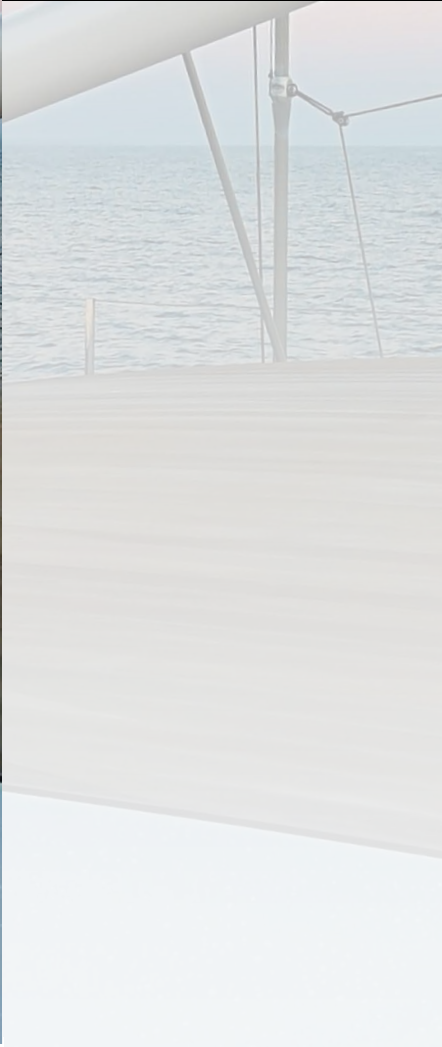

Single-Acting Integral Backstay Adjusters

Harken's integral hydraulic backstay adjuster provides the power to optimize sail shape quickly for racers and adjust mast tension for smoother furling for cruisers. The cylinder features a built-in, single-acting pump.

Every unit includes a hardcoat-anodized aluminum cylinder and pump, valve, and stainless pump handle with two attachment options:

1) a roll pin, that when installed, locks the handle permanently, 2) the roll pin can be left off and the handle may be inserted when needed, but stored separately. Cylinders include a clevis pin on both ends. A fiberglass position indicator attached to the top clevis pin slides down the cylinder as it's retracted for repeatable tension settings. Standard eye-jaw toggles fit all Harken cylinders and are recommended on all installations.

The pressure-release knob turns clockwise to close and pump, counterclockwise to release. When closing the pump, the knob cannot be over-tightened by hand, preventing damage to the valve. Release speed depends on how far open the knob is turned. Pressure relief is factory set to prevent crew from over-tensioning the backstay.

Harken integral backstay adjusters come in four sizes to fit boats 9 - 18 m (30 - 60') with stay diameters of 5 - 10 mm (7/32 - 3/8").



Harken recommends attaching a toggle to the cylinder's bottom clevis to accommodate stay movement. Standard eye-jaw toggles fit all Harken cylinders.



Supplied fiberglass position indicator provides easy visual reference to duplicate desired tension settings.

For replacement position indicator assembly, order part number H-85275.



Hey Jude, © Jean Treadwell

Part No.	- Size	Max wire Ø		Stroke		Pin center length (closed)*		Weight**		Gap/pin Ø		Pull force ‡	
		in	mm	in	mm	in	mm	lb	kg	in	mm	lb	kg
HCI006BCC	-6	7/32	5.5	14.17	360	30	762	8.36	3.79	7/16	11.1	3770	1710
HCI010BCC	-10	9/32	7	14.17	360	30	762	8.36	3.79	1/2	12.7	4710	2136
HCI012BCC	-12	5/16	8	14.17	360	30	762	9.72	4.41	5/8	15.9	6710	3043
HCI017BCC	-17	3/8	9.5	14.17	360	30	762	9.72	4.41	5/8	15.9	8390	3808

*For pin center length open (PCLO) add stroke length to pin center length closed. **Rod ends (forks) included in weights.

‡ Relief valves are preset to limit max tension (pull force) to recommend rigging loads and cylinder design limits. Each cylinder provides a specific max pull force.



Stay Away!, Solaris 55, 16.70 m (54.79'), Javier Soto Acebal design © Solaris Yachts



HYDRAULIC CYLINDERS

Harken offers a full range of hydraulic cylinders to handle mast, sail, and keel controls on cruising and racing yachts. Components are designed to reduce weight and size and to increase structural strength for years of high-stress use in corrosive marine environments. They are available in sizes -6 (25mm bore) to -195 (145mm bore) to fit everything from 9 m (30') racer/cruisers to 46 m (150')-plus megayachts. Harken-certified service centers can be found in countries around the world.

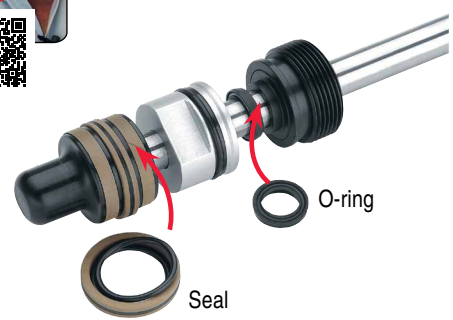

Materials:
For properties see pages 249-250



Standard 6061-T6 aluminum:
Hard Lube-anodized* cylinder tube

XM-19 stainless steel:
Rod; pins

Stands up to sun, salt, and time

- Cylinders come standard with Hard Lube-anodized aluminum or titanium for GP cylinders. Other options available upon request.
- High-strength XM-19 stainless steel rods and pins.
- Durable, low-friction polyurethane seals and bronze-filled PTFE piston seals.
- O-rings in nonabsorbent polyurethane seals for consistent fit.

Variety of cylinder types

- Single-acting; double-pull; locking; boom vang. Single-acting cylinders have air-spring returns, but can be ordered in push, push/pull, and pull/ pull custom versions.
- A variety of standard strokes are available. Custom lengths available upon request

Selection of rod end fittings

- Standard cylinders come with clevis jaw for ends.
- Blocks and different eye types available; see alternate end fittings.
- Smooth anti-sag clevis pins protect rigging and crew.

*For an additional fee, clear-anodized aluminum is available. Clear anodization provides less protection than Hard Lube anodizing.

Stainless Steel and titanium are also available.

Cylinder end fittings are stainless steel only

DO NOT use Harken equipment for human suspension unless product is specifically certified and labeled for such use.

Hydraulic Cylinders

Maximum air return force ratio is 10:1, not included in pull force calculation. Precharge is a maximum of 100 psi (6.9 bar). Custom strokes and end fittings available, see next page 233 for ordering information.

Part No.	Stroke		Pin center length (closed)*		Volume	Weight**		Cap/pin		Bore		Rod		Max OD	@ 1000 psi 69 bar		@ 2000 psi 140 bar		@ 3000 psi 210 bar		@ 4000 psi 275 bar		@ 5000 psi 345 bar					
	-Size	in	mm	in		mm	lb	kg	in	mm	L	in	mm		in	mm	in	mm	lb	kg	lb	kg	lb	kg	lb	kg		
HYCS025110265BCC	-6	10.4	265	18.7	474	2.1	0.97	7	0.11	7/16	11.1	1	25	7/16	11	1.5	38	635	288	1270	576	1905	864	2540	1152	3175	1440	
HYCS025110360BCC	-6	14.2	360	22.4	569	2.5	1.13	9	0.15	7/16	11.1	1	25	7/16	11	1.5	38	635	288	1270	576	1905	864	2540	1152	3175	1440	
HYCS025110530BCC	-6	20.9	530	29.1	739	3.1	1.42	13	0.22	7/16	11.1	1	25	7/16	11	1.5	38	635	288	1270	576	1905	864	2540	1152	3175	1440	
HYCS035130230BCC	-10	9.1	230	19.4	494	3.4	1.54	12	0.19	1/2	12.7	1	38	35	1/2	13	1.94	49	1289	584	2577	1169	3866	1753	5154	2338	6443	2922
HYCS035130350BCC	-10	13.8	350	24	609	4.1	1.88	18	0.29	1/2	12.7	1	38	35	1/2	13	1.94	49	1289	584	2577	1169	3866	1753	5154	2338	6443	2922
HYCS035130510BCC	-10	20.1	510	31.1	789	5.2	2.37	26	0.42	1/2	12.7	1	38	35	1/2	13	1.94	49	1289	584	2577	1169	3866	1753	5154	2338	6443	2922
HYCS040160260BCC	-12	10.2	260	20	508	4.6	2.08	15	0.24	5/8	15.9	1	1/2	40	5/8	16	2.06	52	1460	662	2921	1325	4381	1987	5841	2650	7302	3312
HYCS040160375BCC	-12	14.8	375	24.8	629	5.6	2.53	22	0.35	5/8	15.9	1	1/2	40	5/8	16	2.06	52	1460	662	2921	1325	4381	1987	5841	2650	7302	3312
HYCS040160625BCC	-12	24.6	625	35.6	905	7.8	3.54	36	0.59	5/8	15.9	1	1/2	40	5/8	16	2.06	52	1460	662	2921	1325	4381	1987	5841	2650	7302	3312
HYCS045160260BCC	-17	10.2	260	20	507	5.4	2.47	21	0.35	5/8	15.9	1	3/4	45	5/8	16	2.31	59	2098	952	4197	1904	6295	2856	8394	3807	10492	4759
HYCS045160375BCC	-17	14.8	375	25	634	6.6	3.01	31	0.51	5/8	15.9	1	3/4	45	5/8	16	2.31	59	2098	952	4197	1904	6295	2856	8394	3807	10492	4759
HYCS045160800BCC	-17	31.5	800	43.1	1095	10.9	4.96	66	1.08	5/8	15.9	1	3/4	45	5/8	16	2.31	59	2098	952	4197	1904	6295	2856	8394	3807	10492	4759
HYCS055190275BCC	-22	10.8	275	22.4	568	9.3	4.23	36	0.59	3/4	19.1	2	3/16	55	3/4	19	2.86	73	3316	1504	6633	3009	9949	4513	13266	6017	16582	7522
HYCS055190400BCC	-22	15.7	400	27.3	693	11.2	5.09	52	0.86	3/4	19.1	2	3/16	55	3/4	19	2.86	73	3316	1504	6633	3009	9949	4513	13266	6017	16582	7522
HYCS055190900BCC	-22	35.4	900	49.7	1263	19.5	8.84	118	1.93	3/4	19.1	2	3/16	55	3/4	19	2.86	73	3316	1504	6633	3009	9949	4513	13266	6017	16582	7522
HYCS065220300BCC	-30	11.8	300	25.1	637	12.9	5.83	51	0.83	7/8	22.2	2	1/2	65	7/8	22	3.17	81	4307	1954	8615	3908	12922	5861	17230	7815	21537	9769
HYCS065220405BCC	-30	17.7	450	31	787	15.6	7.06	76	1.25	7/8	22.2	2	1/2	65	7/8	22	3.17	81	4307	1954	8615	3908	12922	5861	17230	7815	21537	9769
HYCS065221025BCC	-30	40.4	1025	55.4	1407	26.5	12.03	174	2.85	7/8	22.2	2	1/2	65	7/8	22	3.17	81	4307	1954	8615	3908	12922	5861	17230	7815	21537	9769
HYCS075250300BCC	-40	11.8	300	27.6	700	20.5	9.29	74	1.22	1	25.4	3	75	1	25	3.8	97	6283	2850	12566	5700	18850	8550	25133	11400	31416	14250	
HYCS075250475BCC	-40	18.7	475	34.4	874	24.9	11.28	118	1.93	1	25.4	3	75	1	25	3.8	97	6283	2850	12566	5700	18850	8550	25133	11400	31416	14250	
HYCS075251150BCC	-40	45.3	1150	63.2	1606	42.8	19.4	284	4.66	1	25.4	3	75	1	25	3.8	97	6283	2850	12566	5700	18850	8550	25133	11400	31416	14250	
HYCS080250300BCC	-48	11.8	300	28.3	719	23.7	10.73	81	1.33	1 1/8	28.6	3	1/8	80	1	25	4.07	103	6885	3123	13769	6246	20654	9368	27538	12491	34423	15614
HYCS080250475BCC	-48	18.7	475	35.1	892	28.8	13.05	129	2.11	1 1/8	28.6	3	1/8	80	1	25	4.07	103	6885	3123	13769	6246	20654	9368	27538	12491	34423	15614
HYCS080251150BCC	-48	45.3	1150	64	1626	49.7	22.56	312	5.11	1 1/8	28.6	3	1/8	80	1	25	4.07	103	6885	3123	13769	6246	20654	9368	27538	12491	34423	15614
HYCS090320375BCC	-60/-76	14.8	375	31.3	796	34.5	15.64	124	2.03	1 1/4	31.8	3	1/2	90	1 1/4	32	4.57	116	8394	3807	16788	7615	25182	11422	33576	15230	41970	19037
HYCS090320505BCC	-60/-76	21.7	550	39.3	999	42.1	19.11	182	2.98	1 1/4	31.8	3	1/2	90	1 1/4	32	4.57	116	8394	3807	16788	7615	25182	11422	33576	15230	41970	19037
HYCS100320425BCC	-90	16.7	425	35	889	51	23.15	190	3.11	1 3/8	34.9	4	100	1 1/4	32	5.34	136	11339	5143	22678	10287	34018	15430	45357	20573	56696	25717	
HYCS100320625BCC	-90	24.6	625	43.3	1099	62	28.14	268	4.39	1 3/8	34.9	4	100	1 1/4	32	5.34	136	11339	5143	22678	10287	34018	15430	45357	20573	56696	25717	
HYCS115350475BCC	-110	18.7	475	39.9	1014	70.2	31.82	270	4.43	1 1/2	38.1	4	1/2	115	1 3/8	35	6	152	14419	6541	28839	13081	43258	19622	57678	26162	72097	32703
HYCS115350700BCC	-110	27.6	700	49.4	1255	85.7	38.86	397	6.51	1 1/2	38.1	4	1/2	115	1 3/8	35	6	152	14419	6541	28839	13081	43258	19622	57678	26162	72097	32703
HYCS130380475BCC	-150	18.7	475	42.9	1090	103.9	47.11	353	5.79	1 3/4	44.5	5	1/8	130	1 1/2	38	6.82	173	18862	8556	37724	17111	56585	25667	75447	34222	94309	42778
HYCS130380700BCC	-150	27.6	700	51.8	1315	121.9	55.3	520	8.52	1 3/4	44.5	5	1/8	130	1 1/2	38	6.82	173	18862	8556	37724	17111	56585	25667	75447	34222	94309	42778

*For pin center length open add stroke length to pin center length closed. **Rod ends (forks) included in weights. ***Max relief setting is 5000 psi/34.5 bar, recommended setting is 4000 psi/27.5 bar.



Adjustable lock prevents rod movement during pressure release.

Locking Cylinders

Harken locking cylinders feature adjustable mechanical locks threaded onto the rod to block rod movement and securely fix its position independently of the boat's pressure system. They are commonly used by large cruisers on extended passages to safely lock the rod during pressure release and as a safety backup for the hydraulic system. A long-stroke cylinder is often used during the mast stepping process to lean the mast forward and hook up the furlers. After commissioning, the cylinder's mechanical lock is engaged, limiting the stroke for sailing.

Part No.*	- Size	Stroke		Pin center length (closed)**		Weight***		Volume		Gap/pin		Bore		Rod		Max OD	
		in	mm	in	mm	lb	kg	in ³	L	in	mm	in	mm	in	mm	in	mm
HYCL045160375BCC	-17	14.8	375	43.9	1116	11.9	5.42	31	0.51	5/8	15.9	1 3/4	45	5/8	16	2.31	59
HYCL055190400BCC	-22	15.7	400	47.6	1210	19.2	8.71	52	0.86	3/4	19.1	2 3/16	55	3/4	19	2.9	73
HYCL065220450BCC	-30	17.7	450	53.6	1362	27.2	12.36	76	1.25	7/8	22.2	2 1/2	65	7/8	22	3.2	81
HYCL075250475BCC	-40	18.7	475	58.5	1487	41.6	18.86	118	1.93	1	25.4	3	75	1	25	3.8	97
HYCL080250475BCC	-48	18.7	475	59.3	1505	49.6	22.52	129	2.11	1 1/8	28.6	3 1/8	80	1	25	4.1	103
HYCL090320550BCC	-60	21.7	550	67	1701	70.1	31.82	182	2.98	1 1/4	31.8	3 1/2	90	1 1/4	32	4.6	116
HYCL100320625BCC	-90	24.6	625	74.4	1889	98.9	44.85	279	4.57	1 3/8	34.9	4	100	1 1/4	32	5.34	136

For pull forces, see cylinder with corresponding bore and rod diameter on page 232.
 *Specify rod and clevis end fittings by adding the appropriate suffix to end of part number. See page 234.
 For pin center length open add stroke length to pin center length closed. *Rod ends (clevis) included in weights.

Ordering Single-Acting & Locking Cylinders

To order use the chart below. Standard cylinders are black hardcoat-anodized with clevises on both ends. Additional cylinder and rod end options of marine eyes, barrel pin eyes, lashing eyes, and blank end fittings are available for a slight upcharge. For optional materials and fittings, replace the last three letters of the part number with your selections.

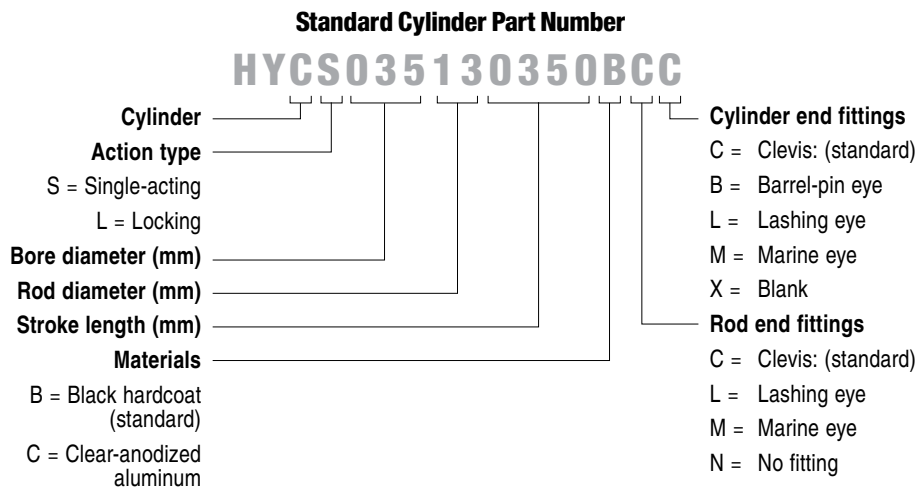

Materials

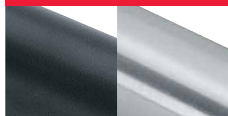

Hardcoat Clear-anodized

Rod End Fittings



Clevis Lashing eye Marine eye No fitting

Cylinder End Fittings



Clevis Lashing eye Marine eye Barrel-pin eye Blank

Double-Pull Cylinders

Double-pull cylinders have rods on both ends and are used with mainsheet travelers or jib sheet car systems to easily adjust loaded sails. As oil is pumped into the cylinder, the rod pulls the traveler while the other rod eases. Reverse the process and the eased rod pulls the other way. Delrin® isolators separate the cylinders from the metal elements of the hull to prevent corrosion.

What makes Harken double-pull cylinders unique is the way they are installed on the boat. To take the cylinder off the mounting brackets for service, the user simply removes four screws, leaving both brackets in place.

Double-pull cylinders do not come with end fittings on the rod because of the variety of cylinder functions. On page 233, you'll find a selection of end fittings to choose from. Fittings are sold separately.



Disassembled endcap with Delrin isolator.

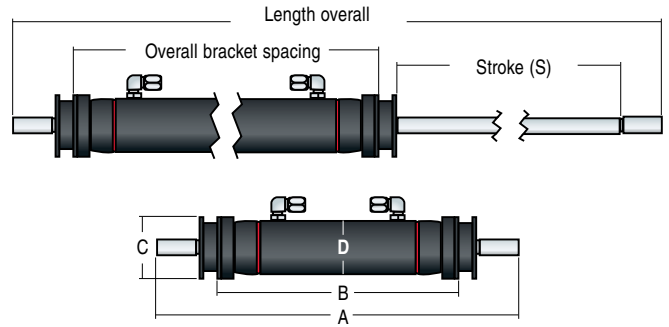

Double-Pull Cylinder Part Number

Cylinders are made to order. Specify desired stroke length in millimeters and optional end fittings when ordering.

HYCP03513xxxxBNN

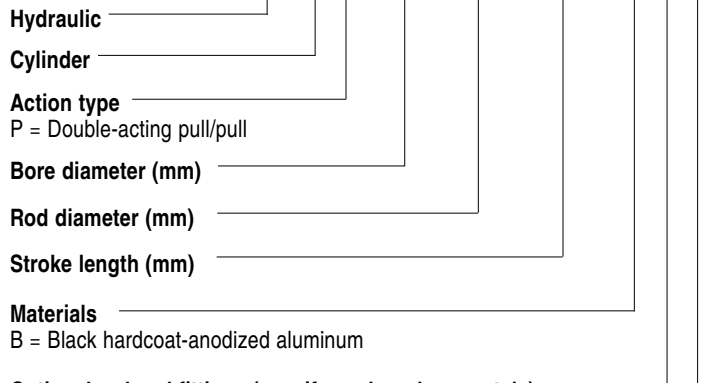

Optional rod end fittings (specify each end separately)

C, L, or N (see page 233 for options); rod end blocks (see page 235)

Delrin is a registered trademark of E. I. du Pont de Nemours and Company or its affiliates.

Part No.	- Size	Zero stroke length (A)*		Zero stroke bracket spacing (B)**		Mounting retainer Ø (C)		Outside Ø (D)		Rod thread size	Rod thread length		Weight	
		in	mm	in	mm	in	mm	in	mm		in	mm	lb @ zero stroke length + lb/in stroke	kg @ zero stroke length + kg/mm stroke
HYCP02511xxxxBNN	-6	11.84	300.8	8.55	217	1.6	41	2	51	7/16-20	1	25	2.07 + .14	0.94 + .002
HYCP03513xxxxBNN	-10	13.86	352	9.27	235.5	1.9	47	2.2	57	1/2-20	1.6	41	3.41 + .25	1.55 + .005
HYCP04016xxxxBNN	-12	13.56	344.5	9.03	229.4	1.9	47	2.2	57	5/8-18	1.6	41	3.87 + .33	1.76 + .006
HYCP04516xxxxBNN	-17	13.85	351.9	9.31	236.4	1.9	47	2.3	58	5/8-18	1.6	41	4.31 + .35	1.96 + .006
HYCP05519xxxxBNN	-22	15.81	401.6	10.22	259.6	2.2	55	2.9	73	3/4-16	2.1	53	7.05 + .51	3.20 + .009
HYCP06522xxxxBNN	-30	17.36	441	11.77	298.8	2.2	55	3.2	81	7/8-14	2.1	53	9.48 + .63	4.30 + .011
HYCP07525xxxxBNN	-40	22.31	566.7	14.16	359.7	3	76	3.8	97	1-12	3.2	82	16.21 + .87	7.36 + .016

*Overall cylinder length equals zero stroke length plus two times the desired stroke.

**Overall bracket spacing equals zero stroke bracket spacing plus the desired stroke.

Cylinder Blocks & Toggles

Rod End Blocks

Cylinders can be set up to use a reverse purchase to move loaded lines controlling functions such as Cunninghams, stay deflectors, travelers, and athwartship jib systems. Harken offers a variety of blocks to help facilitate different reverse purchase arrangements. Blocks are rigid when mounted to the rod. They are available in single, single with becket, and double versions for reverse purchases from 1:2 to 1:4. Custom lashed on V block options are available upon request.

Eye/Jaw Toggles

An eye/jaw toggle provides a cylinder with two axis points of articulation to reduce wire, rod, and end fitting fatigue. Toggles are available in 11 - 44 mm (7/16" - 1 3/4") to match cylinder pin sizes. Eye/jaw toggles are commonly sold with Harken integral backstay cylinders as well as standard cylinders used for standing rigging.

HYDRAULICS Q&A

WHY AREN'T THE SHEAVES ON YOUR CYLINDER ROD END DOUBLE BLOCKS STACKED?

Although slightly longer than blocks with stacked sheaves, our reverse purchase rod end blocks allow the sheaves to align the load directly with the cylinder, preventing premature wear and seal failure.



HYCBS11
HYCBS13
HYCBS16
HYCBS19
HYCBS22

HYCBB16
HYCBB19
HYCBB22

HYCBD11
HYCBD13
HYCBD16
HYCBD19
HYCBD22

ROD END BLOCKS



Cylinder with V block custom configuration



EYE/JAW TOGGLES

Rod End Blocks

Part No.	Description	Fits rod		Weight	Sheave Ø		Length		Reverse purchase
		mm	UNF A		in	mm	in	mm	
HYCBS11	Single	11	7/16-20	0.44	2.0	52	4.0	101	1:2
HYCBD11	Double*	11	7/16-20	0.56	2.0, 1.3	52, 33	5.5	139	1:3, 1:4
HYCBS13	Single	13	1/2-20	0.44	2.0	52	4.0	101	1:2
HYCBD13	Double*	13	1/2-20	0.55	2.0, 1.3	52, 33	5.5	139	1:3, 1:4
HYCBS16	Single	16	5/8-18	0.80	3.2	82	5.2	132	1:2
HYCBB16	Single/becket	16	5/8-18	0.97	3.2	82	7.4	188	1:3
HYCBD16	Double	16	5/8-18	1.02	3.2, 2.0	82, 52	7.5	189	1:4
HYCBS19	Single	19	3/4-16	0.99	3.2	82	5.7	144	1:2
HYCBB19	Single/becket	19	3/4-16	1.24	3.2	82	7.9	200	1:3
HYCBD19	Double	19	3/4-16	1.29	3.2, 2.0	82, 52	7.9	201	1:4
HYCBS22	Single	22	7/8-14	1.69	4.3	108	7.4	189	1:2
HYCBB22	Single/becket	22	7/8-14	2.19	4.3	108	10.8	275	1:3
HYCBD22	Double	22	7/8-14	2.38	4.3, 3.2	108, 82	10.9	278	1:4

Eye/Jaw Toggles

Part No.	Jaw/pin Ø		Length		Fits bore/rod Ø
	in	mm	in	mm	
HYHTEJS11	7/16	11.1	2.0	50.8	25/11
HYHTEJS13	1/2	12.7	2.2	55.9	35/13
HYHTEJS16	5/8	15.9	2.5	63.5	40/16 & 45/16
HYHTEJS19	3/4	19.1	2.9	73.7	55/19
HYHTEJS22	7/8	22.2	3.3	83.8	65/22
HYHTEJS25	1	25.4	3.7	94	75/25
HYHTEJS29	1 1/8	28.6	4.1	104.1	80/25
HYHTEJS32	1 1/4	31.8	4.5	114.3	90/32
HYHTEJS35	1 3/8	34.9	5.6	142.2	100/32
HYHTEJS38	1 1/2	38.1	5.7	144.5	115/35
HYHTEJS44	1 3/4	44.5	7.2	182.6	130/38

*Can be used as becket block.

Maximum working load is equal to maximum pull force for appropriately sized cylinder.

Boom Vangs

Hydraulic vang change the height of the boom to help control sail shape. They also function as a topping lift to hold the boom up when reefing and to keep it level when the sail is flaked. Harken offers a full range of vang cylinders. The HYCV single-acting gas return is the standard vang used for most boats. Double-acting push/pull vangs can be custom ordered.

Megayacht Double-Acting Boom Vangs

For larger yachts with heavier booms, Harken offers more powerful push/pull double-acting vangs. Today's ever-larger, stiffer hull structures and heavier roller-furling booms dramatically increase compression loads on megayacht boom vangs. This can result in cylinder rods buckling. Harken helps prevent this by transferring loads to the outer housing tube, eliminating the load on the rod. Please contact Harken for more information on these designs.

Ordering Boom Vangs

All vangs are made to order. Specify desired PCLC (pin center length closed) in millimeters rounded to the nearest 10mm. Standard vangs are black hardcoat-anodized aluminum with rod clevis and cylinder end clevis.



Boom Vang Cylinder Part Number

HYCV040220255BCCXXX

Action Type

G = Double-acting vang

V = Single-acting vang

Bore Diameter (mm)

Rod Diameter (mm)

Stroke Length (mm)

Materials

B = Black hardcoat-anodized aluminum

C = Clear-anodized aluminum

P = Painted aluminum

Rod End Fittings

C = Clevis

Cylinder End Fittings

C = Clevis

PCLC (mm)

STANDARD BOOM VANGS

Single-acting vang cylinder

MEGAYACHT BOOM VANGS

Double-acting vang cylinder

Boom Vangs

Harken Mega Yacht G vangs come standard with an adjustable clevis that allows for +/- 25mm of adjustment to the PCLC. Options include a mechanical ruler engraved for a quick visual position indication. Harken also offers a laser position indicator installed inside the vang. Carbon painted extension tubes are available on most sizes.

Mega Yacht G Vangs

Part No.*	- Size**	Pull load						Push load***			
		@ 2000 psi 140bar		@ 3000 psi 210 bar		@ 3625 psi 250 bar		@ 4000 psi 275 bar			
		lb	kg	lb	kg	lb	kg	lb	kg		
CXXX	20T	24340	11040	36505	16560	44090	20000	48675	22080	44090	20000
CXXX	25T	30420	13800	45635	20700	55115	25000	60845	27600	55115	25000
CXXX	30T	37035	16800	55550	25200	67240	30500	74240	33875	67240	30500
CXXX	40T	48940	22200	73410	33300	88180	40000	97885	44400	88180	40000
CXXX	50T	61860	28060	92790	42090	112125	50860	128970	58500	112125	50860
CXXX	65T	78925	35800	118385	53700	143100	64910	157410	71400	143100	64910

*part number assigned per order, all custom made

**sizes based on 250bar/3625 psi, max pressure is 275bar/4000 psi

*** Push load is the theoretical load, exact push load based on PCLC

Loading Information

Part No.	- Size	Pull force						Return force						
		@ 1000 psi 69 bar		@ 2000 psi 138 bar		@ 3000 psi 207 bar		@ 5000 psi 345 bar		@ 6000 psi 41 bar**				
		lb	kg	lb	kg	lb	kg	lb	kg	lb	kg			
Single-Acting														
HVCV040220255	BCCXXXX	-12	106	48	1271	577	2437	1105	3603	1634	4769	2163	1060	481
HVCV045250280	BCCXXXX	-17	177	80	1797	815	3416	1550	5036	2284	6656	3019	1443	655
HVCV055250280	BCCXXXX	-22	281	127	3691	1674	6664	3023	9636	4371	12609	5719	2255	1023
HVCV065320330	BCCXXXX	-30	436	197	4418	2004	8099	3674	11781	5344	15463	7014	2945	1336
HVCV075300330	BCCXXXX	-40	600	272	7442	3375	13283	6025	19124	8675	24966	11324	4241	1924
HVCV090380420	BCCXXXX	-60	2081	944	9935	4507	17789	8069	25643	11632	33497	15194	5773	2618
HVCV100480450	BCCXXXX	-90	2265	1028	12071	5475	21876	9923	31681	14370	41486	18818	7540	3420
HVCV115540515	BCCXXXX	-110	2815	1277	15173	6882	27531	12488	39888	18093	52246	23698	9543	4328

*Return force varies based on oil pressure and buckling strength for different PCLCs.

**6000 psi is the standard return gas pressure; maximum allowed is 1000 psi.

XXXX in part number replaced by PCLC in mm rounded to nearest 10 mm.

Part No.	- Size	Stroke in	mm	Pin center length closed (PCLC)		Max in	mm	Weight Base weight lb + (PCLC x lb/in)	Base weight kg + (PCLC x kg/mm)	Volume		Bore in	mm	Diameter Rod		Housing OD in	mm	Extension tube OD in	mm	
				Min in	mm					Retracted in ³	Extended in ³			in	mm					in
Single-Acting																				
HVCV040220255	-12	10.0	254	55	1397	89	2260	2.940 + 0.126	1.33 + 0.00225	12	0.19	15.9	1 1/2	40	7/8	22	1.98	50	1.98	50
HVCV045250280	-17	11.0	279	55	1397	100	2540	4.965 + 0.131	2.25 + 0.00234	18	0.29	15.9	1 3/4	45	1	25	2.27	58	2.19	56
HVCV055250280	-22	11.0	279	55	1397	104	2640	4.026 + 0.244	1.83 + 0.00436	33	0.54	15.9	2 3/16	55	1	25	2.86	73	2.50	64
HVCV065320330	-30	13.0	330	55	1397	107	2720	9.139 + 0.263	4.15 + 0.00470	48	0.78	19.1	2 1/2	65	1 1/4	32	3.17	81	2.86	73
HVCV075300330	-40	13.0	330	55	1397	116	2960	13.076 + 0.300	5.93 + 0.00535	76	1.24	22.2	3	75	1 1/4	32	3.80	97	3.17	81
HVCV090380420	-60	16.5	419	55	1397	152	3860	22.092 + 0.449	10.02 + 0.00802	130	2.12	25.4	3 1/2	90	1 1/2	38	4.57	116	3.86	98
HVCV100480450	-90	17.8	451	65	1651	180	4570	36.369 + 0.666	16.50 + 0.01189	174	2.85	31.8	4	100	1 7/8	48	5.34	136	4.57	116
HVCV115540515	-110	20.3	515	70	1778	182	4620	48.320 + 0.963	21.92 + 0.01720	250	4.1	34.9	4 1/2	115	2 1/8	54	6.00	152	5.34	136



Grand Prix Cylinders

Used for mast, sail, and keel controls, Harken Grand Prix cylinders were specifically designed to withstand the stresses of high-intensity racing. Their longevity and reliability are evident in the selection of high-quality materials and components.

Cylinder housings are machined from aerospace grade titanium. High-strength stainless steel rods provide superior strength and corrosion resistance. 10,000 psi cylinders are available upon request.

Cylinders are offered with clevis jaws and a variety of fittings. Available in push, pull, pull/pull and push/pull styles.

Grand-Prix cylinders are only intended for systems with a vigorous maintenance schedule, as they are built for extremely high loads at a minimal weight.

All Grand Prix cylinders are made to order

To order, specify stroke length in millimeters and rod and cylinder end fitting options. Contact Harken for weights and volumes.



Custom titanium mast ram



Grand Prix cylinder with spherical end cap



TP52 © Max Ranchi



Grand Prix cylinder with V block

Part No.*	Bore Ø		Rod Ø		Pull force**			
	in	mm	in	mm	@ 5000 psi/345 bar		@ 7500 psi/517 bar	
					lb	kg	lb	kg
HYCS01906xxxx	3/4	19	1/4	6	1963	891	2945	1336
HYCS02508xxxx	1	25	5/16	8	3543	1607	5315	2411
HYCS02910xxxx	1 1/8	29	3/8	10	4418	2004	6627	3006
HYCS03210xxxx	1 1/4	32	3/8	10	5584	2533	8376	3799
HYCS03511xxxx	1 3/8	35	7/16	11	6673	3027	10009	4540
HYCS04011xxxx	1 1/2	40	7/16	11	8084	3667	12126	5500
HYCS04513xxxx	1 3/4	45	1/2	13	11045	5010	16567	7515
HYCS04814xxxx	1 7/8	48	9/16	14	12563	5699	18845	8548
HYCS05014xxxx	2	50	9/16	14	14465	6561	21698	9842
HYCS05516xxxx	2 3/16	55	5/8	16	17257	7828	25886	11742
HYCS06018xxxx	2 3/8	60	11/16	18	20295	9205	30442	13808
HYCS06519xxxx	2 1/2	65	3/4	19	22335	10131	33502	15196

Contact Harken to request quote and lead time. *Specify material choice and rod and clevis end fittings by adding appropriate 3-letter code to end of part number. See page 233.

**Maximum air return force ratio is 10:1, not included in pull force calculation. Precharge is a maximum of 100 psi (6.9 bar).



Beau Geste, IRC 52, Cookson Boats,
Botin Partners Naval Architecture © Paul Stubbs

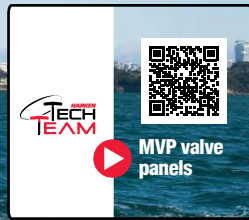

HYDRAULIC VALVES & MANIFOLDS

Harken offers a complete line of lightweight, low-profile valves and manifolds for hydraulic systems. Harken standard valves are half the weight of most styles, with Grand Prix versions sculpted to eliminate more weight. An independent pressure-relief function in each valve allows you to match the hydraulic power to each individual function's working loads. An adjustable flow control integrated into each valve fine-tunes the speed of release.



High-strength, lightweight

- 1 Valves, manifolds, standard valve panels corrosion-resistant, hardcoat-anodized aluminum; stainless fittings for strength.
- 2 Lightweight composite handles textured, contoured for secure grip.

Valves with independent relief, release, and flow match system loads

- Each valve has independent pressure relief for individualized pressure adjustment.
- Each valve has integrated adjustable flow control for fine-tuning release speed.
- Minimum flow rate is 8 L/min (2.1 gpm).
- Pressure relief and release combined into one part saves weight.



Valve handles fit in four directions for easy operation

- Inverted handles on double-sided manifolds have same open/closed positions; rotation direction for easy access.
- Valve stems have tapered shaft to fit handle socket for secure, tight fit.

Options

- Standard valves and manifolds handle up to 5,000 psi; sculpted Grand Prix valves and manifolds handle up to 10,000 psi.
- Valves offered with short and long shafts: short shaft fits 3 mm-thick deck/panel; long shaft 4 mm to 25 mm-thick deck/floor.
- Double-acting valves for traveler controls, other functions using twin or double-acting cylinders.
- Inline relief valves: control maximum system pressure; inline relief valves work with any manual system, manifold-mount reliefs fit Harken manifolds.
- Remote dump valves: ease sail controls from helm, rail, other positions on boat; use as quick release or regulate speed with optional adjustable flow control.
- Single- and double-sided manifolds accommodate up to nine valves for multiple functions.

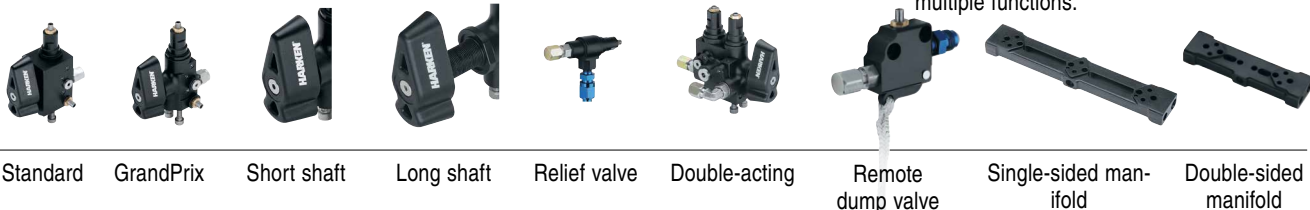

DO NOT use Harken equipment for human suspension unless product is specifically certified and labeled for such use.

Valve and Pump Panels

Harken offers a variety of valve and pump panel options. Standard panels come mounted on black hard-coated alloy face plates. Common configurations are in the chart below. Custom configurations with different face plates, no face plates, no gauges, and lightweight Grand Prix valve options are also available.

Part No.	Description	Panel length		Panel height		Weight		
		in	mm	in	mm	lb	kg	
Valve only panels								
HYA1000XPGBXJ	Hydr manifold valve kit-1 valve panel w/gauges	6.00	152.40	8.00	203.20	1.42	0.65	
HYA2000XPGBXJ	Hydr manifold valve kit-2 valve panel w/gauges	9.25	234.95	8.00	203.20	2.97	1.35	
HYA3000XPGBXJ	Hydr manifold valve kit-3 valve panel w/gauges	12.50	317.50	8.00	203.20	4.53	2.05	
HYA4000XPGBXJ	Hydr manifold valve kit-4 valve panel w/gauges	15.72	399.29	8.00	203.20	6.20	2.81	
Pump only panels								
HYAPM1BJ	Hydr pump kit 1 speed	8.00	203.20	9.00	228.60	3.62	1.64	
HYAPM2BJ	Hydr pump kit 2 speed	8.00	203.20	9.00	228.60	4.72	2.14	
Pump & valve panels								
HYA1000XPGB2JL	Hydr panel kit-1 valves w/gauges & 2spd pump left	11.75	298.45	9.00	228.60	5.73	2.60	
HYA2000XPGB2JL	Hydr panel kit-2 valves w/gauges & 2spd pump left	15.00	381.00	9.00	228.60	7.27	3.30	
HYA3000XPGB2JL	Hydr panel kit-3 valves w/gauges & 2spd pump left	18.25	463.55	9.00	228.60	8.83	4.01	
HYA4000XPGB2JL	Hydr panel kit-4 valves w/gauges & 2spd pump left	21.50	546.10	9.00	228.60	10.51	4.77	
Dump valves								
HYVDPBF	Valve assy-push button dump valve w/flow	N/A	N/A	N/A	N/A	0.30	0.15	
HYVDSPF	String pull dump valve w/flow	N/A	N/A	N/A	N/A	0.20	0.08	



HYA2000RGXXXJ



HYA2000RPGBXJ



HYVDSPF

Ordering Valve Assemblies

Use this guide to configure your valve assembly order. Standard valve assemblies come with the "J" port fitting option and Grand Prix assemblies come with "X" port fitting. For other fitting options, replace the last letter of the part number with your selection.

Valve Assembly Part Number

HYA2000RGXXXJ

Valves on manifold:
 Number of single-acting valves on top = 2
 Number of double-acting valves on top = 0
 Number of single-acting valves on bottom = 0
 Number of double-acting valves on bottom = 0

Relief:
 X = No relief
 R = Manifold relief
 I = In-line relief

Valve/manifold type:

G = Grand Prix/sculpted
 P = Standard

Number of gauges:

X = No gauges
 G = One gauge for each valve

Panel type:

X = No panel, short shaft
 T = No panel, long shaft
 B = Black hardcoat-anodized aluminum panel
 C = Clear-anodized aluminum panel
 F = Carbon fiber panel
 S = 316 stainless steel panel

Pump:

X = No pump
 1 = 1-speed pump
 2 = 2-speed pump

Port fittings:

J = Stainless steel -4 JIC pressure port and -6 brass hose barb supply/return port
 X = Plugs on all ports*

*Other fittings available. Contact Harken.

MVP-1 Single Control & MVP-4 Multi Control Panels



Valve Panels



Harken single and multifunction valve panels are used by larger cruisers to control systems like backstays, boom vang, and outhauls. Available as kits, single-function panels are offered with 2-liter reservoirs and multifunction panels with 4-liter reservoirs. Both panels come with pumps, handles, gauge, pressure relief, and release functions. Panels come standard with a 1- or 2-speed pump.

The single-function valve is a simple on/off system that can operate the cylinder remotely, allowing the user to tension the backstay cylinder from the cockpit. Multifunction panels can operate up to four cylinders remotely, with a selector handle choosing 1 of 4 functions. Valve panels feature an easy-to-read gauge and a finger-controlled knob for pressure release.

Single and multifunction panels come standard in black hardcoat-anodized 6061-T6 aluminum. Panels also offered in clear-anodized aluminum, stainless steel, or carbon fiber.



Kit includes multi- or single-function control panel, pump handle, reservoir, low-pressure hose, and suction filter.



Back of valve panel



Hardcoat-anodized aluminum



Clear-anodized aluminum



Carbon fiber



Stainless steel



MVP-1 SINGLE CONTROL PANEL



MVP-4 MULTI CONTROL PANEL

Part No.	Description	Length		Width		Depth		Weight		
		in	mm	in	mm	in	mm	lb	kg	
MVP-4 Multi Control										
HYAMXPGB2J	4-function panel/hardcoat-anodized aluminum/2-speed	9 1/4	235	11 1/2	292	5 3/4	146	8.5	3.85	
HYAMXPGC2J	4-function panel/clear-anodized aluminum/2-speed	9 1/4	235	11 1/2	292	5 3/4	146	8.5	3.85	
HYAMXPGS2J	4-function panel/stainless steel/2-speed	9 1/4	235	11 1/2	292	5 3/4	146	11.9	5.4	
HYAMXPGF2J	4-function panel/carbon fiber/2-speed	9 1/4	235	11 1/2	292	5 3/4	146	7.8	3.53	
HYAMXPGB1J	4-function panel/hardcoat-anodized aluminum/1-speed	9 1/4	235	11 1/2	292	5 3/4	146	7.4	3.34	
HYAMXPGC1J	4-function panel/clear-anodized aluminum/1-speed	9 1/4	235	11 1/2	292	5 3/4	146	7.4	3.34	
HYAMXPGS1J	4-function panel/stainless steel/1-speed	9 1/4	235	11 1/2	292	5 3/4	146	10.7	4.86	
HYAMXPGF1J	4-function panel/carbon fiber/1-speed	9 1/4	235	11 1/2	292	5 3/4	146	6.6	2.99	
MVP-1 Single Control										
HYASXPGB2J	Single-function panel/hardcoat-anodized aluminum/2-speed	9 1/4	235	11 1/2	292	5 3/4	146	6.9	3.13	
HYASXPGC2J	Single-function panel/clear-anodized aluminum/2-speed	9 1/4	235	11 1/2	292	5 3/4	146	6.9	3.13	
HYASXPGS2J	Single-function panel/stainless steel/2-speed	9 1/4	235	11 1/2	292	5 3/4	146	10.3	4.68	
HYASXPGF2J	Single-function panel/carbon fiber/2-speed	9 1/4	235	11 1/2	292	5 3/4	146	6.2	2.81	
HYASXPGB1J	Single-function panel/hardcoat-anodized aluminum/1-speed	9 1/4	235	11 1/2	292	5 3/4	146	5.7	2.59	
HYASXPGC1J	Single-function panel/clear-anodized aluminum/1-speed	9 1/4	235	11 1/2	292	5 3/4	146	5.7	2.59	
HYASXPGS1J	Single-function panel/stainless steel/1-speed	9 1/4	235	11 1/2	292	5 3/4	146	9.1	4.14	
HYASXPGF1J	Single-function panel/carbon fiber/1-speed	9 1/4	235	11 1/2	292	5 3/4	146	5	2.27	

Compact Control Panel

Harken's Compact Control Panel provides sailors with a single-speed, single-function panel pump for remote cylinder operation. This no-frills model is clean and uncomplicated, with the same quality you expect from a Harken hydraulic product. The double-acting pump delivers oil when the pump handle is pushed and pulled, moving oil efficiently through the system. The panel's pressure-release knob cannot be over-tightened by hand and cause damage to the valve. Pressure relief is factory-set at a maximum 5000 psi to prevent crew from over-tensioning the system. The panel's small footprint takes up very little space, providing a variety of mounting options. The wide bolt pattern on the pump minimizes stress and stabilizes the pump.

The kit comes with pump, valve manifold, 2-liter tank, handle, filter, and hose.

Available in black hardcoat-anodized 6061-T6 aluminum.



Back of valve panel



Compact Control Panel

Part No.	Description	Length		Width		Depth		Weight	
		in	mm	in	mm	in	mm	lb	kg
HYACXPXB1J	Compact single-function panel/hardcoat-anodized/1-speed	9	229	6 1/2	165	2 9/16	65	5	2.27

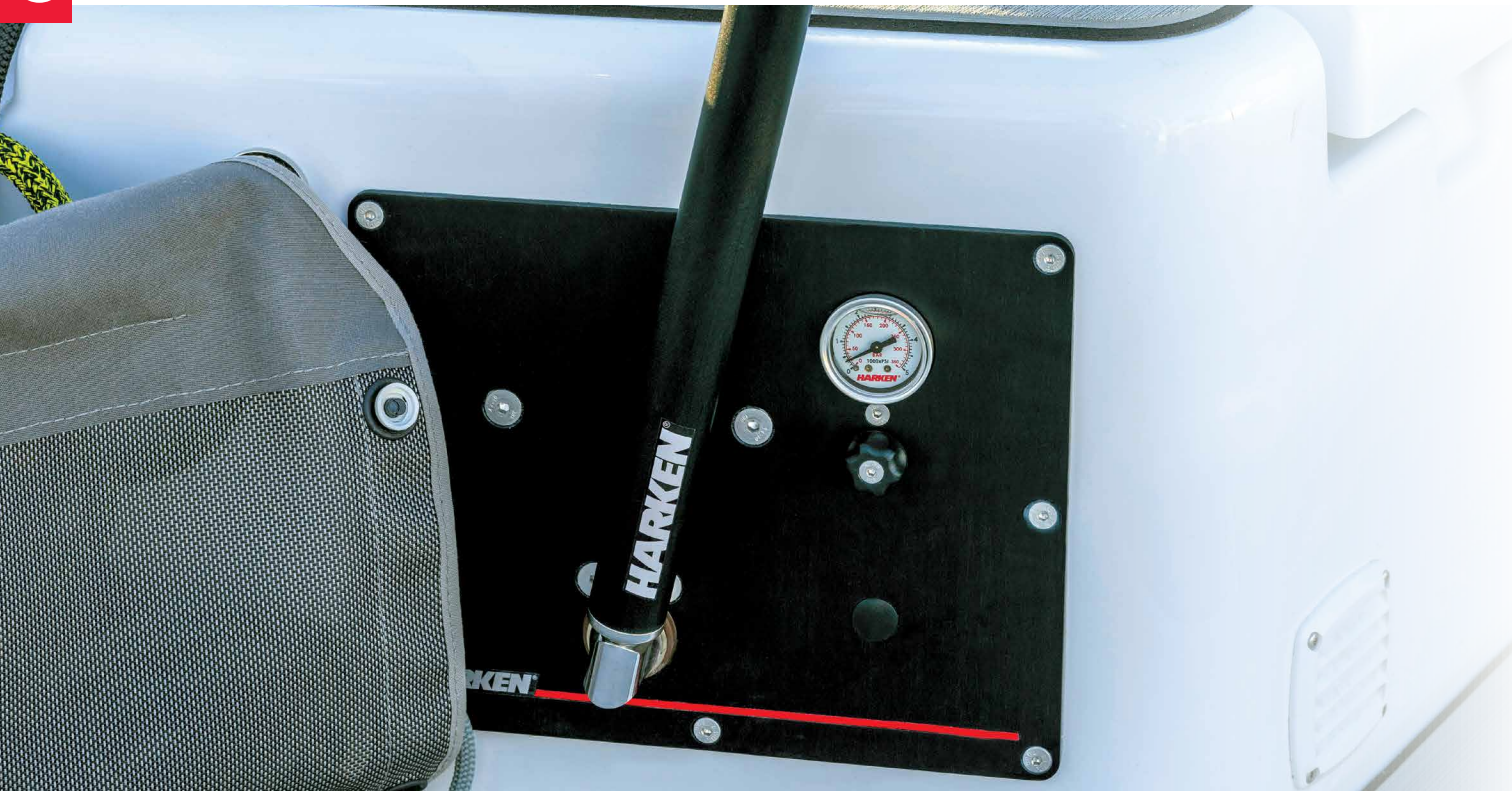

Hydraulic Pumps

Harken offers 1- and 2-speed pumps for hydraulic systems. Our 2-speed pump automatically shifts to the next speed when a preset point is reached. The 1-speed pump is a simpler alternative but features the same high-quality components. 1-speed pumps are used for smaller and midsize hydraulic systems, usually on MVP or compact panels. 2-speed pumps are used on systems with higher oil volume cylinders and need faster reaction time. They are also available on MVP panels. Pressure relief on 1- and 2-speed pumps is factory-set to a maximum of 5000 psi. Mounting patterns for all pumps are identical, making upgrades easy.

An optional adhered isolation plate further improves load distribution by transferring torque directly to the mounting surface rather than the bolt holes when mounting without a face plate. Pumps have 7-degree splined shafts to ensure a tight fit and to allow the handle to be mounted at the sailor's preferred pumping angle.

Hydraulic Rotary Pumps

Harken offers two sizes of multi-speed, pedestal-driven rotary pumps for Grand Prix race boats. Pumps are made of corrosion-resistant hard lube-anodized aluminum, with aluminum, titanium, and stainless-steel components. Both pumps are bi-directional and have the same displacement if rotated in either direction. All pumps include a non-return valve on the outlet to prevent backflow.

10 cc Pumps

A female spline attaches these pumps directly to any Harken pedestal. Six double-stepped pistons save weight and feature connecting rods for piston return rather than springs. Three fasteners provide quick connect/disconnect mounting. The 10 cc pump shifts from 1st to 2nd gear both automatically and manually, with automatic shift points determined by the maximum output of the grinders. If fewer crew are grinding and not enough power is generated to reach the automatic shift point, pumps can be shifted manually.

Adjustable Cam Multiple Displacement Pump

Developed for the America's Cup foiling monohulls, these pumps allow adjustment of flow rates per available grinder input versus pre-set flow/pressure levels. The pump has two banks that may be adjusted by changing piston size with inserts along with different cam positions to allow for flow from 4.75 cc to 16.3 cc per revolution for each bank. Harken will help you determine which setup is best. If requirements change, Harken can upgrade the pump to a different set of pistons insert and cam position to meet them. The pump also has an option of a built-in shift block (manual or electric) making it a 2- or 3-speed pump. A remote shift option (manual or electric) is also available. Please contact Harken for more information.



Optional isolation plates made of extremely resilient G10 improve load distribution by transferring torque directly to the mounting surface.



1-SPEED PUMP



2-SPEED PUMP



10 CC ROTARY PUMPS



Part No.	Description	Output/stroke (push and pull)						Max pressure		Ports/fittings		Weight	
		1st		2nd		3rd		psi	bar	Suction	Pressure	lb	kg
		in ³	cc	in ³	cc	in ³	cc						
HYPM1	1-speed pump with pressure relief	0.25	4.1					5000	345	3/8" hose barb	1/4" 37° JIC	3.2	1.44
HYPM2	2-speed pump/auto shift with pressure relief	0.99	16.3	0.25	4.1			5000	345	3/8" hose barb	1/4" 37° JIC	4.3	1.95
HYPM3MP	Pump anti-torque mounting plate											0.1	0.07

Part No.	Description	Output/Revolution				Max RPM	Max Pressure		input spline	Ports/Fittings		Weight	
		1st in	1st cc	2nd in	2nd cc		psi	bar		suction	Pressure	lb.	kg
HYPR262	10 cc two-speed pump	0.63	10.4	0.26	4.3	400	7500	517	25mm female spline	-6 JIC	-4 jic	6.3	2.85
HYPR314	Adjustable displacement pump	between 4.75 cc / .290 cubic inch 16.3 cc / .994 cubic inch per revolution for each bank.				400	7500	517	24 mm hex	-12 SAE	one or two -6 SAE	13.73*	6.23*

*Weight of pump with 3/8 and 9/16 piston inserts

Hydraulic Reservoirs

Harken offers pressurized carbon fiber/composite reservoirs and vented blow-molded reservoirs for manual hydraulic systems.

Pressurized Reservoirs

All Harken pressurized reservoirs have translucent sections in the reservoir walls, making it easy to monitor oil levels. Pressurized reservoirs require very little maintenance and are cleaner than those that use ambient air pressure. They can be installed in the bilge rather than at pump level to provide a low center of gravity.

Grand-Prix Pressurized Reservoirs

Harken offers Grand-Prix pressurized reservoirs to suit any Grand Prix need. They are among the lightest in existence.

Reservoirs can be built with up to three ports on each end, customizable to whatever application is required. One-way return-line check valves, supply-line shutoff valves, and high-quality regulators are available to meet specific needs. Custom sizes and configurations are available. Contact Harken.

Vented Reservoirs

Harken offers 2- and 4-liter blow-molded reservoirs for standard installations. Reservoirs feature a vented cap to stabilize tank pressure and prevent leaks. Translucent materials allow oil levels to be easily monitored. 10 mm (3/8") hose barbs come standard for supply and return hoses.

Pump Handles

Standard round-tipped handles are made of knurled 6061-T6 hardcoat-anodized aluminum and fit standard HYPM1 and HYMP2 pumps. Grand Prix versions are available in carbon fiber. An optional square-tipped style allows the handle to be rocked 5 degrees laterally from the pumping direction to store against the cockpit wall.



CARBON FIBER HANDLE

ALUMINUM HANDLE



GRAND-PRIX PRESSURIZED RESERVOIRS



VENTED RESERVOIRS



PRESSURIZED RESERVOIRS

Part No.	Description	Maximum capacity		Oil capacity		Height		Maximum dimensions		Depth		Weight	
		gal	L	gal	L	in	mm	in	mm	in	mm	lb	kg
HYRPC02	Pressurized composite reservoir	0.5	2	0.32	1.2	12.2	310	6.3	160	5.8	148	2.1	0.97
HYRPC04	Pressurized composite reservoir	1.1	4	0.63	2.4	17.9	455	6.3	160	5.8	148	2.8	1.28
HYRPC08	Pressurized composite reservoir	2.1	8	1.2	4.7	31.2	793	6.3	160	5.8	148	4.3	1.96
HYRPC10	Pressurized composite reservoir	2.6	10	1.6	5.9	37.2	946	6.3	160	5.8	148	5.2	2.34
HYRVP02	Vented blow-molded reservoir	0.5	2	0.4	1.5	7.1	181	8.7	220	4.1	105	0.8	0.36
HYRVP04	Vented blow-molded reservoir	1.1	4	0.8	3	11.7	298	8.7	220	4.1	105	1.2	0.55

Additional sizes available. Contact Harken.

Pump Handles

Part No.	Description	Ø		Length		Weight	
		in	mm	in	mm	lb	kg
HYPMH6600	Pump handle 600 mm/aluminum	1 1/4	32	23 5/8	600	1.2	0.56
HYPMH6800	Pump handle 800 mm/aluminum	1 1/4	32	31 1/2	800	1.5	0.7
HYPMHC800	Pump handle 800 mm/carbon fiber	1 1/4	32	31 1/2	800	1.0	0.45
HYPMHC800S	Pump handle 800 mm/carbon fiber/square tip	1 1/4	32	31 1/2	800	1.0	0.45
HYPMHC1000	Pump handle 1000 mm/carbon fiber	1 1/4	32	39 3/8	1000	1.2	0.53
HYPMHC1000S	Pump handle 1000 mm/carbon fiber/square tip	1 1/4	32	39 3/8	1000	1.2	0.53

Hydraulic Accessories

Harken offers a complete range of high-quality kits and components for the professional installation, service, and maintenance of your hydraulic system.

Filters

Filtration is essential to the health and longevity of your hydraulic system. Harken recommends the 40-micron suction/return filter between the reservoir and the pump as well as an extremely fine 3-micron filter between the pump and the valves. The 40-micron filter has an anodized aluminum body with a removable, cleanable, and replaceable sintered bronze element. The high pressure 3-micron filter is made from electropolished 17-4 PH stainless steel or titanium. It has a replaceable paper element and can handle pressure up to 10,000 psi. -4SAE ports allow the high-pressure filter to accept any combination of fittings and adapters.

Pressure Transducers

Pressure transducers use the onboard computer to convert hydraulic pressures of up to 10,000 psi into tons or other load units. Standard lightweight versions and super lightweight Grand Prix versions are available. Contact Harken for availability and options.

Pressure Gauges

Pressure gauges, offered as an alternative to electronic transducers, can be mounted into the valve panel or plumbed remotely into a pressure line. Stainless steel 40 mm (1 1/2") cases are filled with glycerin to dampen needle movement.

Plumbing

Harken has a complete line of high-pressure and low-pressure plumbing for manual hydraulic systems. All high-pressure fittings and adapters are machined from stainless steel. Hoses can be sent to you assembled and preflushed.

Seal Kits

Seal kits are available for all valves, cylinders, and pumps. Kits include all normal wear items such as O-rings, seals, and nylon tip set screws.

Repair Kits

Repair kits are available for all valves, cylinders, and pumps. They include everything in the seal kit with the addition of select machined components that may require occasional replacement.

HAWE Tool

The HAWE tool is used for removing and reinstalling the check valves included in valve and pump repair kits.

Hydraulic Oil

Our hydraulic oil was chosen specifically for Harken high-pressure hydraulic systems. Its moisture-resistant formula features unique anti-wear additives that inhibit corrosion and provide high levels of thermal and oxidation stability to enhance lubricant performance and extend equipment life.

HYOIL22QUART: one-quart bottle.

Filters

Part No.	Description	Max pressure		End fittings		Weight	
		psi	bar	Port 1	Port 2	lb	g
HYFAP03S	High-pressure filter/stainless steel/3 micron	10000	689	-4 ORB female	-4 ORB female	.63	288
HYFAP03TF	High-pressure filter/titanium/3 micron	10000	689	-4 ORB female	-4 ORB female	.37	167
HYFAP03TM	High-pressure filter/titanium/3 micron	10000	689	-4 ORB female	-4 JIC/ORB male	.38	172
HYFAT40	Low-pressure filter/40 micron	250	17	3/8" (-6) barb	3/8" (-6) barb	.10	45
HYFAT40J6	Low-pressure filter/high-flow/40 micron	250	17	-6 JIC male	-6 JIC male	.17	75



Filters



Pressure transducer



Pressure gauge



Plumbing



Seal kit



Repair kit



HAWE tool

HYOIL22QUART



Go to www.harken.com/hydraulicaccessories for more detailed information.

Hydraulic Hose

Harken offers a range of hydraulic hoses for high- and low-pressure oil delivery. After assembly, all high-pressure hoses are flushed clean of contaminants before shipping. See standard range of hose and end fittings below. Contact Harken for any custom needs you may have.

High-Pressure Hose

The HYZHP520N-3, -4, and -6 are general purpose pressure hoses used for oil delivery to cylinders and other motor functions. They feature durable nylon tubing reinforced with high-strength aramid fiber and an abrasion-resistant polyurethane cover. Fittings sold separately.

Low-Pressure Hose

The HYZHT7212-6 is a tank line hose. The light, flexible hose is made of Nitrile rubber with braided neoprene reinforcement. Hose-barb fittings allow an easy-push connection.

High-pressure hose end fittings

Harken offers high pressure hose fittings in cadmium-plated steel or, for greater durability, stainless steel. See chart below for standard fittings. Harken stocks many other configurations of hose ends.

For complete assemblies including hoses, contact Harken.



Hoses

Part No.	Description	- Size	Working pressure*		Minimum bend radius		Weight	
			psi	bar	in	mm	lb/ft	kg/m
HYZHP520N-3	3/16" High-pressure hose	-3	5000	345	1.5	38	0.05	0.07
HYZHP520N-4	1/4" High-pressure hose	-4	5000	345	2	51	0.07	0.1
HYZHP520N-6	3/8" High-pressure hose	-6	4000	276	2.5	64	0.08	0.13
HYZHT7212-6	3/8" Low-pressure hose	-6	300	21	3	76	0.12	0.18

*Typical burst pressure is 4:1.

Nomex is a registered trademark of E. I. du Pont de Nemours and Company or its affiliates.
Kevlar is a registered trademark of E. I. du Pont de Nemours and Company or its affiliates.

High-Pressure Hose End Fittings

Part No.	Material	Description	Fits hose	End fitting
HYZSSJF4H3	HYDR FIT-SWV SS-4JICF TO -3HOSE PARKER 10655	Stainless steel	HYZHP520N-3	female -4 (1/4") JIC
HYZSSJF4H4	HYDR FIT-SWV SS-4JICF TO -4HOSE PARKER 10655	Stainless steel	HYZHP520N-4	female -4 (1/4") JIC
HYZSSJF6H6	HYDR FIT-SWV SS-6JICF TO -6HOSE PARKER 10655	Stainless steel	HYZHP520N-6	female -6 (3/8") JIC
HYZSCJF4H3	HYDR FIT-SWV STL-4JICF TO -3HOSE PARKER 10655	Steel/Cadmium plate	HYZHP520N-3	female -4 (1/4") JIC
HYZSCJF4H4	HYDR FIT-SWV STL-4JICF TO -4HOSE PARKER 10655	Steel/Cadmium plate	HYZHP520N-4	female -4 (1/4") JIC
HYZSCJF6H6	HYDR FIT-SWV STL-6JICF TO -6HOSE PARKER 10655	Steel/Cadmium plate	HYZHP520N-6	female -6 (3/8") JIC

Through-Deck Gland

The Harken Through-Deck Gland provides a waterproof passage for hydraulic hose. Unlike other glands, Harken's model can be easily installed by one person topside. The gland's doughnut-shaped base secures over a predrilled hole in the deck with high-strength bonding tape. The urethane seal and top cap is put on the hose before attaching the swage fitting. The swage fitting passes through the deck/base, and the top cap is threaded to the base for a watertight fit.

The through-Deck Gland comes in black hard coat-anodized 6061-T6 aluminum. It fits HYZHP520N 5 mm (3/16"), 6 mm (1/4"), and 10 mm (3/8") hose sizes.

For complete assemblies including hose contact Harken.

Part No.	Description	Gland Max Ø		Hose Ø		Height		Weight	
		in	mm	in	mm	in	mm	lb	kg
HYZD6-3	Through-Deck Gland	2.3	60	3/16	5	1	26	.2	0.11
HYZD6-4	Through-Deck Gland	2.3	60	1/4	6	1	26	.2	0.11
HYZD6-6	Through-Deck Gland	2.3	60	3/8	10	1	26	.2	0.11

Go to www.harken.com/hydraulicaccessories for more detailed information.

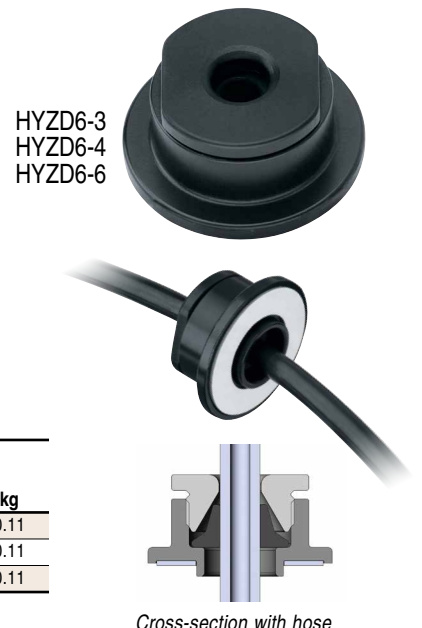

Cross-section with hose

Choosing Hydraulic Systems

1. Cylinders

Load and Pin Sizes: Cylinder size is determined by cylinder load and pin size. Stroke length is based on cylinder function. See page 232 to select cylinder. Double-pull, locking, and boom vang cylinders are also available. See charts for loads, pin sizes, and stroke lengths.

Alternate End Fittings: Choosing the correct end fittings for your cylinders is critical. See page 233 for end-fitting options.

2. Control Valves

Select valves based on sailing style and valve style, type, and functions. Choose between multifunction panel and individual valves, standard or Grand Prix styles. Single- or double-acting valves are based on cylinder type.

Individual Valve Assemblies: Individual valve assemblies are dependent on how the boat is sailed. Determine if there are multiple or single control locations. Choose valve, manifold configurations, and panel types. See page 240.

Multifunction Valve Panels and Single-function Panels: Choose plate materials. Single and multifunction panels come with a 2-speed pump, pump handle, and reservoir. See page 241.

Remote Dump Valves: Determine if there are remote dump valves required. Example: vang cylinders.

3. Pumps and Handles

Individual valves require a separate pump. How many? Choice depends on oil volume, how fast oil must move, and pressure required. Select adequate handle. See pages 243-244.

4. Reservoirs

Reservoir Type: Reservoir type is determined by the amount of oil needed and pump height relative to the reservoir. Use a pressurized reservoir if it is mounted more than 1.5 m (5') vertically below the pump. Vented reservoirs are adequate under 1.5 m (5').

Reservoir Size: As a general rule, select reservoir size by adding up cylinder volumes and multiplying by 2.

5. Accessories

Filters: Harken highly recommends a high-pressure filter between the pump and valves to keep valves working at peak performance. Also required is a suction filter for the pump to prevent debris from entering the system.

Gauges: Remote analog gauges and digital transducers are available.

Fittings: Plumbing fittings, additional spares, and spare parts available. See page 245-246.

Hose: Harken offers hoses and fittings for both high- and low-pressure plumbing needs. Harken can also provide complete hose assemblies to your specification. All high-pressure hose assemblies are flushed before shipping. See page 246.

Standard System

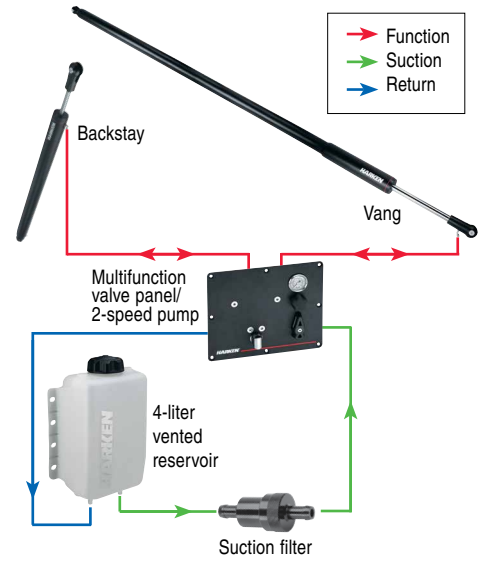

Grand Prix System

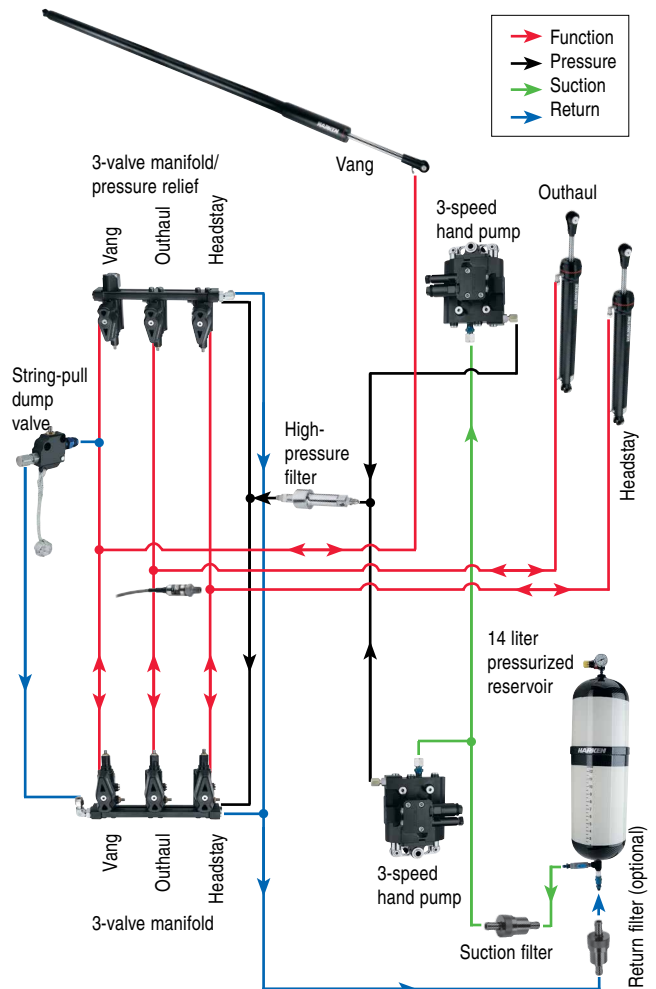



DC HYDRAULIC POWER SYSTEMS

When designing a powered system, we first gather information on the number of functions as well as flow and pressure requirements for each. Every powered system is different. Harken is committed to providing systems designed specifically to account for flow, pressure, and other performance requirements of each project. We also talk to the customer about how the boat will be used to assure the system will perform as expected.

Harken DC hydraulic systems power functions including cylinders, vang, lifting keels, winches, furlers, windlasses, and small bow thrusters. The system is comprised of three main components:

High-flow, low-pressure power units are ideal for powering winches, furlers, small windlasses, and thrusters.

- **The power unit** includes motors and pumps to deliver oil. We offer a variety of options for different flow and pressure needs. All power units include return filtration, motor temperature sensors, and tank level sensors.
- **Valves** direct and deliver oil to hydraulic functions. Our family of modular cartridge manifold valves stack together for an extremely flexible system. These zero-leak valves have flow and pressure controls as well as pressure relief.
- **The electrical control box** is the brain of the system. On-deck push button controls turn valves and pumps on/off. Our latest control boxes all include a small PLC controller to map inputs to outputs. Boxes come pre-wired. Simply plug M12 cables to connectors on the outside of the box.

We provide hands-on service for all Harken hydraulic power systems and we look forward to serving our customers beyond their expectations. Please contact us with any of your hydraulic powered system needs. We will be happy to provide detailed specifications and a quote.

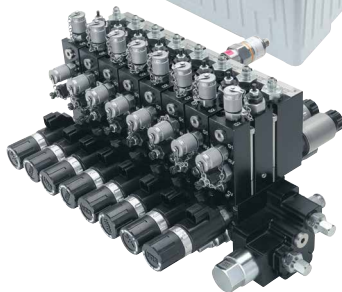
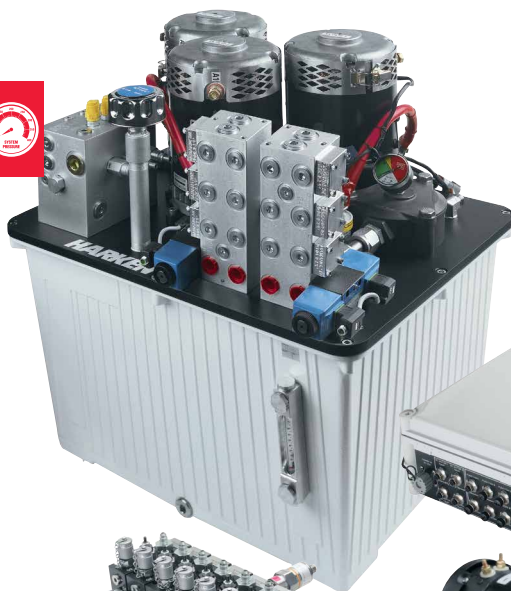

Modular cartridge manifold valves.



High-pressure, low-flow compact power units are perfect for powering cylinder functions.

DO NOT use Harken equipment for human suspension unless product is specifically certified and labeled for such use.

Harken Materials & Properties

Aluminum

6061-T6: an aluminum alloy that has excellent corrosion resistance to air and salt water. It is an easily welded, tough alloy that responds well to anodizing.

7075-T6: the strongest aluminum alloy with strength comparable to many steels. Harken uses 7075-T6 in its Grand Prix cylinders which are built to handle extremely high loads at minimal weight. A vigorous maintenance schedule is required when using this alloy, because corrosion resistance is lower than 6061-T6. Available in hardcoat or clear-anodized finishes.

Bearings

Bearing properties are functions of contact area, material type, bearing cages, and whether the bearing rolls or slides.

Types

Ball bearings: very low-friction; low/medium-load capacity.

Roller bearings: low-friction; high-load capacity.

Sleeve bearings: medium/high-friction; extremely high-load capacity.

Materials

Stainless steel is stronger than Torlon® thermoplastic and Torlon is stronger than Delrin® acetal resin. Because stainless is heavier and usually higher maintenance, Torlon is used in most high-load applications.

Contact Area

More contact between the bearing and the race increases friction, but also increases load capacity. Balls are loaded on small points, cylindrical rollers are loaded along their length, and sleeve bearings are curved around the shaft so a large portion is in contact. Unlike balls and cylinders, sleeves are not prone to being flattened by extreme or static loads because they already conform to the curvature of the shaft.

Motion (rolling, caged rolling, or sliding)

Sliding bearings (known as sleeve, plain, full-contact, bushing, or journal bearings) are very high strength, but have nothing to reduce friction between contact areas. At most, they have a low-friction sleeve between the surfaces. Rollers and balls avoid almost all of this friction because they do not slide against the race, though they can come in contact with each other. Caged roller bearings are separated from each other to avoid this.

Caged Bearings

Caged bearings are roller bearings held in a cage that keeps them separated from each other and parallel to reduce friction. Caged bearings are used in winches and Black Magic blocks.

Captive Bearings

Captive bearings are ball bearings that are contained so they won't spill during product maintenance. Black Magic blocks have ball bearings held captive by the lip of the sheave. CB traveler cars feature ball bearings held captive by a wire guide.

Carbo

Carbo Air blocks feature lightweight, fiber-reinforced, nylon-resin sideplates with a 60% higher MWL than stainless-reinforced Classic blocks. Lightweight fiber-reinforced Carbo-Cams are ideal for racing where weight is critical. The Carbo name comes from an additive that gives blocks their color and UV-resistance.

Carbon Black

Carbon black is a color additive used in black Delrin ball bearings, block sheaves, and sideplates to protect against UV exposure.

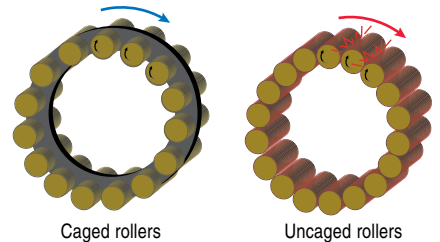
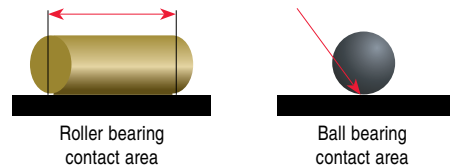
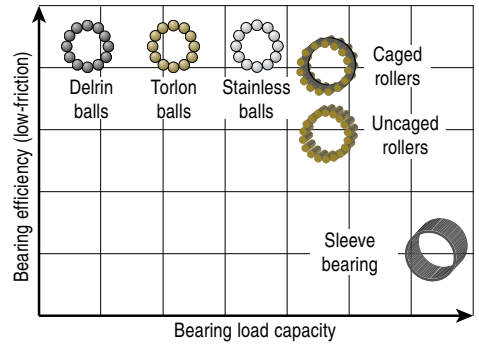

For complete listing, see www.harken.com/glossary

Delrin is a registered trademark of E. I. du Pont de Nemours and Company or its affiliates.
Torlon is a registered trademark of Solvay Advanced Polymers, L.L.C.

Harken Materials & Properties

Clear-Anodized

Clear aluminum anodizing is an electrochemical process that produces a corrosion-resistant finish. It also hardens the surface, making components less prone to scratches and dents. It is “clear” because the protective layer isn’t thick enough to change the color of the component (though dye can be added). More rigorous anodizing, such as hardcoat, can give components a black or colored hue.

Delrin® Acetal Resin

Black (white in older blocks) material which excels in small boat and low to moderate-load applications. Delrin® acetal resin is used for bearings, sheaves, and sideplates.

Hardcoat-Anodized

Hardcoat aluminum anodizing is an electrochemical process that produces a corrosion-resistant finish with hardness characteristics second only to diamonds. Harken's hardcoating process is twice as thick as black anodizing to provide extra protection against scratches, dents, superficial deformation, and corrosion.

Hard Lube-Anodized

Hard Lube-anodized aluminum includes all the corrosion-resistant properties of hardcoat-anodized aluminum with the additional benefits of a PTFE coating for a smoother surface and reduced friction.

Nylatron® Nylon

Durable, lightweight composite material that has high mechanical strength and stiffness, resists static electricity, and has excellent wear resistance.

PTFE-Coated

PTFE-coating, along with anodizing, protects aluminum against corrosion by sealing the surface from moisture. It also minimizes friction and gives the component better wear resistance.

Stainless Steel

17-4 PH Stainless Steel: this alloy is used in gears because it is hardenable to extremely high strengths. 17-4 PH is more corrosion-resistant than any other standard hardenable stainless steel.

316 Stainless Steel: this is a nonhardenable alloy with high corrosion resistance in freshwater and saltwater.

XM-19 Stainless Steel: this stainless is highly alloyed, with very high mechanical strength and superior corrosion resistance. Rods and pins in Harken cylinders are made of XM-19 stainless.

Titanium

This lightweight, hard metal has the highest strength-to-weight ratio of any metal. Its corrosion rate is so low that after 4000 years in seawater, corrosion would only have penetrated to the thickness of a thin sheet of paper. Harken uses titanium rollers in V blocks to handle bearing loads.

Torlon® Thermoplastic

Exceptionally strong crush/impact-resistant bearing material that withstands heavy long-term use and shock loading. Most Harken hardware that sees extreme loads uses greenish-brown Torlon® bearings.

UV-Stabilized

UV light photo-degrades composites by breaking their chemical bonds, leaving them weak, brittle, and discolored. This is common in equipment with white bearings. All Harken composites and bearings are naturally UV-resistant or use stabilizers like carbon black.

Zirconia (Ceramic)

Zircon bearings are more than 700% stronger in compression than stainless bearings of the same size. So, they won't deform if used within the recommended load limits. For the same bearing sizes, ceramic withstands incredible compression loads, but beyond the limit, they tend to crush not flatten.



Hardcoat-anodized

Clear-anodized

6061-T6 Aluminum Anodizing Thickness

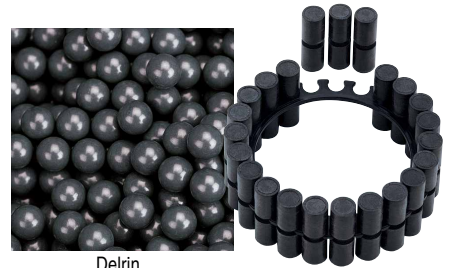
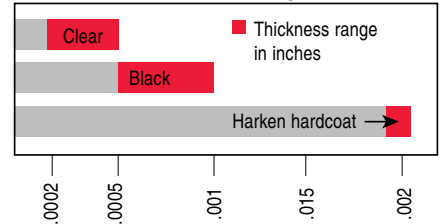

Delrin



Zirconia (Ceramic)

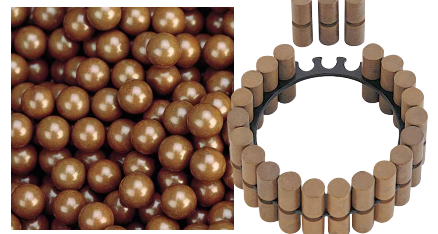

Torlon



Not UV-stabilized

UV-stabilized

For complete listing, see www.harken.com/glossary

Delrin is a registered trademark of E. I. du Pont de Nemours and Company or its affiliates.

Nylatron is a registered trademark of Quadrant EPP USA Inc.

Torlon is a registered trademark of Solvay Advanced Polymers, L.L.C.

Worldwide Limited Warranty

COVERAGE. HARKEN warrants that each HARKEN product, when properly used and maintained, will be free from defects in material and workmanship from the date of receipt of the product by the final customer. HARKEN products are covered by two different kinds of warranties, on the basis of the purchaser and use made of them.

1. The Private Customer Warranty

2. The Professional Customer Warranty

THE LIMITED PRIVATE CUSTOMER WARRANTY. This limited warranty applies to all Harken products purchased for final use by private individuals only and installed on boats used exclusively for recreational purposes. Harken products installed on boats used for any other purpose or by any other entity are covered by the limited PROFESSIONAL CUSTOMER WARRANTY. The Owner's sole and exclusive remedy under this limited PRIVATE CUSTOMER WARRANTY for original defects in materials or workmanship of a HARKEN product shall be the repair or replacement, in HARKEN's sole discretion, of the defective part or component, at no charge to the owner of the product.

THE LIMITED PROFESSIONAL CUSTOMER WARRANTY. This limited warranty applies to all Harken products purchased for final use by or on behalf of any entity other than a private individual (such as by corporations, partnerships, competitive race groups, etc.) or installed on boats used for any purpose other than recreational use, such as for hire, charter or other professional or commercial events or activities. Such Professional Customers may include, but are not limited to, America's Cup Syndicates, international competitive syndicates, racers in transoceanic and globe-circling events, one-design racers with boats 40 feet and up racing in major competitive and international competition.

The Owner's sole and exclusive remedy under this limited PROFESSIONAL CUSTOMER WARRANTY for original defects in materials or workmanship of a HARKEN product shall be the repair or replacement, in HARKEN's sole discretion, of the defective part or component, in accordance with the terms of this warranty.

WARRANTOR. For products originally sold in the United States, the limited warranty for the products is supplied by HARKEN, INC.. For products originally sold in the European Union, the limited warranty for the products is supplied by the dealer who sold the product through the Harken Distributors in that country. For products originally sold in the rest of the World, the limited warranty for the products is supplied directly by the Harken Distributors in that country. When "HARKEN" is mentioned throughout this Limited Warranty, it refers to the entity as defined in this paragraph.

OWNER – NON-TRANSFERABLE WARRANTY. This warranty is made by HARKEN with only the original purchaser of the product and does not extend to any third parties. The rights of the original purchaser under this warranty may not be assigned or otherwise transferred to any third party.

WARRANTY TERM. The limited PRIVATE CUSTOMER WARRANTY covers any original defects in material or workmanship manifested within five (5) years of the date of receipt of the product by the final customer.

However, the warranty terms under the limited PRIVATE CUSTOMER WARRANTY for the following products are as indicated below by the date of receipt of the product by the final customer:

1. Jib Reefing and Furling systems are warranted for seven (7) years. Hydraulic and Electric Furling systems are warranted for five (5) years. Electric furling motor, switches, control boxes, and breakers are warranted for two (2) years.
2. Reflex furler for asymmetric and code zero sails, associated adapters, cable terminals/clamps, and fairlead kits, are warranted for three (3) years. Reflex torsion cable is warranted for one (1) year.
3. Carbo Racing Foils are warranted for three (3) years.
4. Winches and handles, cylinders, valves, pumps, reservoirs, control panels are warranted for three (3) years. Electric/hydraulic winch motors, captive reel winches, CLR mooring winches, hydraulic power units, switches, control boxes, and breakers are warranted for two (2) years.
5. Custom products, pedestals, gearboxes, push buttons, drive shafts, carbon fiber products, and/or high performance applications of standard catalog products for extraordinary use applications are warranted for two (2) years.
6. Harken gloves, sunglasses, and related accessories are warranted for two (2) years from date of purchase. Warranty excludes normal wear and tear.

The limited PROFESSIONAL CUSTOMER WARRANTY covers any original defects in material or workmanship manifested within 12 months of the date of receipt of the product by the final customer.

NOT COVERED. Neither the limited PRIVATE CUSTOMER WARRANTY nor the limited PROFESSIONAL CUSTOMER WARRANTY applies to, nor shall HARKEN have any liability or responsibility for, damages or expenses relating to defects caused by misuse, abuse, failure to install, use, maintain, or store the HARKEN

product as specified in the warranty booklet, service booklet, manuals, catalogue, or other literature available from HARKEN.

Neither the limited PRIVATE CUSTOMER WARRANTY nor the limited PROFESSIONAL CUSTOMER WARRANTY applies to, and neither HARKEN shall have any liability or responsibility in respect of, damages or expenses relating to:

- defects in material or workmanship that did not exist when the product was first delivered;
 - defects in material or workmanship that are manifested outside the warranty period;
 - defects which are not reported to HARKEN within sixty (60) days of discovery;
 - a product that has been altered or modified from factory specifications;
 - damage or deterioration of cosmetic surface finishes, including cracking, crazing, discoloration, or fading;
 - accidents, misuse, abuse, abnormal use, improper use, lack of reasonable or proper maintenance or storage;
 - installation, wiring, service, or repairs improperly performed or replacement parts or accessories not conforming to HARKEN's specifications;
 - use exceeding the recommended and permitted limits or loads of the product and/or the vessel on which the product is installed;
 - normal wear or deterioration occasioned by the use of the product or its exposure to the elements;
 - besides HARKEN's Hoister products used to store watercraft and bicycles, any use outside, other than or besides normal sailing or sailboat applications;
 - ropes, lines, soft attachments, buckles, and webbing;
 - clear coat finishes on carbon fiber;
 - loss of time, loss of use, inconvenience, travel expense, costs related to procuring any substitute boat, transportation costs, towing costs, any incidental or consequential damages arising out of the non-use of the boat, or compensation for inconvenience or loss of use while the boat is being repaired or otherwise not available, or other matters not specifically covered hereunder;
 - the costs to remove, disassemble, or re-install the product;
 - the costs or expenses associated with transporting the product to and from HARKEN or a HARKEN dealer
 - hauling out, storage, and relaunching of the boat on which the product has been installed, even where this is necessary to carry out the warranty service.
- The limited PROFESSIONAL CUSTOMER WARRANTY does not cover, nor shall HARKEN have any liability or responsibility in respect of, damages or expenses relating to, the following products and/or components:
- pawls and pawl springs in winches;
 - components and gears in titanium;
 - washers and spacers;
 - winch drum grip;
 - ball bearings, roller bearings, thrust bearings;
 - winch handles.

PROCEDURE. In the event of a defect covered by this limited warranty, the Owner shall contact one of HARKEN's worldwide Distributors (there is a list of them on the www.harken.com site). If the product was originally sold in European Union the Owner shall contact the dealer that sold the product. To obtain warranty service for or replacement of your HARKEN product, your specific and detailed claim must be reported to and received by HARKEN, in writing, in accordance with the terms of this warranty and within the applicable warranty period. Also provide your name, address, phone number, original sales receipt, a description of the application of the product, and an explanation of the defect and conditions under which the product was used. If the examination of the product and the warranty claim reveals that the defect is not covered by this warranty, you will be contacted and advised of the cost of repair of your product. If you accept this estimate, the product will be repaired outside of this warranty.

DAMAGES OR OTHER COSTS. Except as expressly provided by this warranty, HARKEN SHALL NOT BE RESPONSIBLE FOR ANY INCIDENTAL OR CONSEQUENTIAL DAMAGES OR OTHER COSTS, WHETHER THE CLAIM IS BASED IN CONTRACT, TORT, OR OTHERWISE, including but not limited to any costs, taxes, fees, levies, or other expenses imposed by any location in which the product was originally sold. The foregoing statements of warranty are exclusive and in lieu of all other remedies. Some jurisdictions do not allow the exclusion or limitation of incidental or consequential damages, so this limitation or exclusion may not apply to you.



Worldwide Limited Warranty

DISCLAIMER. ANY IMPLIED WARRANTY OF MERCHANTABILITY OR FITNESS FOR A PARTICULAR PURPOSE AND ALL IMPLIED WARRANTIES ARISING FROM A COURSE OF DEALING, USAGE OF TRADE, BY STATUTE OR OTHERWISE, IS HEREBY STRICTLY LIMITED TO THE TERM OF THIS WRITTEN LIMITED WARRANTY. This Agreement shall be the sole and exclusive remedy available to the Owner with respect to this product. In the event of any alleged breach of any warranty or any legal action brought by the purchaser based on alleged negligence or other tortious conduct by HARKEN, the Owner's sole and exclusive remedy will be repair or replacement of defective materials as stated above. No dealer and no other agent of HARKEN is authorized to modify, extend, or enlarge this warranty.

APPLICABLE LAW. This warranty is governed by the laws of the State of Wisconsin for all products originally sold outside European Union. This warranty is governed by the laws of the Member State of the European Union where the product was originally sold. The exclusive jurisdiction and venue for any court action commenced by you under or relating to this limited warranty or any implied warranty(ies) shall be decided in the Courts of Waukesha County, Wisconsin or in the competent European Union State Member Court if the product was originally

sold in European Union. In the event HARKEN prevails in any court action, the claimant shall reimburse HARKEN for the expenses, including attorney fees and expenses of litigation, reasonably incurred by HARKEN in defending against such claim.

OTHER RIGHTS. Claimant's acceptance of delivery of the warranted HARKEN product constitutes acceptance of the terms of this limited warranty. This warranty gives specific legal rights, and claimant may also have other rights under the laws of the jurisdiction involved.

ENTIRE AGREEMENT. This document contains the entire warranty given by HARKEN in respect of your product and supersedes any and all oral or express warranties, statements, or undertakings that may previously have been made. Any and all warranties not contained in this warranty are specifically excluded. There are no terms, promises, conditions, or warranties regarding your product other than those contained herein. HARKEN specifically does not authorize any person to extend the time or scope of this warranty or to create or assume for HARKEN any other obligation or liability with respect to HARKEN products.

June 2008/112616.1

General Warnings and Instructions

Sailing is an exciting sport that can provide hours of enjoyment for you, your family, and friends. However, there are risks inherent in the sport, as well as with the equipment involved, that must be respected in order to avoid an accident, damage to your vessel, personal injury, or death.

WARNINGS AND INSTRUCTIONS. You must carefully read, understand, and follow all of the warnings and instructions provided by Harken in order to avoid an accident. These warnings and instructions can be found on the equipment, in its packaging, in our brochures, on our website, or through our customer service department.

HYDRAULIC EQUIPMENT WARNING. Pressurized hydraulic cylinders can be dangerous and if handled improperly may explode, possibly causing an accident, damage to your vessel, personal injury or death. Cylinders should only be serviced by a thoroughly trained and equipped hydraulic technician following the instructions in the manual.

TRAINING AND EXPERIENCE. Even though Harken equipment appears simple and easy to operate (as intended by our design), our equipment should never be used unless you have a sufficient level of training and experience in sailing in general and with the equipment in particular.

The amount of training and experience depends on a number of factors, including the size and type of your vessel, the weather conditions, and the task you are trying to complete. If you have any doubt whatsoever about your training or experience, please do not use the equipment. Please contact Harken or seek additional training.

AVOID ACCIDENT & INJURY. Regardless of your skill level, in order to avoid an accident, damage to your vessel, personal injury, or death:

1. Loads on hardware can be significant, and shock loading from heavy winds or seas can quickly multiply that load to extremely high levels. Maximum line diameter is a guide to sheave groove size and not intended to provide the maximum working load of the block. All persons selecting, installing, or maintaining Harken gear must be aware and cautious of such loads.

Select appropriate Harken hardware by using the loading formulas and charts provided in the Harken catalog or online at www.harken.com.

Always confirm your selection with a rigging professional or contact Harken directly.

2. Never, under any circumstances, exceed the capacity or Maximum Working Load (MWL) of any piece of equipment. The maximum working load may be found in our catalog, on our website, or through our technical service department. Loads above the

MWL can cause the equipment to fail suddenly and unexpectedly.

The Breaking Load (BL) is the load at which a product is likely to fail. It is much higher than the highest load a product should ever experience, and should not, under any circumstances, ever be considered in selecting equipment. It is published for informational purposes only.

3. Harken hardware and winches shown in the Harken catalog and the harken.com website are designed and engineered for use on sailing boats for normal sailboat applications for rigging. **Do not use Harken equipment for human suspension unless product is specifically certified and labeled for such use.** Aloft rigging and maintenance must be left to rigging professionals only. For non-sailing applications consult the HarkenIndustrial.com website and consult with experts at Harken regarding product certification prior to using for human suspension.

4. Keep fingers, hands, hair, loose clothing, gloves, and tools away from moving parts.

5. If you are securing any equipment to the vessel with screws or other fasteners, be sure you are installing the screw into solid structure, or that you use anchor bolts, and that the attachment is sufficient to hold the anticipated load. Otherwise, the screw could become loose over time, or otherwise fail unexpectedly, resulting in an accident.

6. NYLOK® nuts must not be used after being removed three times. When you replace shackles and fasteners, use the correct Harken parts to maintain the proper strength.

7. Always have all components of your vessel, down to the smallest pulleys, inspected for wear, corrosion, or deterioration at least yearly, and replace as necessary.

8. Before manipulating any piece of equipment, be sure that all persons and objects are clear of the path of movement of all reacting components.

9. As part of your maintenance procedures and to keep your equipment in optimum working order, frequently flush it with fresh water.

10. Always wear a personal flotation device and/or harness while on board any vessel, and especially while manipulating equipment.

11. Always be sure all safety equipment and electronics are in good working order before you set out on your journey.

12. For general boating safety information, visit the maritime organization in your sailing destination country (such as the United States Coast Guard at www.uscgboating.org).

Nylok is a registered trademark of Nylok Corporation.

Harken Trademarks

Following is a non-exhaustive list of Harken, Inc. trademarks and registered trademarks in the U.S. and other countries and the corresponding product.

The list is updated from time to time. The absence of a trademark or associated product from this list does not constitute a waiver of Harken, Inc. trademark or other intellectual property right concerning that word or logo.

Registered Trademarks	Product
Air®	block, runner block, foil, sheave, winch
Black Magic®	block, Air® block, glove
Cam-Matic®	cleat
Carbo®	block, racing foil, ratchet block, Ratchamatic® block, fiddle block
Carbo-Cam®	cleat
Harken®	blocks, ratchet blocks, sheaves, cleats, fairleads, shackles, padeyes, mainsheet and genoa lead traveler cars and track, batten cars and track, furling systems, foils for raising and lowering racing sails, winches, hydraulic systems including hydraulic cylinders, valves, lines, manifolds, transmissions, and pumps; manual hoists; rope ascenders and descenders; elevating rope work platforms and life-saving safety mechanisms; covers for boats and equipment; duffel bags, sport bags; gloves, shirts, headwear; after-sun lotions, lip balms, sunscreen preparations
Hexaratchet®	block, sheave
PowerSeat®	ascender
Radial Line®	winch
Ratchamatic®	block

Trademarks	Product
Bullet™	block
CLR™	winch
Crossbow™	pivoting self-tacking jib traveler, traveler
Element™	block, shackle block
FlatWinder™	block, powered block
Fly™	block, soft-attach block
Performa™	winch
Protexit™	block, through-deck block
Reflex™	furling, top-down furling
Rewind™	winch, Radial Line® winch
T2™	soft-attach block, block, loop block
UniPower™	winch, Radial Line® winch
V™	block, soft-attach block
Zircon™	block





Maintenance

Harken equipment is designed for minimal maintenance. However, some upkeep is required to give the best service and comply with the Harken limited warranty. Harken installation manuals are available at no charge online at www.harken.com or by contacting a Harken dealer.

Always flush frequently with fresh water and periodically inspect all products for damage.

Do not let deck hardware come in contact with teak cleaner or other caustic solutions as this causes discoloration and damage to the finish.

Product	General Information	Inspection	Cleaning	Lubrication	Fasteners
Small Boat and Midrange Blocks	Tape cotter rings to prevent snagging. Do not leave heavy loads on blocks when not in use as this may slightly deform the bearings. Normally bearings will return to their proper shape after rotation, but an initial resistance to rolling may be felt.	1	4 5		11
Big Boat Blocks	Big Boat bearings are resistant to deformation, but we recommend releasing heavy loads on any hardware when not in use.	1	4 Black Magic Air blocks disassembled, solution on rollers		12
Cambs			4 Apply to bearings		11 On cam screws
Travelers and Battcars		1	4 Apply to bearings	7 On balls 8 Slider cars only	11 On bolts 13
Furling	Refer to the owner's manual for detailed maintenance instructions.	2	4 Apply to bearings		14 On all foil connector screws
Winches	Refer to the owner's manual for detailed maintenance instructions. Over application of grease can cause salt and water deposits to become trapped in the winch. Clear drain ports of sealants or grease. Lubricate pawls with Harken Pawl Oil. Do not grease pawls.	3	4 Plastic parts 4 Winch top 6 Metal parts	9 On gears 10 On pawl	12 On socket bolt 13
1	Inspect frequently: shackles and shackle posts for signs of corrosion, cracks, or elongation. Inspect: lashings and loops for UV damage, wear, or chafe. When replacing loops, lashings, or shackles, use Harken parts to maintain the proper strength.				
2	Inspect frequently: wire terminals, turnbuckle components, toggles, shackles, clevis and cotter pins below and inside drum assembly for signs of loosening, corrosion, or cracks.				
3	Check for wear and corrosion: Check pawls and springs, bearings, gears, and spindles.				
4	Clean: Keep your equipment clean and free-running by frequently flushing with fresh water. Periodically clean with mild detergent and water solution. Spin sheaves, rotate cams, and roll cars back and forth to distribute soap solution evenly.				
5	Clean: with Scotch Brite® pad on Classic block sideplate and stainless steel strap.				
6	Degrease: Remove grease with degreaser. Harken recommends environmentally friendly citrus degreasers.				
7	Condition: Use only a single drop of McLube OneDrop™ ball bearing conditioner. Too much oil attracts dirt.				
8	Lubricate: Dry lubricants such as McLube® Sailkote, dry PTFE, and dry silicon sprays which will not attract dirt may be used on slider cars.				
9	Grease lightly: with Harken winch grease.				
10	Lubricate: winch pawls with a drop of Harken Pawl Oil. Do not grease winch pawls.				
11	Adhesive: Blue Loctite®. Temporary adhesive. Can be removed without heating.				
12	Anti-seize: Coat stainless fasteners that pass through aluminum blocks with an anti-seize compound such as Tef-Gel®.				
13	Replace: lock nuts after the third removal.				
14	Adhesive: Red Loctite®. Semi-permanent adhesive. Can be removed with heat. Electric heat gun will not raise temperature enough to break adhesive seal.				

McLube is a registered trademark of McGee Industries, Inc. Loctite is a registered trademark of Henkel AG & Company KGaA. Scotch Brite is a registered trademark of 3M Company. Tef-Gel is a registered trademark of Ultra Safety Systems, Inc.

Genoa Lead Cars

Part numbers represent hardware most commonly used.

Typical boat length:

Small Boat: 6.7 - 8.5 m (22 - 28')
 Midrange: 8.8 - 10.4 m (29 - 34')
 Big Boat: 10.7 - 12.8 m (35 - 42')

Diagram Ref.	Description	Small Boat Part No.	Midrange Part No.	Big Boat Part No.
Pinstop Slider				
A	Lead car	G226S	G276S	G326S
B	Cheek	6237	6267	6294
C	Track	2751	R27	R32
Multi-Track				
A	Lead car	G226S	G276S	G326S
B	Track	2751	R27	R32
C	Lead car	G222B	G273B	G323B
D	End control	2740	E2750	E3250
E	Track	2720	R27	R32
F	Footblock	6267	3220	3234
G	Endstop	E2200	E2700	E3200
H	Cheek	350	2644	6106
I	Cam cleat	365	150	280
Barbahauler				
A	Lead car	G2227B	G2737B	G3247B
B	End control	2740	1632	3169
C	Track	2720	R27	R32
D	Endstop	E2200	E2700	E3200
E	Cheek	350	2644	6237
F	Cam cleat	365	150	150
Beachcat Jib Controls				
	Multihulls	2.4 - 4.3 m (8 - 14')	4.6 - 6.4 m (15 - 21')	—
A	Single	348	2636	—
B	Single	2611	2628	—
C	Cheek	350	2644	—
D	Cam cleat	468	150	—
Crossbow				
A	Crossbow	2758.1.1M.50	—	—
B	Single	2149	—	—
C	Single	404	—	—
D	Cheek	416	—	—
E	Single	2698	—	—
F	Cam Base	240	—	—

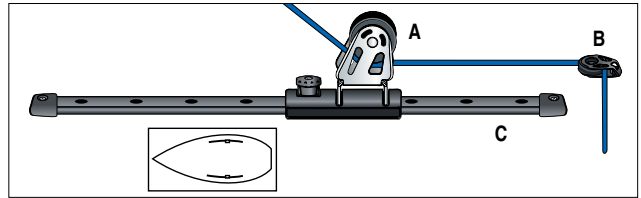

Pinstop Slider: A pinstop slider car on ball bearing track is recommended for cruising boats that might upgrade to adjustable ball bearing cars.

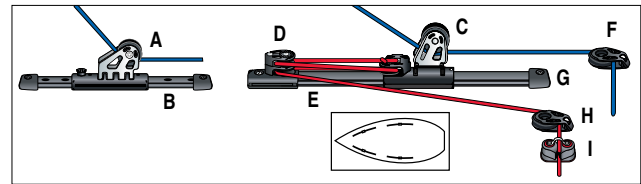

Multi-Track: Use an adjustable car for the #1 and #2 genoas. Use a pinstop car for the #3 and #4 jibs. Adjust the forward car with a pinstop slider.

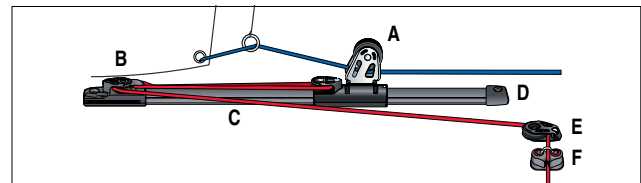

Barbahauler: Use this low-profile system on racing boats with nonoverlapping jibs like the Farr 40 and One Design 35. An inhaul is used to control slot size.

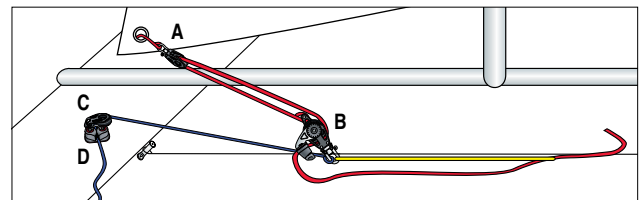

Beachcat Jib Controls: This jib traveler is used to haul the jib sheet block outboard for slot adjustment on multihulls up to 6.4 m (21').

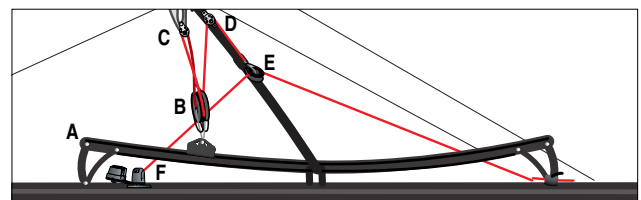

Crossbow: The Crossbow is a self-tacking jib system designed for high-performance dinghies, skiffs, and catamarans under 6 m (20').

Traveler

Part numbers represent hardware most commonly used.

Standard boat length*:

Small Boat: 6.7 - 8.5 m (22 - 28')
 Midrange: 8.8 - 10.4 m (29 - 34')
 Big Boat: 10.7 - 12.8 m (35 - 42')

*Refer to Ordering Mainsail Travelers for in-depth specifications by boat type.

Diagram Ref.	Description	Small Boat Part No.	Midrange Part No.	Big Boat Part No.
2:1 Cam on Car				
A	Traveler	2734	—	—
B	Track	2720	—	—
C	Eyestraps	073	—	—
3:1 Windward Sheeting				
A	Traveler	2745	1635	—
		2746	1636	—
B	End control	2740	1631	—
C	Track	2720	R27	—
4:1 Windward Sheeting				
A	Traveler	—	1635	3177
B	End control	—	1631	3168
C	Track	—	R27	R32
2:1 Remote Cleat				
A	Traveler	2728	—	—
B	Eyestraps	137	—	—
C	Track	2720	—	—
D	Cam cleat	150	—	—
Standard 3:1				
A	Traveler	2731	T2731B	T3231B
B	Control block	348	—	—
C	End control	2743	E2756	E3256
D	Track	2720	R27	R32
Standard 4:1				
A	Traveler	2727	T2742B	T3242B
B	Control block	342	—	—
C	End control	2743	E2756	E3256
D	Track	2720	R27	R32
2:1 with Dedicated Winch				
A	Traveler	—	—	T3222B.HL
B	End control	—	—	E3230.HL
C	Winch	—	—	46.2STA
D	Track	—	—	R32

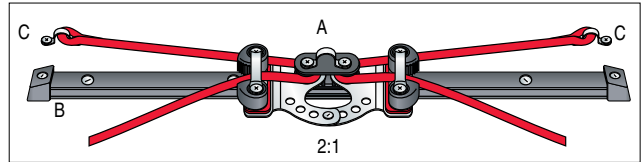

2:1 Cam on Car: This system features cleats on adjustable arms that can be angled. On flush-deck boats, face cleats down the length of the track. On boats with seat backs, angle the cleats forward or aft.

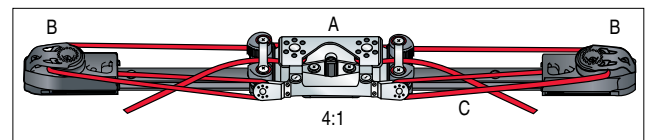
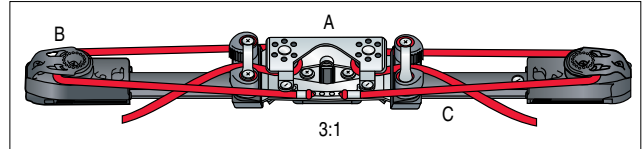

Windward Sheeting: The windward sheeting traveler lets crew pull the car above the centerline without releasing the leeward control line. Tack and the car stays in the same position, ready to be pulled to the new windward side.

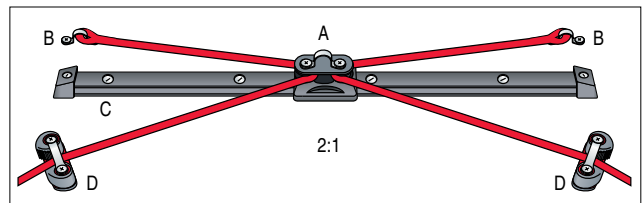

2:1 Remote Cleat: Use this 2:1 system on flush-deck boats like the J/24 where crew sit outboard of the traveler and loads are nearly vertical.

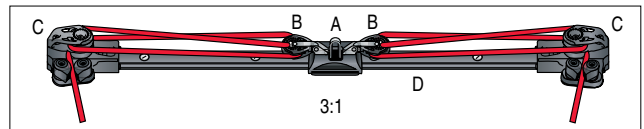

Standard 3:1: This system, with cleats on the track, is used on boats under 10.7 m (35').

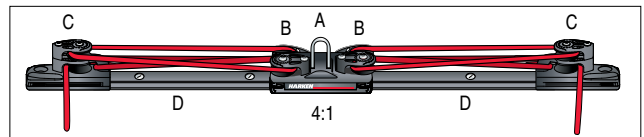

Standard 4:1: This 4:1 system is used on moderately-sized cruising and racing boats. Control blocks and cleats mount on track ends.

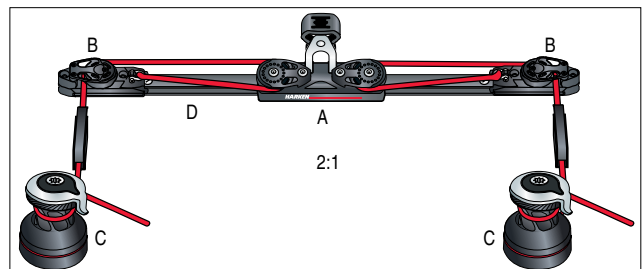

2:1 with Dedicated Winch: Install this system on big boats when winches are used to adjust the traveler.

Traveler

Part numbers represent hardware most commonly used.

Standard boat length*:

Small Boat: 6.7 - 8.5 m (22 - 28')
 Midrange: 8.8 - 10.4 m (29 - 34')
 Big Boat: 10.7 - 12.8 m (35 - 42')

*Refer to Ordering Mainsail Travelers for in-depth specifications by boat type.

Diagram Ref.	Description	Small Boat Part No.	Midrange Part No.	Big Boat Part No.
4:1 Remote Cleat				
A	Traveler	2727	T2742B	T3242B
B	Control block	342	—	—
C	End control	2742	E2750	E3250
D	Track	2720	R27	R32
E	Cam cleat	150	150	150
		—	365	—
3:1 Remote Cleat				
A	Traveler	2727	T2703B	T3203B
B	Control block	341	2637	2601
C	Upright block	220	220	223
D	Cam cleat	150	150	150
		—	365	—
E	Track	2720	R27	R32
Underdeck Traveler Control				
A	Traveler	—	—	T3203B.HL
B	Track	—	—	R32
C	Single	—	—	3215
D	Triple	—	—	2605
E	Triple	—	—	2604
F	Upright block	—	—	222
G	Cam cleat	—	—	150
H	Padeye	—	—	627
4:1 Dodger Block				
A	Traveler	—	—	T3242B
B	End control	—	—	E3250HB
C	Track	—	—	R32HB
D	Track riser	—	—	1849
E	Halyard lead block	—	—	1986
F	Cam cleat	—	—	458

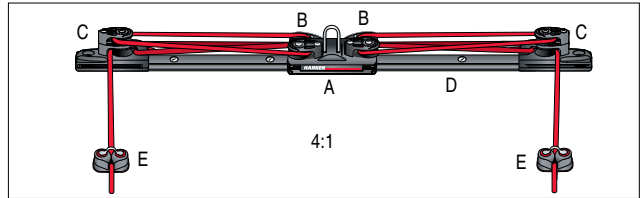

4:1 Remote Cleat: If the traveler is mounted ahead of the companionway, place the cleats at the aft-edge of the cabin house.

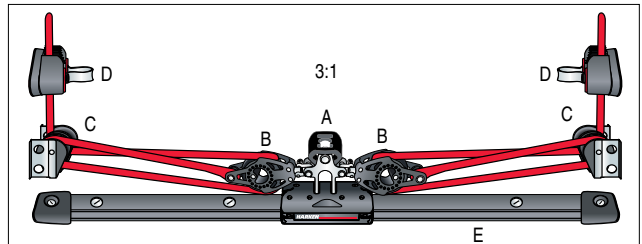

3:1 Remote Cleat: When the crew sits above the traveler, lead control lines up the cockpit sides to a convenient cleat on the coaming.

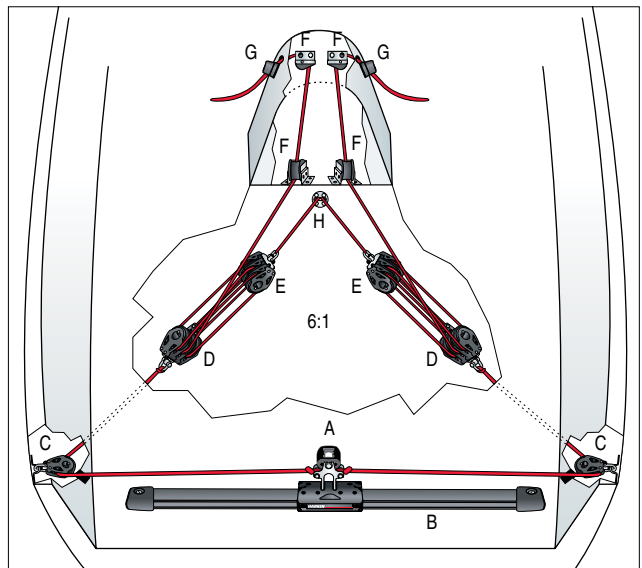

Underdeck Traveler Control: Racing boats often keep decks clean by running the traveler tackle belowdeck. This system has a 6:1 purchase that exits at a central control pod forward of the wheel or tiller, which allows the mainsheet trimmer to easily adjust the traveler. Popular on boats like the Farr® 40.

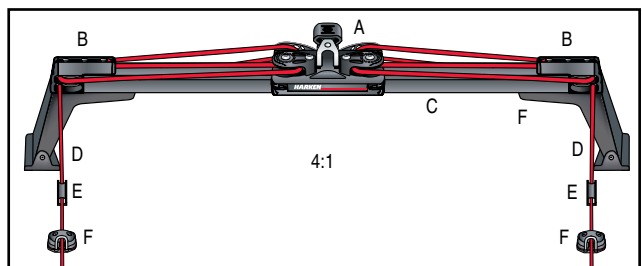

4:1 Dodger: This system works well with a dodger.

Mainsheet

Part numbers represent hardware most commonly used.

Typical boat length:

Small Boat: 6.7 - 8.5 m (22 - 28')
 Midrange: 8.8 - 10.4 m (29 - 34')
 Big Boat: 10.7 - 12.8 m (35 - 42')

Diagram Ref.	Description	Small Boat Part No.	Midrange Part No.	Big Boat Part No.
4:1 Fiddle				
A	Fiddle	2621	2690	1559
B	Fiddle	2676	2697	1566
6:1 Reeved Right Angle				
A	Triple	2604	2664	1546
B	Triple	2141	2686	1556
8:1 Beachcat				
	Multihulls	2.4 - 4.3 m (8 - 14')	4.6 - 6 m (15 - 20')	6.4 - 9 m (21 - 30')
A	Quad	2654	2631	2677
B	Triple	2619	2632	2687
4:1 Swivel Base				
A	Single	2600	2660	1540
B	Single	2601	2661	1541
C	Single	2135	2670	1549
D	Cam base	205	144	1574
4:1/16:1 Gross/Fine				
A	Single	2636	2600	2660
B	Double	381	2642	2602
C	Fiddle	2658	2676	2697
D	Fiddle	2675	2696	1565
4:1/16:1 Double-ended Fine Tune				
A	Single	2636	2600	2660
B	Single	2135	2135	1549
C	Cam base	205	144	1574
D	Double	342	2638	2602
E	Single	349	2652	2600
F	Cam cleat	471	471	150
6:1/24:1 Gross/Fine				
A	Double	2638	2602	2662
B	Triple	2647	2629	1555
C	Single	2636	2600	2660
D	Fiddle	2655	2621	2690
E	Fiddle	2676	2676	2697
6:1/24:1 Cascaded				
A	Triple	2640	2604	2664
B	Triple	2617	2629	2685
C	Double	2638	2638	2602
D	Fiddle	2658	2658	2676

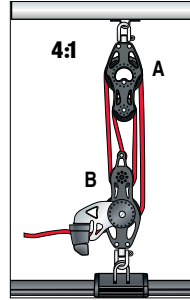

4:1 Fiddle: This 4:1 tackle is the most common system on boats under 8.5 m (28').

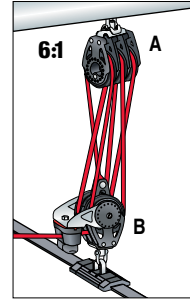

6:1 Reeved Right Angle: Boats with mainsails to 35 m² (375 ft²) often use a 6:1 system.

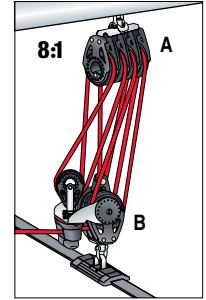

8:1 Beachcat: This 8:1 purchase handles high mainsheet loads on Beachcats up to 6 m (20').

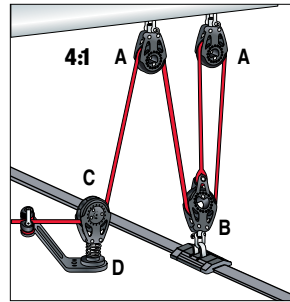

4:1 Swivel Base: Position the swivel base block off the traveler car to allow mainsail adjustment without dragging the car to windward in light air. To avoid tightening the leech, curve the track ends up.

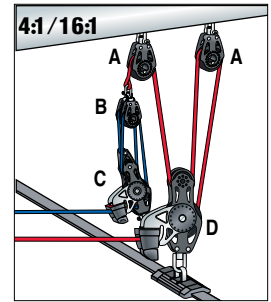

4:1/16:1 Gross/Fine: This powerful gross-trim/fine-tune cascading system allows crew to use the 4:1 gross-trim for most trimming and the 16:1 fine-tune for precise adjustments.

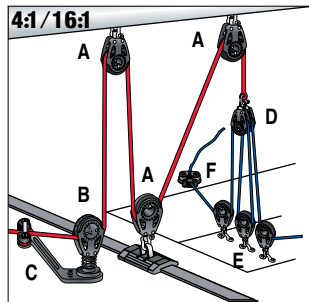

4:1/16:1 Double-ended Fine Tune: This 4:1/16:1 system uses a dinghy-like double-ended tackle that locates the sheet ends on the cockpit sides.

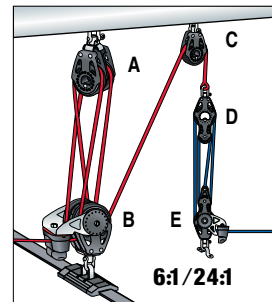

6:1/24:1 Gross/Fine: This 6:1/24:1 cascading system is used on boats with end-boom sheeting and mains as large as 25.5 m² (275 ft²) and end-boom sheeting.

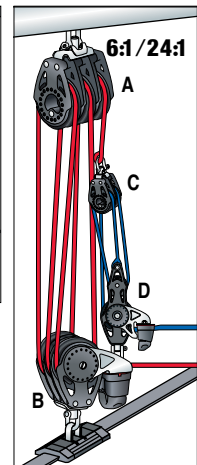

6:1/24:1 Cascaded: This 6:1/24:1 system is used on boats with mains as large as 25.5 m² (275 ft²) and end-boom sheeting.

Mainsheet

Part numbers represent hardware most commonly used.

Typical boat length:

Small Boat: 6.7 - 8.5 m (22 - 28')
 Midrange: 8.8 - 10.4 m (29 - 34')
 Big Boat: 10.7 - 12.8 m (35 - 42')

Diagram Ref.	Description	Small Boat Part No.	Midrange Part No.	Big Boat Part No.
7:1 / 28:1 Gross/Fine				
A	Single	—	2600	2660
B	Triple	—	2629	2685
C	Straphead	—	2650	2650
D	Triple	—	2604	2664
E	Fiddle	—	2655	2621
F	Cheek	—	2644	2606
G	Through-deck	—	046	047
H	Pivoting lead	—	2156	2156
4:1 with Dedicated Winch				
A	Single	—	6260	3231
B	Fiddle	—	6292	3241
C	Single w/becket	—	6261	3232
D	Footblock	—	6267	3234
E	Winch	—	40.2ST	46.2ST
5:1 with Dedicated Winch				
A	Single	2660	1540	3231
B	Fiddle w/ becket	2691	1560	3242
C	Footblock	1548	1548	3234
D	Winch	35.2ST	46.2ST	46.2ST
2:1 with Dedicated Winches				
A	Single	—	1586	3231
B	Single	—	1540	3215
C	Footblock	—	1548	3220
D	Winch	—	40.2ST	46.2ST
Admiral's Cup 2:1 with Dedicated Winches				
A	Double	—	1544	3233
B	Single	—	1586	3246
C	Single	—	1540	3231
D	Footblock	—	1548	3234
E	Winch	—	35.2ST	46.2ST
3:1 with Dedicated Winch				
A	Single w/becket	—	—	3247
B	Single	—	—	3246
C	Stand-up	—	—	3254
D	Winch	—	—	46.2ST

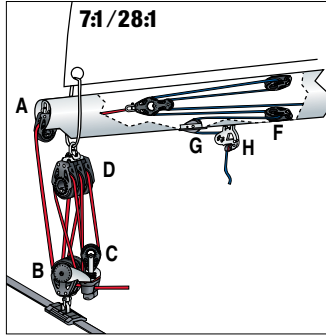

7:1/28:1 Gross/Fine: This gross-trim/fine-tune system is found on racing multihulls where it is desirable to split the gross-trim from the fine-tune. Placing the fine-tune in the boom provides a very clean system that the trimmer can get a hold of and put his weight into. The powerful cascading fine-tune portion is used to haul the boom in that last little bit.

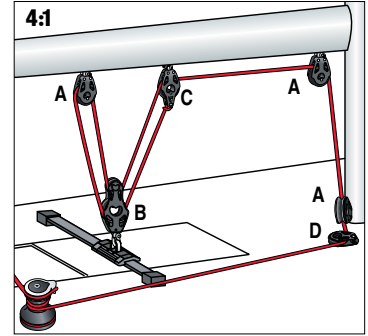

4:1 with Dedicated Winch: This system moves the traveler over the companionway to clean up the cockpit. A favorite on cruising boats.

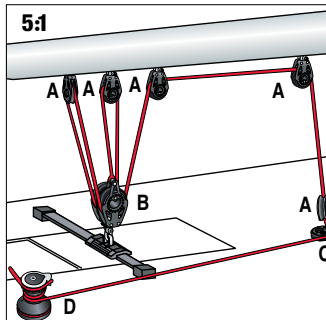

5:1 with Dedicated Winch: This system is popular on cruising boats with cabintop travelers. The sheet leads forward to the gooseneck and then down and back to a winch on the aft edge of the cabintop.

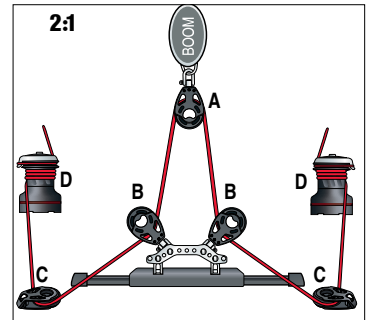

2:1 with Dedicated Winches: This simple double-ended system lets the mainsheet run freely through the blocks which allows the traveler car to move easily. The trimmer makes sail adjustments from the high side.

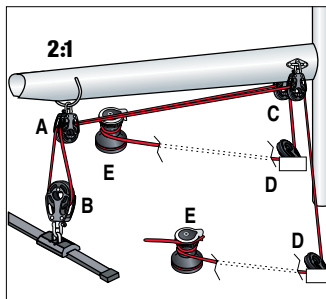

Admiral's Cup 2:1 with Dedicated Winches: In this system, the traveler is independent of the mainsheet so it rolls freely. The sheet leads forward along the boom before it turns down and aft to winches. Used on race boats like the Farr 40.

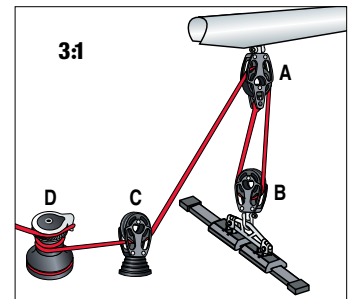

3:1 with Dedicated Winch: Many large boats use this simple 3:1 system. A block on deck turns the sheet to a winch.

Mainsheet

Two-Speed Mainsheets

Part numbers represent hardware most commonly used.

Typical boat length:

Small Boat: 6.7 - 8.5 m (22 - 28')

Midrange: 8.8 - 10.4 m (29 - 34')

Big Boat: 10.7 - 12.8 m (35 - 42')

Diagram Ref.	Description	Small Boat Part No.	Midrange Part No.	Big Boat Part No.
2:1 / 4:1 Swivel Base				
A	Double	2602	—	—
B	Single	2600	—	—
C	Double	2634	—	—
D	Cam base	402	—	—
3:1 / 6:1				
A	Cross block	400	400	—
B	Fiddle	401	401	—
3:1 / 6:1 Swivel Base				
A	Single	2600	2600	—
B	Double	2602	2602	—
C	Double	2634	2634	—
D	Cam base	402	402	—
4:1 / 8:1 Swivel Base				
A	Double	2602	2602	—
B	Cross block	400	400	—
C	Double	2634	2634	—
D	Cam base	402	402	—

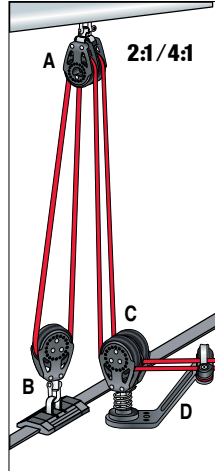

2:1/4:1 Swivel Base: This system is often found on boats like J/24s where a center-mounted swivel base is desired.

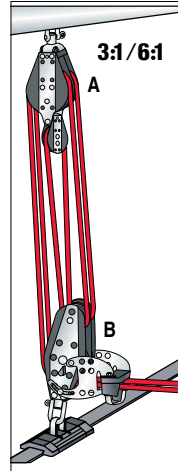

3:1/6:1: This 3:1/6:1 two-speed system is used on end-boom sheeting and mainsails up to 22.3 m² (240 ft²).

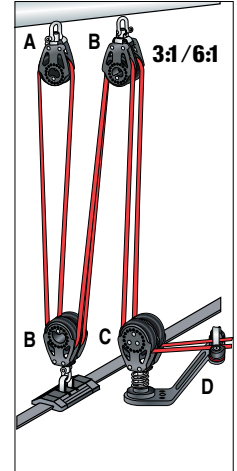

3:1/6:1 Swivel Base: This 3:1/6:1 system allows the mainsheet trimmer to be positioned anywhere on the boat. A great setup for sportboats.

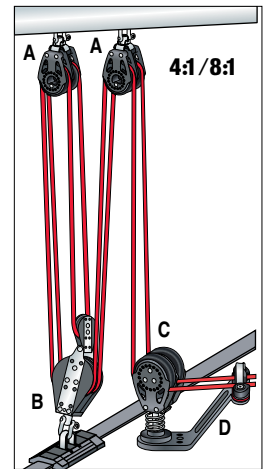

4:1/8:1 Swivel Base: Similar to the 3:1/6:1 swivel base system, but uses a 4:1/8:1 tackle for more power.



Boom Vangs

Part numbers represent hardware most commonly used.

Typical boat length:

Small Boat: 6.7 - 8.5 m (22 - 28')
 Midrange: 8.8 - 10.4 m (29 - 34')
 Big Boat: 10.7 - 12.8 m (35 - 42')

Diagram Ref.	Description	Small Boat Part No.	Midrange Part No.	Big Boat Part No.
4:1 V-Jam				
A	Double	226	—	—
B	Fiddle	245	—	—
4:1 Fiddle				
A	Fiddle	2655	2621	1559
B	Fiddle	2658	2624	1564
8:1 Cascaded Fiddle				
A	Single	300	304	308
B	Fiddle	2655	2621	1559
C	Fiddle	2658	2624	1564
4:1 Cascaded Kicker				
A	Fiddle	2655	2621	1559
B	Fiddle	2658	2624	1564
6:1 Double-ended Cascaded Kicker				
A	Triple	344	2640	2604
B	Double	342	2638	2602
C	Single	349	2652	2600
D	Cam cleat	241	240	240

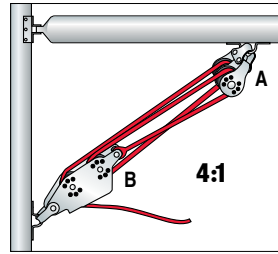

4:1 V-Jam: This simple 4:1 self-cleaning vang is used on small dinghies.

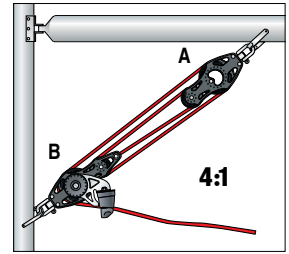

4:1 Fiddle: The basic 4:1 fiddle block vang is commonly used on dinghies and small keelboats.

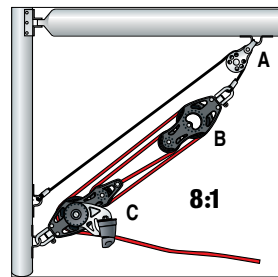

8:1 Cascaded Fiddle: A doubling block increases the purchase of the vang to 8:1. The load on the fiddle blocks is halved so they can be used safely on larger boats.

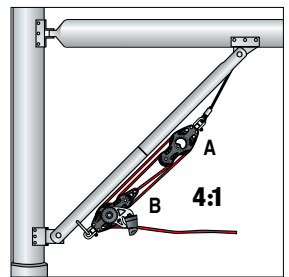

4:1 Cascaded Kicker: This rigid rod vang utilizes a simple 4:1 tackle. The rod also serves as a topping lift for the boom. Used on cruising and racing boats.

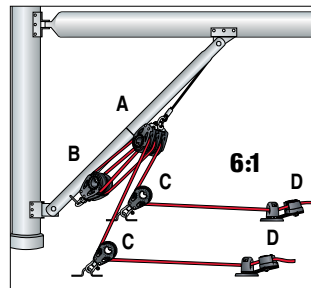

6:1 Double-ended Cascaded Kicker: Many racers rig the vang with a double-ended control line led down each side of the boat.



Outhaul Systems

Part numbers represent hardware most commonly used.

Typical boat length:

Small Boat: 6.7 - 8.5 m (22 - 28')
 Midrange: 8.8 - 10.4 m (29 - 34')
 Big Boat: 10.7 - 12.8 m (35 - 42')

Diagram Ref.	Description	Small Boat Part No.	Midrange Part No.	Big Boat Part No.
2:1 Internal				
A	Through-deck	106	302	306
B	Single	348	2650	2152
C	Through-deck	1200	1202	1203
D	Cam cleat	468	150	150
E	Single	349	2149	2149
4:1 External Cascade				
A	Eyestraps	281	137	1558
B	Cheek	350	2644	2606
C	Single	2146	2148	2152
D	Cam cleat	468	365	150
5:1 Internal				
A	Eyestraps	201	137	1558
B	Fiddle	2655	2621	2690
C	Fiddle	2656	2622	2691
D	Through-deck	1200	1202	1203
E	Through-deck	1200	1200	1200
F	Cam cleat	468	150	150
6:1 Internal				
A	Eyestraps	201	137	1558
B	Double	407	343	2639
C	Triple	408	344	2640
D	Traveler	2727	T2701B	T2701B.HL
E	Through-deck	1200	1202	1203
F	Through-deck	1200	1200	1200
G	Cam cleat	468	150	150
2:1 Furling Main				
A	Clew block	371	—	—
B	Traveler	G222B	1648	3076
C	Through-deck	1200	1202	1203

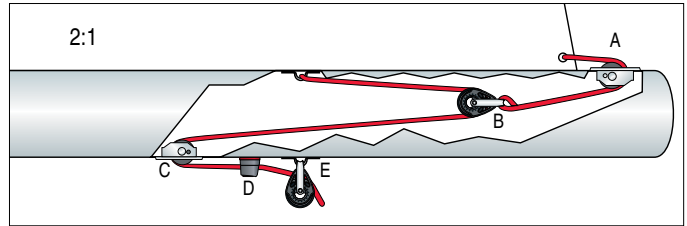

2:1 Internal: Suitable for dinghies or small keelboats. A flexible cable shackles to the sail and enters the boom through a wire block. Placing a block aft of the cleat allows the crew to pull from a variety of positions.

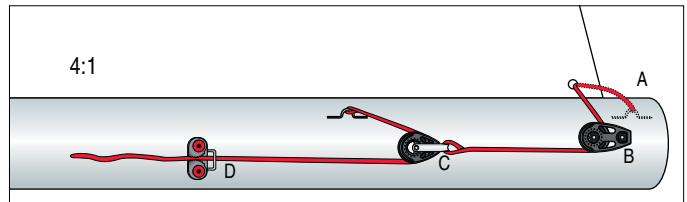

4:1 External Cascade: A simple external outhaul system. A cascade of two 2:1 tackles produces a 4:1 advantage.

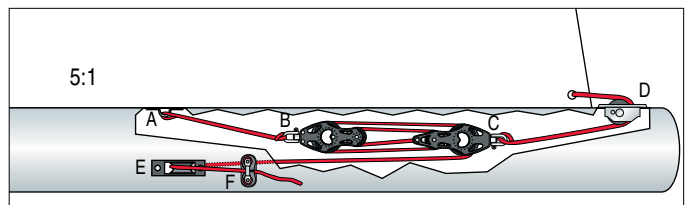

5:1 Internal: This 5:1 internal outhaul is popular on small offshore boats.

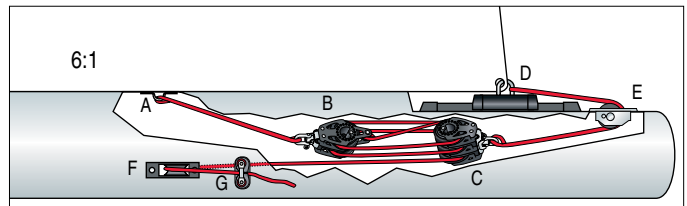

6:1 Internal: A 6:1 internal outhaul system is popular on small-to-medium-sized offshore boats using a traveler car to carry the clew of the mainsail.

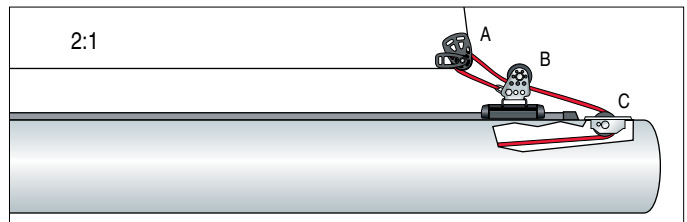

2:1 Furling Main: Mainsails that furl into the mast are loose-footed and usually have a ball bearing outhaul car that rides the length of the boom. The outhaul starts at the car, leads through the clew block on the sail, back to the sheave on the car, and into the boom where it leads to a winch.

Cunninghams

Part numbers represent hardware most commonly used.

Typical boat length:

Small Boat: 6.7 - 8.5 m (22 - 28')
 Midrange: 8.8 - 10.4 m (29 - 34')
 Big Boat: 10.7 - 12.8 m (35 - 42')

Diagram Ref.	Description	Small Boat Part No.	Midrange Part No.	Big Boat Part No.
4:1 Cascaded				
A	Single	2146	2148	—
B	Stand-up	349	2652	—
C	Cheek	350	2644	—
D	Cam cleat	470	458	—
8:1 Cascaded				
A	Fiddle	244	2655	2621
B	Fiddle	245	2658	2624
4:1 Double-Ended Cascaded				
A	Single	348	—	—
B	Pivoting lead	395	—	—
C	Cheek	233	—	—
12:1 Cascaded				
A	Triple	344	2640	2640
B	Triple	347	2648	2648
6:1 Double-Ended Jib Downhaul				
A	Single	2146	2149	2152
B	Cheek	350	2644	2606
C	Cam cleat	468	150	150
D	Bullseye	339	339	237

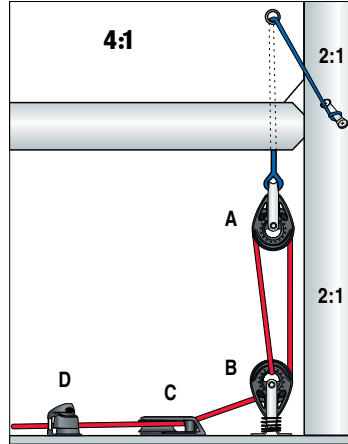

4:1 Cascaded: This simple 4:1 system leads aft to the cockpit. A favorite on small keelboats and daysailers.

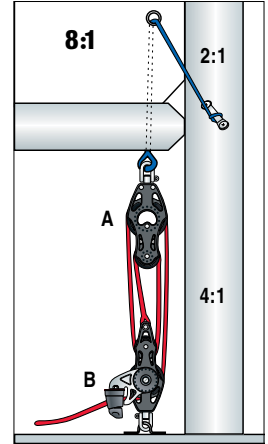

8:1 Cascaded: The most basic cunningham is a self-cleating 8:1 tackle positioned at the mastbase.

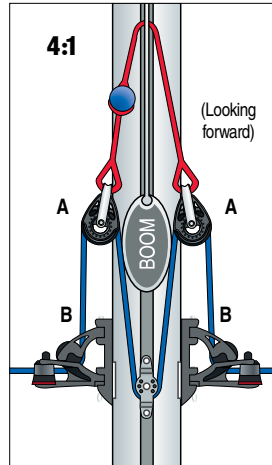

4:1 Double-ended Cascaded: This system is easy to adjust from the trapeze. It's easy to rig and unrig. Popular on smaller beachcats.

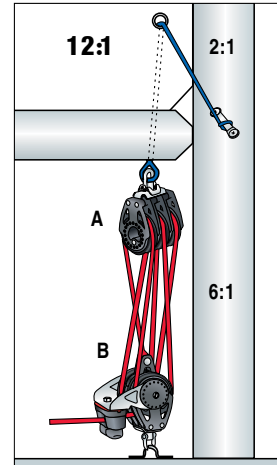

12:1 Cascaded: This simple 2:1 purchase is attached to a 6:1 cascade for a 12:1 system. Used on larger racing and cruising boats.

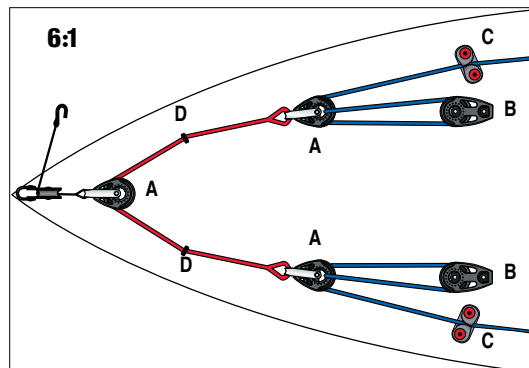

6:1 Double-ended Jib Downhaul: Small boats like J/24s use a double-ended genoa cunningham system to adjust draft from the weather rail.



Mastbase & Cabintop Blocks

Part numbers represent hardware most commonly used.

Typical boat length:

Small Boat: 6.7 - 8.5 m (22 - 28')
 Midrange: 8.8 - 10.4 m (29 - 34')
 Big Boat: 10.7 - 12.8 m (35 - 42')

Diagram Ref.	Description	Small Boat Part No.	Midrange Part No.	Big Boat Part No.
1 Halyard				
A	Mastbase	222	1986	1990
B	Cheek	2644	2606	3220
C	Single	2652	—	—
D	Flip-Flop	2142	3122	1987
3 Halyards				
A	Mastbase	222	1986	1990
B	Deck organizer	9001	9001	9006
C	Winch	20.2PTP	35.2PTP	40.2PTP
D	Single	2636	2660	1540
E	Stand-up spring	097	071	1634
F	Stand-up	2652	3227	3244
6 Halyards				
A	Mastbase	1986	1988	1990
B	Deck organizer	9001	9006	9006
C	Winch	20.2PTP	35.2PTP	40.2PTP
D	Crossover	—	1984	1981
Over the Top				
A	Mastbase	1986	1988	1990
B	Mastbase	1986	1988	1990
C	Mastbase	3002	3002	3002

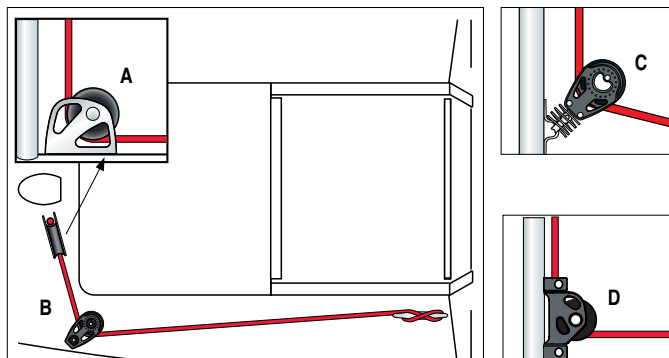

1 Halyard: This simple system leads principle halyards aft. Used by boats under 9 m (30').

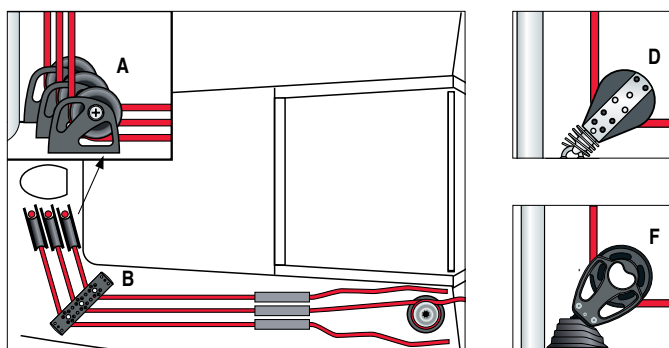

3 Halyards: Larger boats use special mastbase halyard lead blocks. Lines are routed out to deck organizers then aft to stoppers and winches. Stand-up blocks on a base are sometimes preferred for their complete articulation, but they hold halyards higher off the deck than specialized mastbase blocks.

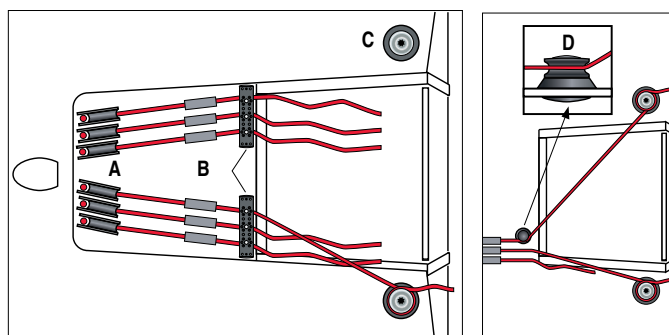

6 Halyards: Modern race boats lead halyards and control lines straight aft through deck organizers so they can be used on either cabintop winch.



Over-the-Top: Special "over-the-top" blocks are required to route lines over an outside corner like the front of a doghouse or coaming.



Spinnaker

Part numbers represent hardware most commonly used.

Typical boat length:

Small Boat: 6.7 - 8.5 m (22 - 28')
 Midrange: 8.8 - 10.4 m (29 - 34')
 Big Boat: 10.7 - 12.8 m (35 - 42')

Diagram Ref.	Description	Small Boat Part No.	Midrange Part No.	Big Boat Part No.
Standard Sheets				
A	Single	2636	2600	—
B	Single	2637	2601	—
C	Bullseye	339	237	—
D	Single	340	2636	—
E	Single	2146	2149	—
F	Cam cleat	468	150	—
G	Single	2625	2660	—
Standard Sheets and Guys				
A	Single	—	2600	2660
B	Single	—	2636	2600
C	Bullseye	—	237	237
D	Stand-up	—	3227	3244
E	Cam cleat	—	150	150
F	Single	—	3226	3231
Asymmetrical on Sprit				
A	Single	2148	2660	3231
B	Bullseye	339	237	237
C	Cam cleat	150	150	280
D	Single	2680	1549/1571	3215
Continuous Line—Beachcat				
	Multihulls	2.4 - 4.3 m (8 - 14')	4.6 - 6 m (15 - 20')	6.4 - 9 m (21 - 30')
A	Single	2625	2625	2680
B	Single	2146	2148	2151

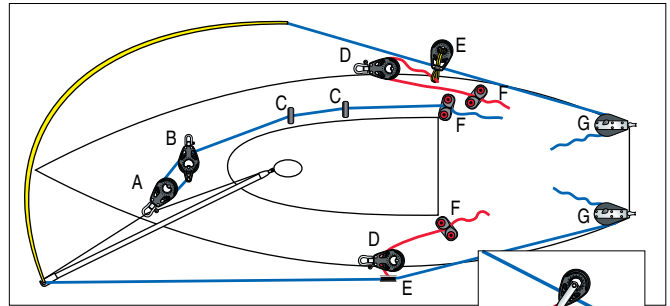

Standard Sheets: Masthead rigs to 8.5 m (28') and fractional rigs to 9.7 m (32') use one pair of lines which lead to turning blocks at the transom. Tweakers bring the guy to the deck near the point of maximum beam to provide additional control over the spinnaker pole. One foreguy line is appropriate for these boats.

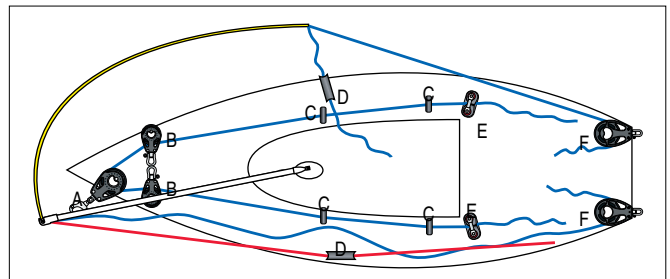

Standard Sheets & Guys: Offshore boats over 9 m (30') use separate sheets and guys. The sheets lead to turning blocks at the transom, while the guys lead to blocks at the point of maximum beam and then to a winch. A double-ended foreguy adjusts from either side of the boat.

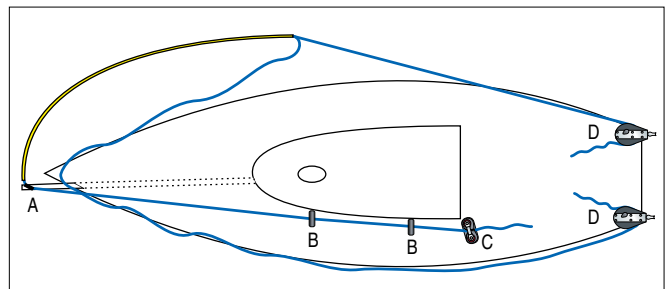

Asymmetrical on Sprit: Boats with asymmetrical spinnakers and retractable (or removable) bowsprits are rigged with a tack line leading through a block on the end of the sprit, and aft to a cleat or stopper. Two sheets attach to the clew of the sail, with the lazy sheet leading aft ahead of the headstay, over the sprit, and outside the shrouds and sheets.

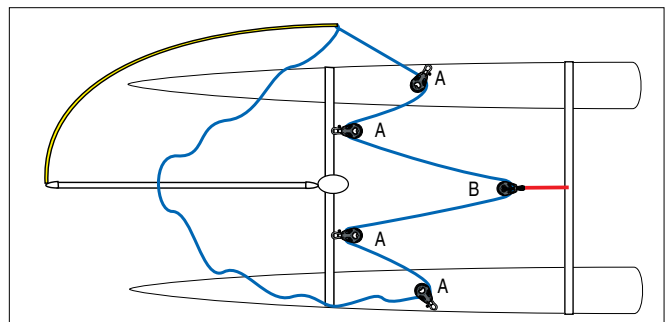

Continuous Line: Beachcats install two Carbo auto ratchets on each side of the boat to manage high spinnaker sheet loads. Use 57 mm ratchets on catamarans up to 6 m (20'). Use 75 mm ratchets on multihulls to 9 m (30').



Spinnaker Pole Handling & Halyards

Part numbers represent hardware most commonly used.

Typical boat length:

Small Boat: 6.7 - 8.5 m (22 - 28')
 Midrange: 8.8 - 10.4 m (29 - 34')
 Big Boat: 10.7 - 12.8 m (35 - 42')

Diagram Ref.	Description	Small Boat Part No.	Midrange Part No.	Big Boat Part No.
2:1 Spinnaker Pole				
A	Spinnaker pole car	3188	3189	3097
B	Single	2146	2148	2148
C	Cam cleat	150	150	150
D	Cheek	350	2644	2644
E	Eyestraps	201	073	137
3:1 Spinnaker Pole				
A	Spinnaker pole car	3188	3189	3097
B	Single	2146	2149	2152
C	Cam cleat	150	150	150
D	Cheek	350	2644	2644
Spinnaker Halyard through Spar				
A	Exit block	089	134	—
B	Cam cleat	150	150	—
Pole Launcher				
A	Single	340	—	—
B	Single w/becket	341	—	—
C	Bullseye	237	—	—
D	Eyestraps	137	—	—

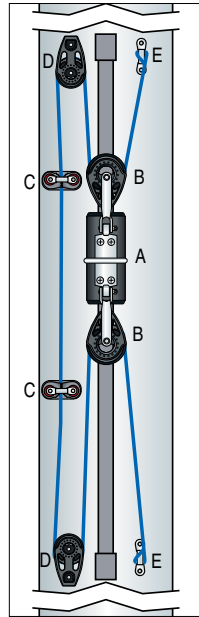

2:1 Spinnaker Pole: This system allows the inboard end of the pole to be moved under load. It features a continuous adjuster line and 2:1 controls.

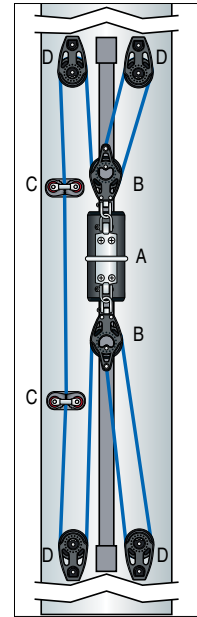

3:1 Spinnaker Pole: This adjustable system features 3:1 controls for more power.

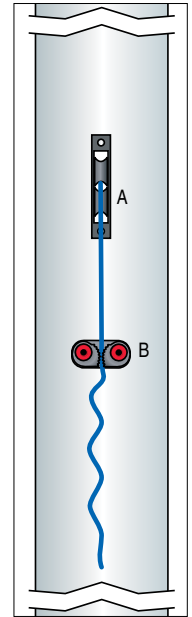

Spinnaker Halyard through Spar: Smaller offshore boats often mount a cam cleat below the spinnaker halyard exit so crew can jump the halyard and cleat it to the mast when setting the spinnaker. The cam also holds the line should the sail fill prematurely.

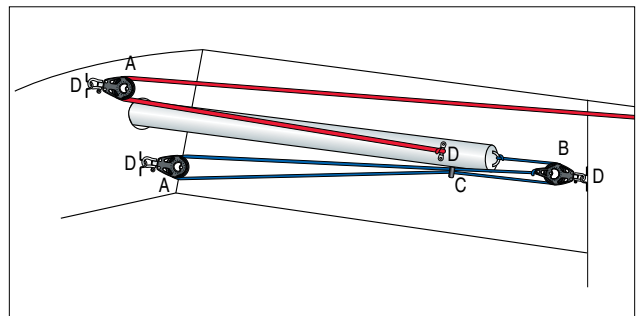

Pole Launcher: Many racing boats have asymmetrical spinnakers and retractable bowsprits. This system features a launcher line on top of the pole, with strong shockchord on the bottom to automatically retract the pole when the launcher line is uncleated.

Backstay Adjuster

Part numbers represent hardware most commonly used.

Typical boat length:

Small Boat: 6.7 - 8.5 m (22 - 28')
 Midrange: 8.8 - 10.4 m (29 - 34')
 Big Boat: 10.7 - 12.8 m (35 - 42')

Diagram Ref.	Description	Small Boat Part No.	Midrange Part No.	Big Boat Part No.
6:1 Right Angle				
A	Triple	2640	—	—
B	Triple	2648	—	—
12:1 Cascaded				
A	Single	300	—	—
B	Triple	344	—	—
C	Triple	347	—	—
4:1 Split Backstay				
A	Single	304	308	—
B	Fiddle	2621	2621	—
C	Fiddle	2624	2624	—
8:1 Split Backstay				
A	Single	304	308	—
B	Fiddle	2655	2621	—
C	Fiddle	2658	2624	—
6:1 Double-ended Split				
A	Single	300	304	—
B	Single	340	2600	—
C	Double	342	2602	—
D	Stand-up	349	2652	—
E	Cheek	350	2644	—
F	Cam cleat	150	150	—
Double-acting Hydraulic Backstay Adjuster				
A	Backstay adjuster	—	HCI025110345BCC.NG HCI035130345BCC.NG	HCI040160385BCC.NG HCI045160385BCC.NG

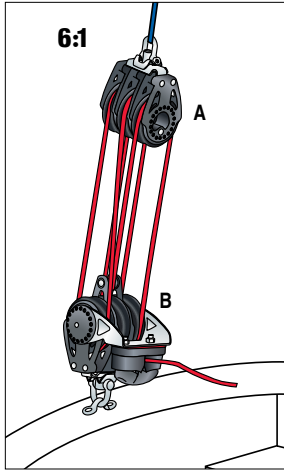

6:1 Right Angle: This simple 6:1 system is used on small cruising boats with a single line or wire backstay.

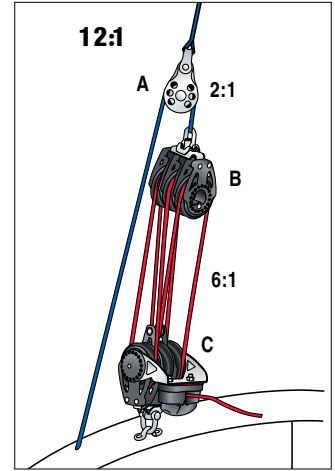

12:1 Cascaded: This cascading 2:1/6:1 system provides a 12:1 purchase and is used on small racer/cruisers and daysailers.

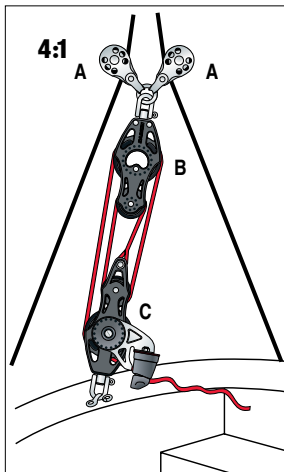

4:1 Split Backstay: This 4:1 system is used on small keelboats with split backstay systems. Pinching the wires together tightens the backstay and increases headstay tension to flatten the genoa, decrease weather helm, and stabilize the rig in heavy air.

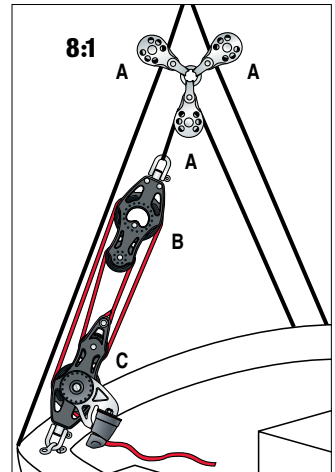

8:1 Split Backstay: A more powerful version of the split backstay adjuster uses a doubling wire running through a wire block for a purchase of 8:1.

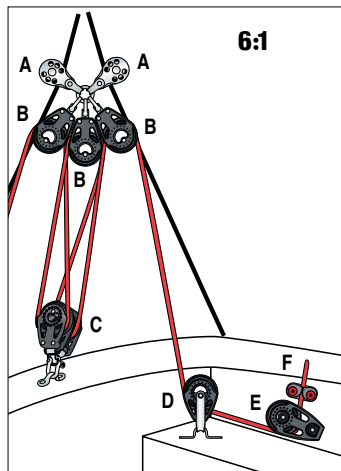

6:1 Double-ended Split: This double-ended split backstay system leads lines forward to cam cleats mounted just ahead of the helmsman so adjustments can be made from either side of the boat.

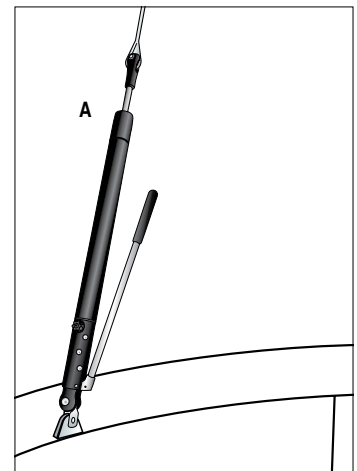

Double-acting Hydraulic Backstay Adjusters: These powerful systems deliver oil when the handle is pushed and pulled, delivering oil twice as fast as single-acting pumps—an excellent choice for racer/cruisers.



Mainsail Reefing

Part numbers represent hardware most commonly used.

Typical boat length:

Small Boat: 6.7 - 8.5 m (22 - 28')

Midrange: 8.8 - 10.4 m (29 - 34')

Big Boat: 10.7 - 12.8 m (35 - 42')

Diagram Ref.	Description	Small Boat Part No.	Midrange Part No.	Big Boat Part No.
Dual Line				
A	Cheek	2644	6237	3220
B	Single	2650	2600	3215
C	Mastbase block	222	1986	1988
D	Bullseye	339	237	237
Lazy Jacks				
A	Lazy Jack kit	252	253	254

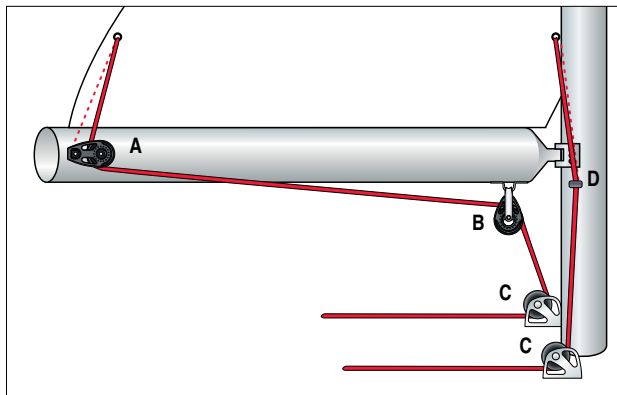

Dual Line: This dual-line system is common on boats 9 m (30') and larger. Position blocks so line pulls down and out to keep the sail flat and prevent lateral loads on the luff rope or luff sliders.

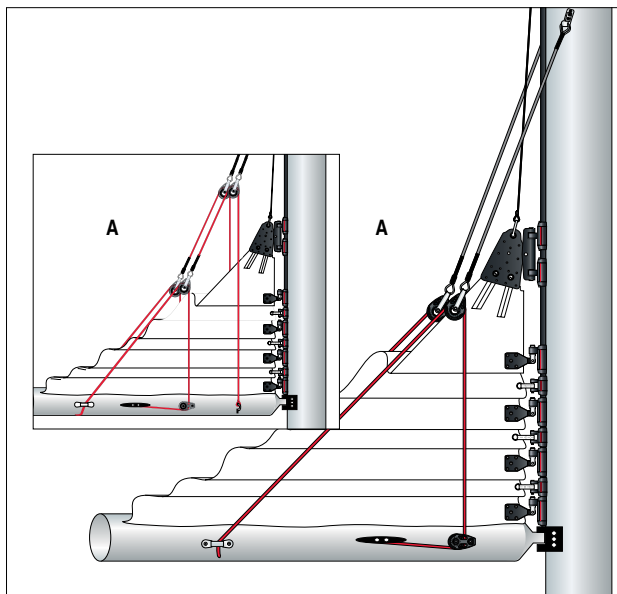

Lazy Jacks: Lazy Jacks contain mainsails during reefing and dousing. They work exceptionally well with full-battened mains, but are also used with conventional sails.



Self-Tacking Jibs & Staysails

Part numbers represent hardware most commonly used.

Typical boat length:

Small Boat: 6.7 - 8.5 m (22 - 28')
 Midrange: 8.8 - 10.4 m (29 - 34')
 Big Boat: 10.7 - 12.8 m (35 - 42')

Diagram Ref.	Description	Small Boat Part No.	Midrange Part No.	Big Boat Part No.
Standard Self-tacker				
A	Through-deck	1200	1202	1203
B	Single	2636	2600	3226/1540
2:1 Self-tacker				
A	Single	—	2660	3226
B	Padeye	1558	688	689
C	Cheek	6237	6267	3220
D	Single	—	2660	3215
Self-tacker on Jib Boom				
A	Furler	Unit 0	Unit 1	Unit 2
B	Double	2602	2662	3217
C	Single	2600	2660	3215
D	Single	2601	2661	3216
E	Deck organizer	9000	9005	9005

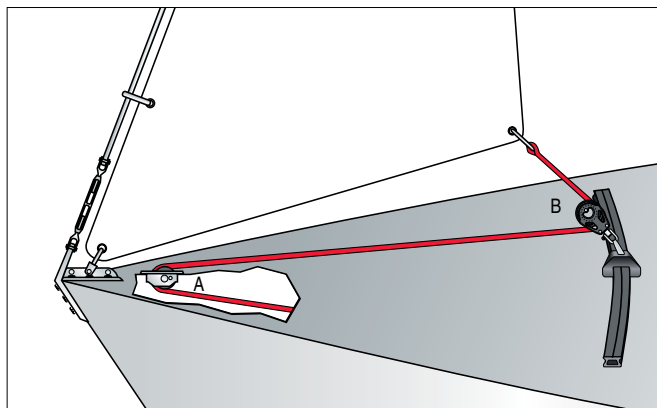

Standard Self-tacker: This system is often used on course racing keelboats like Solings. The traveler track is bent in a radius equal to the distance from the headstay to the sheeting point along the LP of the sail.

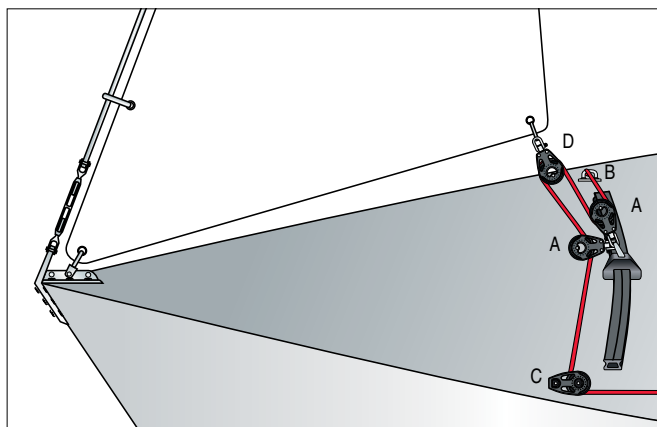

2:1 Self-tacker: Self-tacking jibs are popular because they keep the foredeck clean.

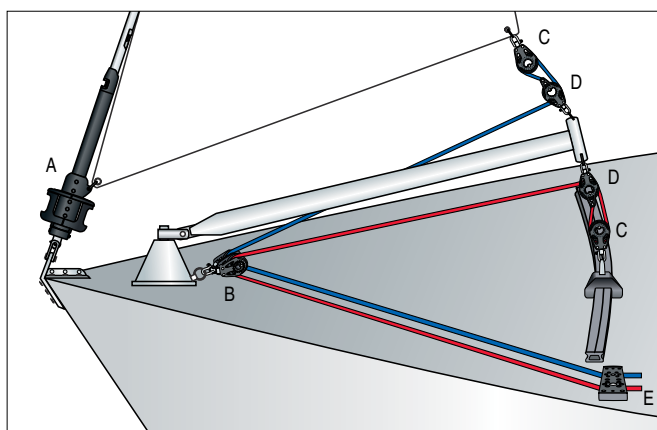

Self-tacker on Jib Boom: Self-tacking jibs and staysails work well with furling systems and jib booms. This system features two "sheets"—one controls the in and out movement of the sail much like an outhaul. The other controls the boom.



Metric Conversions

This catalog shows both imperial and metric measurements. In most cases, the metric dimension shown is calculated from the imperial measurement and rounded to a whole number. For example, 5/16" is generally shown as 8 mm, while an exact conversion would be 7.9375 mm. When referring to a line diameter, it is sufficient to approximate the conversion. In cases where a dimension is critical, exact metric dimensions are shown. For example, a clevis pin for a furling unit with a diameter of 1/2" is shown as 12.7 mm.

Length			Area		
When you know	Multiply by	To find	When you know	Multiply by	To find
Inches	25.40	Millimeters	Square inches	645.2	Square millimeters
Inches	2.540	Centimeters	Square inches	6.452	Square centimeters
Feet	304.80	Millimeters	Square feet	929.0	Square centimeters
Feet	30.48	Centimeters	Square feet	0.0929	Square meters
Feet	0.3048	Meters	Square yards	0.8361	Square meters
When you know	Divide by	To find	When you know	Divide by	To find
Millimeters	25.40	Inches	Square millimeters	645.2	Square inches
Centimeters	2.540	Inches	Square centimeters	6.452	Square inches
Millimeters	304.8	Feet	Square centimeters	929.0	Square feet
Centimeters	30.48	Feet	Square meters	0.0929	Square feet
Meters	0.3048	Feet	Square meters	0.8361	Square yards

Weight		
When you know	Multiply by	To find
Ounces	28.35	Grams
Pounds	0.4535	Kilograms

Liquid		
When you know	Multiply by	To find
Liters	0.26417	Gallons
Liters	2.1134	Pints

To use the online calculator for finding length, area and weight go to www.harken.com

Equivalency Table

Fraction	Decimal	mm
1/32	0.0313	.7938
1/16	0.0625	1.5875
3/32	0.0938	2.3813
1/8	0.125	3.175
5/32	0.1563	3.9688
3/16	0.1875	4.7625
7/32	0.2188	5.5563
1/4	0.25	6.35
9/32	0.2813	7.1438
5/16	0.3125	7.9375
11/32	0.3438	8.7313
3/8	0.375	9.525
13/32	0.4063	10.3188
7/16	0.4375	11.1125
15/32	0.4688	11.9063
1/2	0.5	12.7
17/32	0.5313	13.4938
9/16	0.5625	14.2875
19/32	0.5938	15.0813
5/8	0.625	15.875
21/32	0.6563	16.6688
11/16	0.6875	17.4625
23/32	0.7188	18.2563
3/4	0.75	19.05
25/32	0.7813	19.8438
13/16	0.8125	20.6375
27/32	0.8438	21.4313
7/8	0.875	22.225
29/32	0.9063	23.0188
15/16	0.9375	23.8125
31/32	0.9688	24.6063



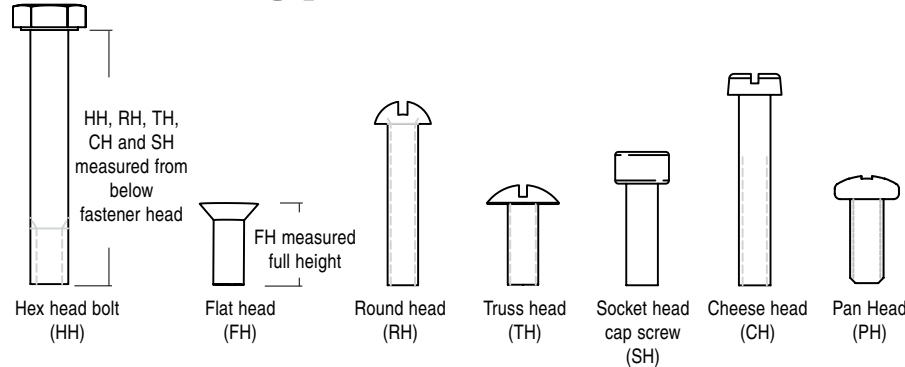

Fastener Types



Drilling Guide

Fastener mm	Drill for clearance hole mm	Drill for tapping mm	Fastener	Drill for clearance hole in	Drill for tapping
	mm	mm		in	
2	2.25	1.6	6-32	9/64	#36
2.5	2.75	2.05	8-32	11/64	#29
3	3.25	2.5	10-24	13/64	#25
4	4.25	3.25	10-32	13/64	#21
5	5.25	4.25	1/4-20	17/64	#7
6	6.25	5	5/16-18	21/64	#F
8	8.25	6.75	3/8-16	25/64	5/16"
10	10.25	8.5	7/16-14	29/64	#T
12	12.25	10.25	1/2-13	33/64	27/64"
16	16.26	14	5/8-11	41/64	17/32"

Ball Bearing Replacement Chart

Car	Bearing style	Part number		Description	Car width in mm Capacity	Car length in mm	# balls per car	Ball material	Ball kit Part No. # Balls	Ball diameter in mm	Car loader Included	Car loader for CB+ to non-CB Order				
		CB+ car	CB-only car													
																
CB only		2700, 2701, 2702, 2703		Micro CB	19/16	40	23/16	56	40	Torlon	2708	20	3/16	5	—	—
CB+		2726, 2728, 2730, 2732, 2744		Small Boat CB	23/16	56	2/78	73	40	Delrin	176	21	1/4	6	—	HSB116
CB+		2727, 2729, 2731, 2733, 2734, 2745		Small Boat CB high-load	23/16	56	2/78	73	40	Torlon	177	21	1/4	6	—	HSB116
CB+		2735, 2736, 2737, 2738, 2746		Small Boat CB 1250 series	23/16	56	4/18	105	60	Torlon	177	21	1/4	6	—	HSB116
Non-CB		156, 157, 171, 211		Small Boat	23/16	56	2/78	73	42	Delrin	176	21	1/4	6	HSB116	—
Non-CB		158, 159, 172, 210, 212		Small Boat high-load	23/16	56	2/78	73	42	Torlon	177	21	1/4	6	HSB116	—
Non-CB		214, 215, 247, 440, 441		Small Boat 1250 series	23/16	56	4/38	111	64	Torlon	177	21	1/4	6	HSB116	—
CB+		T2701B, T2702B, T2703B, T2705B, T2721B, T2722B, T2731B, T2732B, T2741B, T2742B		T27 Midrange CB	23/4	70	4 1/4	108	48	Torlon	1526	25	5/16	8	—	HMR2
CB+		T2701B.HL, T2702B.HL, T2703B.HL, T2705B.HL, T2721B.HL, T2722B.HL, T2731B.HL, T2732B.HL, T2741B.HL, T2742B.HL		T27 Midrange CB high-load	23/4	70	53/16	132	60	Torlon	1526	25	5/16	8	—	HMR2
CB+		T2704B.HL, T2744B.HL		T27 Midrange CB 2 cars with 2 toggles	23/4	70	4 1/4	108	48 x 2	Torlon	1526	25	5/16	8	—	HMR2 x 2
CB+		1635		Midrange CB windward sheeting	23/4	70	4 1/4	108	48	Torlon	1526	25	5/16	8	—	HMR2
CB+		1636		Midrange CB high-load windward sheeting	23/4	70	53/16	132	60	Torlon	1526	25	5/16	8	—	HMR2
CB+		1624, 1628		Midrange CB	23/4	70	4 1/4	108	48	Torlon	1526	25	5/16	8	—	HMR2
CB+		1629		Midrange CB long	23/4	70	53/16	132	60	Torlon	1526	25	5/16	8	—	HMR2
CB only		1626, 1640		Midrange CB	23/4	70	4 1/4	108	48	Torlon	1526	25	5/16	8	—	—
CB only		1625, 1627, 1641		Midrange CB long	23/4	70	53/16	132	60	Torlon	1526	25	5/16	8	—	—
Non-CB		1508, 1575, 1594		Midrange	23/4	70	4 1/4	108	48	Torlon	1526	25	5/16	8	—	—
Non-CB		1509, 1576, 1595		Midrange long	23/4	70	5 1/4	133	60	Torlon	1526	25	5/16	8	HMR2	—
Non-CB		1604		Midrange with 2 toggles	23/4	70	7 1/4	184	86	Torlon	1526	25	5/16	8	HMR47	—
CB+		T3201B, T3202B, T3203B, T3205B, T3221B, T3222B, T3231B, T3232B, T3241B, T3242B		T32 Big Boat CB 3000 series	3 5/16	85	5 3/8	136	50	Torlon	547	25	3/8	10	—	HBB1
CB+		T3201B.HL, T3202B.HL, T3203B.HL, T3205B.HL, T3221B.HL, T3222B.HL, T3231B.HL, T3232B.HL, T3241B.HL, T3242B.HL		T32 Big Boat CB 4500 series	3 5/16	85	7 7/16	188	72	Torlon	547	25	3/8	10	—	HBB28
CB+		T3204B, T3224B, T3234B, T3244B, T3209B		T32 Big Boat CB 5000 series with 2 toggles/shackles	3 5/16	85	9 1/8	231	90	Torlon	547	25	3/8	10	—	HBB25
CB+		T3204B.HL, T3224B.HL, T3234B.HL, T3244B.HL, T3209B.HL		T32 Big Boat CB 2 high-load cars with 2 toggles	3 5/16	85	7 7/16	188	72 x 2	Torlon	547	25	3/8	10	—	HBB28 x 2
CB+		T3208B		T32 Big Boat CB 2 cars with 2 toggles	3 5/16	85	5 3/8	136	50 x 2	Torlon	547	25	3/8	10	—	HBB1 x 2
CB+		3176, 3177		Big Boat CB 3000 series windward sheeting	3 5/16	85	5 3/8	136	50	Torlon	547	25	3/8	10	—	HBB1
CB+		3178, 3179		Big Boat CB 4500 series windward sheeting	3 5/16	85	7 7/16	188	72	Torlon	547	25	3/8	10	—	HBB28
CB+		3160, 3163, 3164		Big Boat CB 3000 series	35/16	85	5 3/8	136	50	Torlon	547	25	3/8	10	—	HBB1
CB+		3161, 3165, 3166		Big Boat CB 4500 series	35/16	85	7 7/16	188	72	Torlon	547	25	3/8	10	—	HBB28

Torlon is a registered trademark of Solvay Advanced Polymers L.L.C.



Delrin is a registered trademark of E. I. du Pont de Nemours and Company or its affiliates.

Car	Bearing style	Part number		Description	Car width		Car length		# balls per car	Ball material	Ball kit Part No.	Ball diameter		Car loader		Car loader for CB+ to non-CB	
		CB+ car	CB-only car		in	mm	in	mm				in	mm	Included	Order		
CB+	1648			Midrange CB	2 3/4	70	5 3/16	132	60	Torlon	1526	25	5/16	8	—	—	HMR2
Non-CB	1615			Midrange	2 3/4	70	5 1/4	133	60	Torlon	1526	25	5/16	8	HMR2	—	—
CB+	3076			Big Boat CB 3000 series	3 5/16	85	5 1/4	133	50	Torlon	547	25	3/8	10	—	—	HBB1
CB+	3096			Big Boat CB 4500 series	3 5/16	85	7 1/4	184	72	Torlon	547	25	3/8	10	—	—	HBB28
Non-CB	595			Big Boat 3000 series	3 5/16	85	5 1/4	133	50	Torlon	547	25	3/8	10	HBB1	—	—
Non-CB	1771			Big Boat 4500 series	3 5/16	85	7 1/4	184	72	Torlon	547	25	3/8	10	HBB28	—	—
CB only	3813			System AA CB headboard	1 9/16	40	2 3/16	132	40 x 2	Torlon	2708	20	3/16	5	—	—	—
CB only	3815			System AA CB intermediate car	1 9/16	40	2 3/16	56	40	Delrin	492	20	3/16	5	—	—	—
CB only	3816			System AA CB Battcar	1 9/16	40	2 3/16	56	40	Torlon	2708	20	3/16	5	—	—	—
CB+	3811			System A CB headboard	2 3/16	56	4 1/8	105	60 x 2	Torlon	177	21	1/4	6	—	—	HSB116 x 2
CB+	3812			System A CB intermediate car	2 3/16	56	2 1/4	57	30	Torlon	177	21	1/4	6	—	—	HSB116
CB+	3829, 3830, 3831, 3881			System A CB Battcar	2 3/16	56	2 7/8	73	40	Torlon	177	21	1/4	6	—	—	HSB116
CB+	3882, 3883			System A CB high-load	2 3/16	56	4 1/8	105	60	Torlon	177	21	1/4	6	—	—	HSB116
Non-CB	1792, 1807			System A headboard car	2 3/16	56	3 5/8	92	52 x 2	Delrin/Torlon*	177	21	1/4	6	HSB116 x 2	—	—
Non-CB	1925, 1901, 1944, 1976, 1977			System A Battcar	2 3/16	56	3	76	40	Delrin/Torlon*	177	21	1/4	6	HSB116	—	—
Non-CB	1894			System A luff car	2 3/16	56	2 1/8	54	30	Delrin/Torlon*	177	21	1/4	6	HSB116	—	—
CB+	3852			System B CB headboard	2 3/4	70	5 3/16	132	60 x 2	Torlon	1526	25	5/16	8	—	—	HMR2 x 2
CB+	3863			System B CB intermediate car	2 3/4	70	2 9/16	68	28	Torlon	1526	25	5/16	8	—	—	HMR2
CB+	3856, 3857, 3859, 3879			System B CB Battcar	2 3/4	70	4 5/16	109	48	Torlon	1526	25	5/16	8	—	—	HMR2
CB+	3860			System B CB reef car	2 3/4	70	5 3/16	132	60	Torlon	1526	25	5/16	8	—	—	HMR2
Non-CB	1793			System B headboard car	2 3/4	70	4 3/8	111	48 x 2	Delrin/Torlon*	1526	25	5/16	8	HMR2 x 2	—	—
Non-CB	1979			System B intermediate car	2 3/4	70	3 13/16	97	40	Delrin/Torlon*	1526	25	5/16	8	HMR2	—	—
Non-CB	1794, 1826, 1902, 1946, 1978, 1980			System B Battcar	2 3/4	70	3 13/16	97	40	Delrin/Torlon*	1526	25	5/16	8	HMR2	—	—
Non-CB	1895			System B luff car	2 3/4	70	2 3/4	70	30	Delrin/Torlon*	1526	25	5/16	8	HMR2	—	—
CB+	3867			System C CB headboard	3 5/16	85	9 1/8	232	90 x 2	Torlon	547	25	3/8	10	—	—	HBB25 x 2
CB+	3871			System C CB intermediate car	3 5/16	85	3 3/4	96	34	Torlon	547	25	3/8	10	—	—	HBB1
CB+	3868, 3869, 3870, 3872			System C CB Battcar	3 5/16	85	5 3/8	136	50	Torlon	547	25	3/8	10	—	—	HBB1
CB+	3873			System C CB reef car	3 5/16	85	9 1/8	231	90	Torlon	547	25	3/8	10	—	—	HBB25
Non-CB	1782			System C headboard car	3 5/16	85	5 1/2	140	52 x 2	Torlon	547	25	3/8	10	HBB1 x 2	—	—
Non-CB	1784, 1795, 1827, 1828, 1829, 1903			System C Battcar	3 5/16	85	4 3/4	121	44	Torlon	547	25	3/8	10	HBB1	—	—
Non-CB	1785			System C luff car	3 5/16	85	4	102	36	Torlon	547	25	3/8	10	HBB1	—	—
Non-CB	1785HL			System C high-load luff car	3 5/16	85	4	102	36	Torlon	547	25	3/8	10	HBB1	—	—

OUTHAUL

BATTICAR

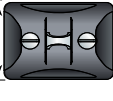
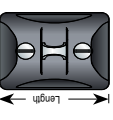
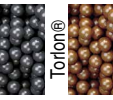

*Torlon bearings used on all high-load "HL" cars. Delrin is a registered trademark of E. I. du Pont de Nemours and Company or its affiliates. Torlon is a registered trademark of Solvay Advanced Polymers L.L.C.



Typical Rigging Breaking Loads†

Type 316 1 x 19 (25) Compacted Strand, example Dyform® wire rigging				Type 316 1 x 19* Stainless Wire Rope				Nitronic® 50 Stainless Rod Rigging, example Navtec®				Dacron® Double Braid Rope				Vectran® Core Rope w/Dacron Cover†				
Breaking load		Size		Breaking load		Size		Breaking load		Size		Breaking load		Size		Breaking load		Size		
lb	kg	mm	in	lb	kg	mm	in	lb	kg	mm	in	lb	kg	mm	in	lb	kg	mm	in	
4928	2235	5	5/8	3960	1800	3/8	14500	6580	-4	0.172	4.37	4700	2130	1/4	1800	815	6	1800	815	
8844	4011	6	7/8	5445	2470	1/2	25680	11650	-6	0.198	5.03	6300	2860	5/16	2800	1270	7	2800	1270	
10802	4899	7	1 1/8	7090	3220	—	—	—	-8	0.225	5.72	8200	3720	3/8	3750	1700	9	3750	1700	
13530	6136	8	1 1/2	Type 302 1 X 19* Stainless Wire Rope				-10	0.250	6.35	10300	4670	7/16	5500	2490	11	5500	2490		
19272	8740	10	1 5/8	500	227	9/32	10300	4671	-12	0.281	7.14	12500	5670	1/2	7000	3175	12	7000	3175	
26620	12072	11	1 3/4	1200	544	5/16	12500	5669	-15	0.296	7.52	14250	6480	9/16	10000	4535	14	10000	4535	
34833	15797	14	1 7/8	2100	952	3/8	17500	7936	-17	0.33	8.38	17500	7940	5/8	14000	6350	15	14000	6350	
42460	19256	16	1 5/8	3300	1497	7/16	23400	10612	-22	0.375	9.53	22500	10200	3/4	16000	7250	19	16000	7250	
56320	25541	19	2	4700	2131	1/2	29700	13469	-30	0.437	11.1	30000	13600	7/8	25000	11340	22	25000	11340	
70400	31926	—	—	6300	2857	9/16	36500	16553	-40	0.500	12.7	38000	17200	100% Spectra®/Dyneema® Core Rope w/Dacron Cover						
Type 316 1 x 19** Stainless Wire Rope				7/32	8200	3719	5/8	44000	19954	-48	0.562	14.27	48000	21800	Size	Breaking load	Size	Breaking load	Size	Breaking load
706	320	9	1 1/4	8200	3719	5/8	44000	19954	-60	0.660	16.76	60000	27200	in	lb	kg	in	lb	kg	
2	907	10	1 1/2	8200	3719	5/8	44000	19954	-76	0.705	17.91	76000	34500	1/4	5100	2313	1/4	5100	2313	
1103	500	9.53	14509	2830	1285	3	1120	510	-91	0.768	19.51	90000	40800	5/16	6200	2812	5/16	6200	2812	
1588	720	10	15987	3865	1750	4	2130	970	-115	0.875	22.23	115000	52200	3/8	9800	4444	3/8	9800	4444	
2822	1280	11	19338	5040	2280	5	3130	1420	-150	1.000	25.40	150000	68000	7/16	14000	6349	7/16	14000	6349	
3969	1800	12	22933	11350	5150	6 (-8)	4490	2040	-170	1.066	27.08	170000	77100	1/2	21000	9524	1/2	21000	9524	
4410	2000	12.7	25689	20165	9140	7 (-12)	6120	2780	-195	1.125	28.58	190000	86200	100% Spectra®/Dyneema® Core Rope w/Dacron Cover						
5447	2470	14	31268	20165	9140	7 (-12)	6120	2780	-220	1.191	30.25	217000	98400	Size	Breaking load	Size	Breaking load	Size	Breaking load	
6351	2880	16	40926	8000	3630	8	8000	3630	-260	1.313	33.35	260000	118000	in	lb	kg	in	lb	kg	
7100	3220	19	47674	8000	3630	8	8000	3630	-320	1.500	38.10	320000	145000	1/4	5800	2630	1/4	5800	2630	
7828	3550	22	64101	8000	3630	8	8000	3630	—	—	—	—	—	3/8	9800	4443	3/8	9800	4443	
10232	4640	26	89526	8000	3630	8	8000	3630	—	—	—	—	—	5/16	13300	6032	5/16	13300	6032	
—	—	—	—	8000	3630	8	8000	3630	—	—	—	—	—	3/8	19000	8617	3/8	19000	8617	
—	—	—	—	—	—	—	—	—	—	—	—	—	—	—	—	—	—	—	—	—

*Typical American wire. **Typical European wire. †Breaking load may vary widely by manufacturer.

Dacron is a registered trademark of E. I. du Pont de Nemours and Company or its affiliates.

Dyform is a registered trademark of Bridon International Ltd.

Dyneema is a registered trademark of DSM IP Assens B.V. L.L.C.

Navtec is a registered trademark of Lewmar, Ltd.

Nitronic is a registered trademark of AK Steel Corporation.

Spectra is a registered trademark of Honeywell International, Inc.

Vectran is a registered trademark of Kuraray Co., Ltd.

Loading Formulas

Block Loading vs Angle of Deflection

Load on a block is a combination of the load on the line passing through the block, plus a block-loading factor, which is determined by the angle by which the block turns the sheet. For example, a footblock that turns a sheet 180 degrees will see a load equal to twice the load on the sheet. A deck organizer, which turns a halyard only 30 degrees, will see just 52 percent of the load on the halyard.

Boat Type

Most load formulas assume a medium displacement monohull, but you can easily correct for other boat types. Multihulls and boats with canting keels or water ballast have great form stability and speed and will often carry sails very high in the apparent wind speed, so calculations must be done with this wind speed in mind. ULDBs are typically tender and often change sails or reef quite early, so loading may be done at relatively low wind speeds. For example, a modern trimaran may carry its blade jib in 25 knots of wind at speeds over 15 knots for an apparent wind of nearly 40 knots, whereas a ULDB will probably remove its #1 genoa at about 15 knots of apparent wind.

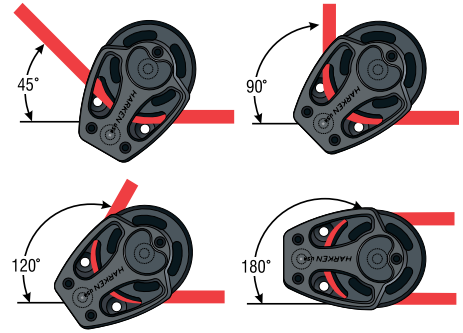

Angle of deflection	Load factor	Angle of deflection	Load factor	Angle of deflection	Load factor
30°	52%	90°	141%	150°	193%
45°	76%	105°	159%	160°	197%
60°	100%	120°	173%	180°	200%
75°	122%	135°	185%		

Genoa System Loading

Because wind speed is squared, it is the most important variable and can greatly influence loading. Wind speed (the apparent wind) should be calculated for the specific sail being analyzed. For example, the #1 genoa on a 7 m (25') boat might only be carried in 15 knots of wind, while the #3 blade on a Maxi-boat could well be carried in 40 knots.

To calculate loading on a genoa lead car, multiply sheet load by the load factor of the sheet. Most #1 genoas will deflect about 45 degrees, while a #3 genoa may deflect 75 degrees or more.

Lead car adjuster tackle load is dependent on the angle of deflection of the sheet in the lead car, but is generally assumed to be 0.3 of lead car load when deflection is 45 degrees and .05 of lead car load when deflection is 60 degrees.

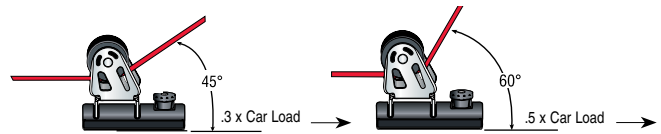

GENOA SHEET LOAD

English		Metric	
$SL = SA \times V^2 \times 0.00431$		$SL = SA \times V^2 \times 0.02104$	
SL	Sheet load in pounds	SL	Sheet load in kilograms
SA	Sail area in square feet	SA	Sail area in square meters
V	Wind speed in knots	V	Wind speed in knots

Formulas are for typical cruising monohulls with fixed keel and Dacron® sails, sheets, and halyards. For all other types, please contact Harken for technical assistance in calculating loads.

Mainsheet System Loading

The formula for mainsheet loading is not as widely accepted as that for genoa sheet loads and should only be used as a rough guide for offshore boats from 9 - 18 m (30 - 60').

Traveler car adjuster load is generally considered to be 0.2 times car load.

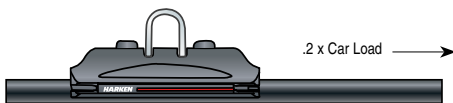

MAINSHEET LOAD

English		Metric	
$ML = \frac{E^2 \times P^2 \times 0.00431 \times V^2}{(\sqrt{P^2 + E^2}) \times (E - X)}$		$ML = \frac{E^2 \times P^2 \times 0.02104 \times V^2}{(\sqrt{P^2 + E^2}) \times (E - X)}$	
ML	Mainsheet load in pounds	ML	Mainsheet load in kilograms
E	Foot length of main in feet	E	Foot length of main in meters
P	Luff length of main in feet	P	Luff length of main in meters
V	Wind speed in knots	V	Wind speed in knots
X	Distance from aft end of boom to mainsheet attachment point in feet	X	Distance from aft end of boom to mainsheet attachment point in meters

Formulas are for typical cruising monohulls with fixed keel and Dacron sails, sheets, and halyards. Assumes standard roach of 7.5%. For large roach sails such as "flattops" multiply calculated load by the percentage of the mainsail roach. If a sail has 25% roach, multiply the calculated load by 1.25. For all other types, please contact Harken for technical assistance in calculating loads.

Rig Dimensions

The following abbreviations are often used to describe various measurements on a sailboat. Precise technical definitions exist for each abbreviation, but the following is a list of simple descriptions:

LOA	Length overall - overall tip-to-tip length of the boat	I₂	Height of staysail halyard above deck
LWL	Length waterline - length of waterline of the boat	J	Base of the foretriangle measured from the front of the mast to the intersection of the forestay and deck
DWL	Design waterline - theoretical waterline length of boat as opposed to LWL, which is actual waterline length	J₂	Base of staysail triangle
BMX	Beam maximum - width of the boat at the widest point	P	Luff length of the mainsail
BWL	Beam waterline - widest beam of boat at the waterline	E	Foot length of the mainsail
I	Height of the foretriangle measured from the top of the highest sheave to the sheerline	LP	Shortest distance from headstay to the clew of the jib

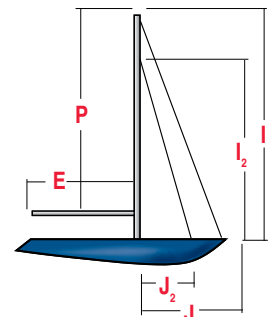

Index

All blocks (see "BLOCKS")
All cars (see "TRAVELERS")
All winches (see "WINCHES")

A

Accessories 71-72, 75, 102, 104, 107, 109,
..... 111, 115, 117, 119, 157, 191, 222-224, 249
Access Rail 128-129
Addresses 290-291
Athwartship Systems, Custom 125-126

B

Backstay Adjuster, Hydraulic 234
Backstay Systems Drawings 271
Ball Bearing Replacement Chart 275-277
Ball Bearing Winch Handles 223
Bases
Ball and Socket 74
Cam 73
Custom Removable Padeyes 92
Eyestraps 86
Padeyes 90
Stand-Up 74
Swivel 77-78

Batten Traveler Systems 134-152
Battcars 134-152
Bearings, Replacement 275-277
Below-Deck Furling 163
Bends, Track 127
Big Boat Travelers 115-119, 122, 125-126
Block Covers 57
Block Socks 57
Bolt-Down Fairleads 92
Boom Vangs, Hydraulic 240-241
Breaking Strengths, Rigging 278
Bullseye Fairleads 73, 75

BLOCKS

16 mm 33
Air Blocks 18-29, 50-58
Air Runners 57
Anti-Capsize 33-34
Backstay, Runners 57
Big Boat 43-64
Black Magic Air Blocks 50-58
Carbon Fiber 64-65
Custom 61, 63
Element 46-49
FlatWinder 59
Flip-Flop 63
Footblock 49-51, 61-63
Loop 53-57, 64-66
Low-Load 52-54
Mastbase 60-63
Megayacht 61, 66
Over-the-Top 63
Powered 61
Runner 57
Snatch 66
Spriddle 54
Stainless Steel 60-61
Stand-Up 47-49, 52-56, 61
Swivel 47-49, 52-56, 60-61
Teardrop 58, 60-61
V 64-65
Big Bullet 36-37
Bullet 36
Carbo Air Blocks 18-30

29 mm 18-19
40 mm 18, 21-22, 26-27, 30
57 mm 19, 23, 25-30
75 mm 24-30
Clew Block Assembly 20
Fiddle 30
Fixed Head 20-21
HTE Ratchamatic 25
Loop 19
Quad 21-23
Power3 Ratchet 25
Ratchamatic 19, 28-29
Ratchet 26-27, 30
T2 Soft Attach 19

Carbon Fiber 64-65
Classic 35-41
Midrange 41-42
Small Boat 33-38
Wire 42

Cheek

Big Boat 47-49, 58-60
Carbo 20-22, 23-24, 26-29
Classic 35-36, 36, 41-42
Element 47-49
ESP 60
Ratchet 26, 28

Clew Block Assembly 20
Crossover 57

Cruising ESP 60, 76
Sheaves 76
Stainless Steel 60

Dinghy 37
Doubles 19-20, 21-24, 29, 33-34,
..... 36-37, 39, 41, 47-49, 53-54, 58, 63
Electric Footblock 59
Element 46-49
Exit Blocks 32-34, 37-38, 42

Fiddles

Big Boat 44-45, 54, 60
Carbo 30
Classic 34, 41
Element 47-49
Midrange Classic 41
Small Boat Classic 34

Fine-Tune Systems 262-264
Fixed-Head 20-22, 34-35, 36
Fixed-Lead 36, 191
FlatWinder 59
Flip-Flop 28, 60
Fly Blocks 16

Footblocks

Black Magic 50
Electric 59
Element 47-49
Lock-Off 48-49, 58, 60
Stainless Steel 60-61

Forkhead

16 mm 32
Micro 34
Grand Prix 64-65
Gross-Trim/Fine-Tune Systems 262-264
Halyard Lead 58, 60-63
Hexa-Cat Bases 38
Hexaratchets 19, 25-31, 38, 41
Hook-In Halyard 33
HTE Ratchamatic 25

Lockoff Blocks

Black Magic Footblocks 58

Element Footblocks 48-49
Loop 16, 19, 53-56, 64-66
Low-load Black Magic Air Blocks 53-54
Megayacht 61
Mastbase Lead 58, 60-62
Mastcollar 58, 60-61
Micro 34
Midrange 40-41
Optimist Halyard 33
Over-the-Top 63
Padeye Blocks 60
Pivoting Lead Block 20, 21-22
Power3 Ratchets 25
Protexit Blocks 32
Quadruples 22-24
Radial Vang 102

Ratchets

40 mm Carbo 19, 26-27
57 mm Carbo 19, 25-30
75 mm Carbo 25-26, 28-30
Cheek 26, 28
Doubles 28
Fiddles 30
Flip-Flop 31
Hexa-Cat Bases 38
Little Hexa-Cat Bases 38
Midrange Hexaratchet 41
Ratchamatic 19, 25, 28-29, 31
Soft-Attach 19
T2 19
Triples 26, 28, 41

Running Backstay

Air Runners 57
Covers 57

Small Boat 19-38, 42

16 mm 33
Carbo Air Blocks 18-30
Cheek 20-21, 23, 26, 28, 33-34, 36, 42
Classic 35-38, 42
Deck Organizers 80
Exit 32-34, 37-38, 42
Fiddle 30, 34
Fly 16
HTE Ratchamatic 25
Micro 34
Pivoting Lead Block 20, 22
Power3 Ratchet 25
Protexit 32
Ratchet 25-27, 38
Soft-Attach 16, 18
Swivel 21-31, 34-35, 37, 39
Through-Deck 33-35, 38-39, 43
Traveler 21, 22
Upright Lead 35, 38-39
V-Jam 35
Wire 37-38, 43

Snatch 68

Soft Attach 16, 20, 54-57, 66, 83

Black Magic 54-60
Carbo 20
Fly 16
High-load Snatch 68
Ratchamatic 23
V 64-65
Spriddle 55

Stainless Steel

16 mm 34

Index

Big Boat	62-63
Cruising ESP	60
Micro	34
Stand-Up	61
Wire	42, 102
Stand-Up	20-21, 47-49, 53-56, 61
Swivel	20-30, 33-34, 36, 38, 41, 47-49, 53-56, 60-61
T2 Soft-Attach	19
Ratchets	19
Singles	22
Teardrop	58, 60-61
Through-Deck	34-36, 37-38, 42
Traveler	19-21, 34
Triples	20, 21-24, 27, 29, 33-34, 36, 41, 47-49, 53
Triples with Ratchets & Cams	
Carbo	27, 29
Midrange	41
Trunnion Snatch Blocks	66
Turning Blocks	58
Two-Speed Mainsheets	262
Upright Leads	34, 36-38
V Block	64-65
V-Jam	34
Vang Block, Radial Traveler	105
Wire	42, 105
Wire Bullets	36-37
C	
Cam Cleat Adapter Plate	71-72
Cam Cleats	68-70
Aluminum	68-70
Carbo	68-70
Stainless Steel	68-70
Carbo Blocks (see "BLOCKS")	
Carbo OneTouch Locking Winch Handle	222
Carbo Racing Foil	160
Carbon Winches (see "WINCHES")	
Car Controls	104, 109, 115-116
Cars (see "TRAVELERS")	
Chafe Guard, Carbo Racing Foil	160
Circuit Breakers	206
Complementary Hardware	67-93
Control Blocks, Traveler	101, 110, 117
Control Boxes, Electric Winch	206
Couplers	105, 117
Curved Track	125
Custom Products	61, 63, 90, 93, 119, 121-124, 127, 142-149
Cylinders, Hydraulic	234-238, 240-242
D	
Deck Organizers	
Big Boat	60, 81
Cruising ESP	60
Midrange	80
Small Boat	80
Stainless Steel	60
Digital System Switch	207
Dinghy	
Blocks	16-38
Clew Hook	75
Jib Leads	95
Distributors	294-295
DN Adapter	74
Drilling Guide	274

E	
Electric Winches	195, 199-201, 203, 204, 208-213
End Controls, Self-Tacking Jibs	109
End Controls, Traveler	104, 109, 115-116
Endstops	100, 102, 107, 113, 121-122, 126, 128-129
Extreme Angle Fairlead	70-72
Eyestraps	71-72, 86
F	
Fairleads	70-72, 75, 86, 92
Fast Release Fairleads	70-72
Filters, Hydraulic	249
Fine-Tune Systems	262-264
Flairleads	73-74
Foil, Carbo Racing	160
Folding Padeyes	87
Formulas, Load	279
Furling	159-191
Block, Stanchion Mount	74, 185, 191
Gennaker	163, 166-170
Hydraulic	186-190
Lead Block Kits	185
MKIV Jib Reefing & Furling	184, 186-190
Powered Furling	182-190
Reflex Free Flying Asymmetric	164-167, 169
Reflex Free Flying Code Zero	168-170
Small Boat	161-163
Small Boat Underdeck	161
Snap Shackles	191
Staysail	163
Systems	
Unit 0 (MKIV)	176
Unit 0 (MKIV Underdeck)	182
Unit 1 (MKIV)	176
Unit 1 (MKIV Underdeck)	182
Unit 1 (Reflex Asymmetric)	167
Unit 1 (Reflex Code Zero)	170
Unit 2 (MKIV)	179
Unit 2 (MKIV Underdeck)	183
Unit 2 (Reflex Asymmetric)	167
Unit 2 (Reflex Code Zero)	168
Unit 3 (MKIV)	179
Unit 3 (MKIV Underdeck)	181
Unit 3 (Reflex)	169
Unit 4 (MKIV)	179
Underdeck	161, 180-183
G	
Gennaker Furling	163-167, 169
Genoa Lead Cars (see "TRAVELERS")	
Grand Prix Jib Fairleads	92
Grease, Winch	224
Gross-Trim/Fine-Tune Systems	262-264
H	
Halyard Restrainers	191
Halyard Sheaves	79
Halyard Tensioner	93
Hand Hold	75
Handles, Winch	222-223
Hose Assemblies, Hydraulic	250
Hydraulic Furling	186-190
Hydraulic Power Units	252
Hydraulic Winches	195, 199, 203, 205, 210-212
Hydraulics	233-252
Accessories	249-250

Backstay Adjuster, Integral	234
Boom Vangs	240-241
Cylinders	234-238, 240-242
Cylinder Rod End Blocks	239
Double-Pull Cylinders	238
Filters	249
Grand Prix Cylinders	242
Hose Assemblies	250
Locking Cylinders	237
Manifolds	243
Oil	249
Power Units	252
Pressure Transducers	249
Pumps	247-248
Reservoirs	248
Through-Deck Gland	250
Valves	243-244
Valve Panels	244-246
Vang Cylinders	237-241
J	
Jib Leads	95, 106, 1011-112, 119, 121-122, 127
Jib Reefing and Furling Systems (see "FURLING")	
K	
Kits	
Cam Fairlead	70-72
Cam Wedges	71-72
Furling Lead Block	185
Lazy Jacks	153
Sail Chafe Protectors	75
Small Boat Furling Components	161-163
Traveler	105, 110, 117
Winch Service	224
L	
Lazy Jacks	153
Lead Rings	91
Line-Shedding Endstop	100, 102
Loading Formulas	279
Soft-Attachments	83
Luff Slider Car	134, 136, 138
M	
Mainsail, Luff Cars	134, 136, 138, 140, 144, 146, 148
Mainsail Outhaul Car	153
Mainsail Reefing Systems	272
Mainsheet Systems Drawings	262-264
Maintenance	258
Manifolds, Hydraulic	243-244
Mastbase Blocks	58, 60-62
Masthead Sheaves	76, 79
Metric Conversions	274
Micro Cam	68-70
Micro Cam X-Treme Angle Fairlead	70-72
Micro Carbo-Cam Base w/Bullseye	73
O	
Oil, Hydraulic	249
Outhaul Systems Drawings	266
P	
Padeyes	87, 90
Pinstops	95, 104, 106, 109, 111-112, 115-116, 119, 121-122, 127-129

Index

Pinstop Track95, 102, 107,
..... 113, 121-122, 126, 128-129
Power Units, Hydraulic 252
Powered Furling 186-190
Prefeeder 75, 160, 191
Pressure Transducers, Hydraulic 249
Pumps, Hydraulic 247

R

Racing Winches (see "WINCHES")
Ratchet Blocks (see "BLOCKS")
Reefing and Furling Systems 172-191
Reference Pages 253-279
Reflex Furling 164-170
Reservoirs, Hydraulic 248
Rigging Breaking Loads 278
Rings, Lead 91
Riser, Cam 71-72
Riser, Traveler Track 107, 113
Rondo, Sail Chafe Protector 75

S

Safety Information 256
Sail Chafe Protectors 75

Selection/Ordering Information

Asymmetric Reflex Furling 166
Battcar Systems 151-152
Big Boat Blocks 44-45
Code Zero Reflex Furling 168
Hydraulics 237, 244, 251
Jib Reefing & Furling 172
Midrange Classic Blocks 40
Travelers 96-97
Winches 232
Self-Tacking Jib Controls 109
Self-Tacking Jib Systems 273

Shackles

Bow 84-85
Captive Halyard 84-85
D Forged 84-85
D High-Resistance 84-85
Large Open 84-85
Soft-Attachments 83
Shallow Bow 84-85
Snap 84-85, 191
Spectra®/Dyneema® Braid 83
Stainless Steel 84-85
Stamped 84-85
Twist 84-85
U-Adaptor 84-85

Sheaves

Big Boat 77
Cruising ESP 77
Halyard 77, 79
High-Load 78, 79
Midrange 76
Self-Contained 76
Small Boat 76
Steering 79
V 78

Slider Battcars 131-134, 136, 138,
..... 142-144, 146, 148, 150-152
Slider Rods, Genoa Car 121
Small Boat Blocks (see "BLOCKS")
Snap Shackles 84-85, 192
Snatch Blocks 66
SnubbAir 193
Soft Shackles 83

Spinnaker Pole Cars 82
Split Backstay Plates 161
Springs 74
Stainless Steel Shackles 84-85
Stanchion Mount Base 74, 185

Stand-Up

Bases 74
Blocks 20, 21, 47-49, 52-56, 63
Springs 74
Toggles 105, 110, 113
Staysail Furling 163-170
Steering Sheaves 79
Stops, Adjustable Pin 95, 104, 106,
..... 109, 115-116, 121-122
Switches, Electric/Hydraulic Winch 206-207

Systems Drawings

Backstay 271
Cunningham 267
Genoa Lead Car 259
Gross-Trim/Fine-Tune 262-264
Halyard 270
Mainsail Reefing 272
Mainsheet 262-263
Mainsheet 2 Speed 264
Mastbase Lead Block 268
Outhaul 266
Self-Tacking Jib 273
Spinnaker 269-270
Traveler 260-261
Vang 265

T

T-Track

Battcar Switch System 142-150
Cars 127, 144, 146, 148, 152
Track 126, 145, 147, 149
Trysail Switch System 150
Tangs, Split Backstay 161
Tiller Extensions 93

Track

Battcar 132-133, 134, 137,
..... 139, 142-143, 145, 147, 149
Bends 125
Endstops 100, 102, 107, 109, 111,
..... 113, 115-116, 121-122, 128-129, 135, 137,
..... 130, 147, 145, 147, 149, 151
High-Beam 94, 96, 100, 102, 107, 113
Low-Beam 100, 102, 107, 113,
..... 121-124, 128-129
Pinstop 93, 95, 98, 102, 107, 113,
..... 111-112, 119, 121, 122, 127, 129-130
Retrofit 102, 107, 113
Risers 107, 113
T-Track 142-149
Traveler 94-125
Track Bends 125
Traveler Stand-Up Toggles 103, 105, 108,
..... 110, 114, 117-118
Traveler Systems Drawings 105, 110, 118, 260-261
Trysail Switch System 150

TRAVELERS

13 mm Micro 100-101
Cars 101
Controls 101
Track 100
22 mm Small Boat 102-106, 120
Cars 103, 120

Controls 116
Track 102

27 mm Midrange 107-112, 120

Cars 108, 120
Controls 109
Track 107

32 mm Big Boat 113-120, 123-124

Cars 114, 119-120, 123-124
Controls 115-118
Custom 119, 123-124
Track 113, 123

42 mm Mini-Maxi 121, 123-124

Cars 121, 123-124
Controls 121
Custom 121, 123-124
Track 121, 123

64 mm Maxi 124

Cars 124
Controls 124
Custom 124
Track 124

Access Rail 125-129

Battcars 131-152

CB (Captive Ball) 82, 94, 101, 103, 105, 108, 111-112, 114, 119-120, 128-129

13 mm Micro 101
22 mm Small Boat 103, 120
27 mm Midrange 108, 120
32 mm Big Boat 114, 120
Genoa Leads 106, 111-112, 119
Outhaul 153
Spinnaker Pole Cars 82
Windward Sheeting 120

CRX (Captive Roller) 123-124

Custom 121-124

Dual Sheave Catamaran Cars 103

Furling Mainsail Outhaul 153

Genoa Leads 106, 111-112, 119, 121-122, 127

Adjustable 106, 111-112, 119
CB (Captive Ball) 106, 111-112, 119
Custom 119, 121-122, 127
Pinstop 106, 111-112, 119, 121-122
Systems Drawings 259
T-Track 126
Track Slides 127

Kits 105, 110, 117

Loop Cars 101, 103, 108, 114, 123-124

Mainsheet 101, 103, 108, 114, 123-124

Radial Vang 103, 105

Replacement Kits 105, 110, 117

Riser, Traveler Track 107, 113

Roller (CRX) 123-124

Cars 123-124
Custom 123-124
Track 124

Self-Tacking Jib Controls 273

Soft-Attachment Cars 101, 103, 108,
..... 114, 123-124

Spinnaker 82

Track 94, 96, 100, 102,
..... 107-108, 113, 121-124, 127-129

Vang Car 103, 105

Windward Sheeting 120

U

U-Adaptors 84-85

Underdeck Furling 161, 180-183

Use Charts ... 40, 44-45, 96-97, 151, 166, 172, 232, 251

Index

V

V Sheaves	78
Valves, Hydraulic	243-244
Vang, Hydraulic	240-241
Vang System Drawings	154-156
Vang Traveler Car	103, 105

W

Warranty	255
Wedges, Cam	72-73
Wire Sheaves	76, 79

WINCHES

Air Winches	218-219
Captive Reel Winches	225-230
Carbon Winches.....214-217	
Air winches	218-19
Grand Prix.....	214-217
Pedestals/Accessories	220-221
Self-Tailing	218-219
Top-Cleating.....	213-215,215-217
Wide-Body	214-218
CLR Mooring Winches	208-209
Digital System Switch.....	207
Drive Components, Pedestal.....	221
Dual-Function Control Box	206
Electric/Hydraulic Components	206-207
Grand Prix	214-217
Handles	222-223
Carbo OneTouch Locking	
Winch Handle.....	222
SpeedGrip.....	222-223
Standard	222
Megayacht	210-213
All-Chrome	213
Aluminum	210, 213
Bronze.....	212-213
Plain-Top	213
Powered.....	210-213
Self-Tailing.....	210-213
Stainless Steel	211, 213
Pedestals/Pedestal Accessories 220-221	
Disconnects	221
Drive Components	221
Drive Shafts	221
Gear Boxes	221
Pedestals	220
Spinnaker Retrieval System	221
Support Shafts	221
Universal Joints.....	221
Performa	202-205
Plain-Top	204
Powered.....	205-206
Quattro.....	204
Self-Tailing.....	202-205
Plain-Top.....	197-198, 204, 212-213
Powered	195 199-201,
..... 203, 205-213, 224-229	
Captive Reel Winches.....	225-230
Circuit Breakers.....	206
CLR Mooring Winches	208-209
Control Boxes.....	206
Electric	195 199-201, 203, 204-213
Hydraulic.....	195, 199, 203, 205, 210-213
Megayacht.....	210-213
Performa	202-205
Racing.....	203, 205, 215-217

Radial Line.....	195, 199-201
Electric.....	195, 199-201
Hydraulic	195, 199
Rewind	201
UniPower	200
Reel Winches.....	224-228
Switches.....	206-207
Quattro.....	204
Racing	202-205, 214-218
Radial Line.....	194-200
Aluminum	196, 200-201
Bronze.....	198, 198-199
Chrome	196-197, 198-199
Plain-Top	197-198
Powered	195, 199-201
Electric.....	195, 199-202
Hydraulic	195, 199
Rewind	201
UniPower	200
Single-Speed Self-Tailing ..	196-198, 200
Three-Speed Self-Tailing	197-190
Two-Speed Self-Tailing.....	196-199, 201
White.....	197, 200-201
Reel Winches, Electric/Hydraulic	225-230
Self-Tailing Winches	194-205, 210-218
Single-Speed Winches	196-199, 200, 204
SnubbAir.....	193
SpeedGrip Winch Handles	221-222
Three-Speed Winches	196-199,
.....	204-205, 210-217
Two-Speed Winches	194-199,
.....	204-205, 210-215, 217

X

X-Treme Angle Fairleads	70-72
-------------------------------	-------



Index

Part No.	Page No.	Part No.	Page No.	Part No.	Page No.	Part No.	Page No.
001	38	168	36	283	71, 72	374.6	102
010	74	169	36	285	75	374.12	102
046	37	170	38	286	125	375	71, 72
047	38	173	102	287	37	376	33
061	74, 191	174	102	288	37	377	34
062	75	175	105	289	37	379	73
071.PAIR	74	176	275	292	34	381	20
072	84, 85	177	275, 276, 277	293	71, 72	383	39
073.PAIR	86	183	36	294	71, 72	385	39
074	86	193	38	295	71, 72	386	39
077	74	197	37	296	71, 72	391	33
082	36	201.PAIR	71, 72, 86	297	71, 72	394	75
083	36	205	73	298	71, 72	395	20
084	36	206	38	300	42	396	20
085	36	207	161, 162	301	**42	400	39
086	36	207HP	162	302	42	401	39
087	36	208	163	303	76	402	73
088	37	216	73	304	42	403	73
089	37	220	37	305	**42	404	33
093	84, 85	222	37	306	42	404HL	*33
096	37	223	37	307	76	405	33
097.PAIR	74	224	34	308	42	406	33
098	36	225	34	309	**42	407	33
099	36	226	34	310	42	408	33
100	36	227	34	311	76	409	33
106	37	228	34	312	42	412	70
108	37	229	34	313	42	415	76
109	36	230	34	314	42	416	33
111	84, 85	231	34	320	42	416HL	*33
112	84, 85	232	34	326	70	417	33
113	36	233	34	327	70	419	86
125	36	234	34	332	39	421	33
126	36	235	34	339	75	424	71, 72
127	36	237	75	340	20	425	71, 72
128	36	238	73	341	20	431	39
129	36	239	73	342	20	432	33
130	36	240	73	343	20	433	75
131	37	241	73	344	20	434	163
134	37	242	34	345	20	435	163
137.PAIR	71, 72, 86	243	34	346	20	436	163
138	84, 85	244	34	347	20	437	33
144	73	245	34	348	20	438	71, 72
145	71, 72	246.PAIR	84, 85	349	20	442	33
146	36	252	153	350	20	443	34
147	36	253	153	352	20	445.PAIR	86
150	70	254	153	353	20	446	102
160	76	263	137, 102	365	70	448	36, 62, 191
161	76	264	102	368	33	450	95
162	162	265	76	369	74	452P	95
163	163	275	125	370	74	452S	95
164	161, 162	277	76	371	20	453.9.5	95
165	163	280	70	373.6	102	453.12	95
166	36	281.PAIR	71, 72, 86	373.12	102	453.15	95
167	36	282.PAIR	71, 72, 86	374.4	102	453.18	95

*New parts
**Fasteners supplied

Index

Part No.	Page No.	Part No.	Page No.	Part No.	Page No.	Part No.	Page No.
453.24	95	661.3m	122	1555	41	1849	107,113
458	70	662	122	1556	41	1867	81
459	70	664	122	1558	86	1878	162
460	74	688	87	1559	41	1880	162
461	74	689	87	1560	41	1888.2m	126
463	84, 85	691	79	1564	41	1888.4m	126
464	161, 162	692	79	1565	41	1889	126
465	161, 162	693	79	1566	41	1947	117
466	42	694	79	1567	110	1948	117
467	33	712	79	1571	41	1949	117
468	70	714	79	1574	73	1981	57
469	70	716	79	1582	125	1984	57
470	70	724	81	1584	84, 85	1986	62
471	70	725	81	1586	41	1987	63
472	70	726	81	1598	84, 85	1988	62
473	70	727	79	1602.8	107	1989	63
474	70	754	79	1602.12	107	1990	62
475	71, 72	793	125	1603.PAIR	74	2103	84, 85
476	71, 72	884	191	1605.4	107	2104	84, 85
477	161	885	191	1605.6	107	2105	84, 85
477L	161	891	191	1606	107	2106	84, 85
478	161	944	191	1619	107, 139	2107	84, 85
478L	161	945	191	1621	107	2108	84, 85
478U	161	947	75, 191	1622	107	2109	84, 85
479	161	1113	*191	1628	120	2110	84, 85
480	161	1134	163	1629	120	2111	84, 85
481	161	1200	32	1631	109	2112	84, 85
482	161, 162	1201	32	1632	109	2115	84, 85
483	163	1202	32	1633	109	2116	84, 85
493	161	1203	32	1634	74	2117	84, 85
493L	161	1204	32	1635	120, 107	2118	84, 85
494	71, 72	1205	32	1636	120, 107	2119	84, 85
495	71, 72	1206	*32	1637	120	2122	84, 85
496	70	1207	*32	1642	109	2123	84, 85
497	70	1208	*32	1643	110	2124	84, 85
498	70	1300	193	1645	82	2125	84, 85
499	70	1301	193	1646	82	2126	84, 85
500	77	1522	107	1647	82	2127	84, 85
518	77	1522ASSY	147	1648	153	2131	84, 85
519	77	1523	107	1649	109	2132	84, 85
520	77	1526	275, 276, 277	1652	109	2133	86
547	275, 276, 277	1531	125	1654	110	2134	86
548	113	1533	76	1655	110	2135	25, 26
548ASSY	147	1534	76	1702	121	2135.RED	26
550	77	1539	77	1706.1.5m	121	2136	26
562	113	1540	41	1706.3m	121	2137	**26
577	125	1541	41	1706.3.6m	121	2138	26
603	77	1542	41	1707	121	2139	26
627	87, 90	1544	41	1708	121	2140	27
629	87, 90	1545	41	1734	79	2141	27
639	73	1546	41	1777	136, 152	2142	31
648	87, 90	1548	41	1835.2m	126	2143	31
657	77	1549	41	1835.4m	126	2144	31
661.2.1m	122	1550	41	1836	126	2145	31

*New parts
**Fasteners supplied



Index

Part No.	Page No.	Part No.	Page No.	Part No.	Page No.	Part No.	Page No.
2146	19	2606	23	2662	24	2710	100
2147	19	2608	26	2663	24	2711	100
2148	19	2609	26	2664	24	2720.600mm	102, 137
2149	19	2610	26	2665	24	2720.1m	102, 137
2150	19	2611	26	2666	24	2720.1.2m	102, 137
2151	19	2612	27	2667	24	2720.1.5m	102, 137
2152	19	2613	27	2668	24	2720.1.8m	102, 137
2153	19	2614	**26	2669	24	2720.2.1m	102, 137
2154	83	2615	23	2670	25, 26	2720.2.5m	102, 137
2155	83	2616	23	2671	26	2720.3m	102, 137
2156	22	2617	23	2672	**26	2720.3.6m	102, 137
2157	22	2618	23	2673	30	2720.6m	102, 137
2158	16	2619	27	2674	30	2721.1.2m	102
2159	19	2621	30	2675	30	2721.1.5m	102
2160	19, 25	2622	30	2676	30	2721.1.8m	102
2160.RED	19	2623	30	2677	24	2721.3.6m	102
2161	16	2624	30	2678	31	2722	102
2162	19	2625	25, 28	2679	31	2723	102
2163	21	2625.HTE	25	2680	25, 28	2724	102, 137
2165	25	2625.RED	28	2681	28	2725.1m	102
2165.HTE	25	2626	28	2682	28	2725.1.2m	102
2166	25	2626.RED	28	2683	28	2725.1.5m	102
2167	25	2627	28	2684	28	2725.1.8m	102
2168	25	2628	28	2685	29	2725.3.6m	102
2168.HTE	25	2629	29	2686	29	2726	103
2169	25	2630	29	2687	29	2726.NW	103
2170	25	2631	23	2688	31	2727	103
2171	16	2632	29	2689	31	2727.NW	103
2172	25	2633	28	2690	30	2728	103
2173	16	2634	29	2691	30	2728.NW	103
2174	25	2636	21	2692	30	2729	103
2175	25	2637	21	2693	30	2730	103
2176	25	2638	22, 110	2694	30	2731	103
2177	25	2639	22	2695	30	2732	103
2178	26	2640	22	2696	30	2733	103
2179	83	2641	22	2697	30	2734	103
2180	16	2642	22	2698	16	2734HL	103
2181	31	2643	22	2699	*21	2735	103
2182	31	2644	21	2700	101	2735.NW	103
2183	31	2645	21	2701	101	2736	103
2190	*17	2646	21	2702	101	2736.NW	103
2191	*17	2647	22	2703	101	2740	104, 106
2192	*17	2648	22	2704	101	2741	104
2193	*17	2649	21	2705	101	2742	104, 106
2195	*17	2650	21, 110	2706	100, 135	2743	104
2196	*17	2652	21	2707.600mm	100, 135	2745	120
2197	*17	2654	22	2707.1m	100, 135	2746	120
2198	*17	2655	30	2707.1.2m	100, 135	2747	105
2600	23	2656	30	2707.2m	100, 135	2748	105
2601	23	2657	30	2707.2.5m	100, 135	2749	105
2602	23	2658	30	2708	275, 277	2750	106
2603	23	2659	21	2709.1m	100	2750/2151/369	106
2604	23	2660	24	2709.1.2m	100	2751.600mm	102
2605	23	2661	24	2709.2m	100	2751.1m	102

*New parts
**Fasteners supplied

Index

Part No.	Page No.	Part No.	Page No.	Part No.	Page No.	Part No.	Page No.
2751.1.5m	102	3146	83	3236	58	3296	65
2751.2m	102	3147	83	3237	58	3296AL	65
2751.3.6m	102	3148	83	3238	57	3297	65
2752	120	3149	83	3239	57	3297AL	65
2753	103	3150	83	3240	58	3299	66
2754	103	3153	113, 141	3241	54	3300	66
2754.NW	103	3157	113	3242	54	3301	66
2755	104	3158	113	3243	54	3302	66
2756	103	3159.8	113	3244	54	3303	66
2757	103	3159.12	113	3245	55	3304	115, 116
2757.NW	103	3168	115, 116	3246	55	3355	78
2759	87, 105	3169	115, 116	3247	55	3356	78
2760	76	3170	115, 116	3248	55	3357	78
2761	84, 85	3173	115, 116	3249	58	3358	78
2762	23	3174	115, 116	3250	58	3362AL	65
2763	105	3176	113, 120	3251	57	3363AL	65
2764	105	3177	113, 120	3252	57	3366AL	65
2765	103	3178	113, 120	3253	58	3367AL	65
2766	103	3179	113, 120	3254	55	3368AL	65
2767	101	3180	120	3255	56	3369AL	65
2768	103	3188	82	3256	56	3370AL	65
2769	*103	3189	82	3257	58	3371AL	65
2801	*17	3190	117	3258	58	3372AL	65
3002	63	3192	62	3259	57	3375	78
3003	63	3197	115, 116	3260	57	3376	78
3004	63	3200.3m	124	3261	56	3377	78
3035	57	3202	83	3262	56	3378	78
3036	57	3203	83	3263	58	3379	78
3037	57	3206	87	3264	57	3380	78
3038	57	3207	87	3265	57	3381	78
3068	121	3211	55	3266	56	3382	78
3069	121	3212	115, 116	3267	56	3383	78
3071	122	3213	115, 116	3269	91	3384	78
3074	123, 124	3214	53	3270	91	3385	78
3075	123, 124	3215	53	3271	91	3386	53
3076	153	3216	53	3272	91	3387	53
3079.2m	124	3217	53	3273	91	3388	54
3079.3m	124	3218	53	3274	92	3389	*52
3080	124	3219	53	3275	92	3390	*52
3086.2m	126	3220	58	3276	92	3391	*52
3086.3m	126	3222	58	3277	92	3392	*52
3096	153	3223	58	3278	92	3393	*52
3097	82	3224	57	3279	92	3394	*52
3098	82	3225	117	3280	92	3395	*52
3099	82	3226	53	3281	92	3396	*52
3122	63	3227	53	3282	91	3500.4	113
3123	62	3228	53	3283.PAIR	91	3500.6	113
3139	83	3229	53	3284.PAIR	91	3802	136, 152
3140	83	3230	54	3287	86	3803	136, 152
3141	83	3231	54	3288	86	3804	137
3142	83	3232	54	3294	65	3805	137
3143	83	3233	54	3294AL	65	3806	137
3144	83	3234	58	3295	65	3807	137
3145	83	3235	58	3295AL	65	3808	137

*New parts
**Fasteners supplied

Index

Part No.	Page No.	Part No.	Page No.	Part No.	Page No.	Part No.	Page No.
3809	137	3861	138, 152	3930	148	6237	47
3810	137	3862	138, 152	3931	148	6238	47
3811	136, 152	3863	138, 152	3932	148	6239	47
3811.NW	136	3864	139	3933	150	6240	47
3812	136, 152	3865	139	3934	150	6241	47
3812.NW	136	3866	139	3935	150	6242	47
3813	134, 152	3867	140, 152	3936	149	6243	47
3814	134, 152	3868	140, 152	3937	149	6244	*47
3815	134, 152	3869	140, 152	3938	149	6250	47
3816	134, 152	3870	140, 152	3939	149, 150	6251	47
3817	135	3871	140, 152	3940	149, 150	6252	*47
3818	135	3872	140, 152	3941	149, 150	6260	48
3819	135	3873	140, 152	3942	149	6261	48
3820	135	3875	141	3943	149	6262	48
3821	135	3876	140, 146	3944	149	6263	48
3822	135	3877	140, 146	3945	140	6264	48
3823	135	3878.2m	137	3948	147	6265	48
3824	137	3878.6m	137	3949	147	6266	48
3825	137	3879	138	6050	62	6267	48
3826	137	3881	136, 152	6056	62	6268	48
3827	136, 152	3882	136, 152	6057	62	6269	48
3828	136, 152	3883	136, 152	6062	76	6270	48
3829	136, 152	3884	147	6063	76	6271	48
3829.NW	136	3885	147	6064	76	6272	48
3830	136, 152	3886	147	6065	62	6273	48
3830.NW	136	3887	147	6068	60	6274	48
3831	136, 152	3888	147	6069	60	6275	48
3831.NW	136	3889	136, 152	6070	60	6276	48
3833	138, 152	3890	140, 152	6071	60	6277	48
3834	138, 152	3891	140, 152	6072	60	6278	48
3835	138, 152	3892	144	6073	60	6280	49
3836	138, 152	3893	138, 152	6074	60	6290	49
3837	135	3894	146	6075	60	6291	49
3844	139	3895	146	6076	60	6292	49
3845	139	3896	146	6079	60	6293	49
3846	139	3897	146	6080	60	6294	49
3847	139	3901	136	6081	60	6295	49
3848	139	3902	136	6087	60	6296	49
3849.2m	139	3903	138	6089	60	6297	49
3849.6m	139	3904	138	6095	62	6298	49
3850	139	3905	144	6096	62	6299	49
3851	139	3906	144	6097	62	7000.9m	160
3852	138, 152	3907	138	6098	62	7000.12m	160
3852.NW	138	3908	136	6107	62	7000.15m	160
3853	141	3909	136	6220	48	7000.30	160
3854	141	3920	148	6221	49	7001.12m	160
3855	141	3921	148	6222	48	7001.16m	160
3856	138, 152	3922	148	6230	47	7001.20m	160
3856.NW	152	3923	148	6231	47	7001.30	160
3857	138, 152	3924	148	6232	47	7002.16m	160
3858.2m	141	3925	148	6233	47	7002.20m	160
3858.6m	141	3926	148	6234	47	7002.24m	160
3859	138, 152	3928	150	6235	47	7002.30	160
3860	138, 152	3929	148	6236	47	7003.24m	160

*New parts
**Fasteners supplied

Index

Part No.	Page No.	Part No.	Page No.	Part No.	Page No.	Part No.	Page No.
7003.28m	160	7353.10.22m	169	7413.10	179, 184	7428 -40	177, 179, 188
7006	160, 191	7353.10.26m	169	7413.11 3/4	183	7429 -48	177, 179, 188, 189
7100.24	93	7353.10BASE	170	7413.11 7/8	183	7430	191
7100.30	93	7353.20	169	7413.15	188, 190	7431	191
7100.33	93	7353.21	169	7413.20 3/4	173, 177, 179	7500	156
7100.36	93	7353.22	169, 170	7413.20 7/8	173, 177, 179	7501	156
7100.42	93	7353.23	170	7413.25 3/4	188	7502	156
7100.48	93	7353.24	170	7413.25 7/8	188	7503	156
7101	93	7353.26	169	7413.30	179, 183, 184, 188, 190	7504	156
7102	93	7353.27	169	7413.31	179, 183, 188	7505	156
7301	191	7353.28	169	7414.10	179, 184	7506	156
7302	191	7353.37	169	7414.15L	188, 190	7507	156
7303	191	7353.38	169	7414.15S	188, 190	7508	156
7304	191	7353.39	169	7414.20 7/8	173, 179	7509	156
7311.20 1/2	173, 176, 178	7355	167, 185	7414.20 1	173, 179	7510	156
7311.20 5/8	173, 176, 178	7356	167, 185	7414.20 1 1/8	173, 179	7510.10	176, 184
7311.21 1/2	173, 176, 178	7357	167, 168	7414.25 7/8	188	7510.30	176, 184
7311.21 5/8	173, 176, 178	7358	167, 168	7414.25 1	188	7510.31	176
7312.20 5/8	173, 177, 179	7359	185	7414.25 1 1/8	188	7511	156
7312.20 3/4	173, 177, 179	7360	185	7414.30	179, 184, 188, 190	7511.10	176, 184
7312.21 5/8	173, 177, 179	7361.10	168	7414.31	179	7511.30	176, 184
7312.21 3/4	173, 177, 179	7362.10	168	7414.31L	188	7511.31	176
7313.21 3/4	173, 177, 179	7363.10	169	7414.31S	188	7512.10	177, 184
7313.21 7/8	173, 177, 179	7367	169	7415.15L	189, 190	7512.30	177, 184
7351.10.16m	167	7371	167, 168	7415.15M	189, 190	7512.31	177
7351.10.18m	167	7371.SPOOL	167, 168	7415.15S	189, 190	7513.10	177, 184
7351.10.20m	167	7372	167, 168	7415.25 1 1/8	189	7513.20 1	173, 177
7351.10BASE	170	7372.SPOOL	167, 168	7415.25 1 1/4	189	7513.20 1 1/8	173, 177
7351.20	168	7373	169	7415.25 X X/X	189	7513.21 1	173, 177
7351.21	167, 168	7373.SPOOL	169	7415.30	189, 190	7513.21 1 1/8	173, 177
7351.22	167, 170	7401	185	7415.31L	189	7513.30	177, 184
7351.23	170	7402	185	7415.31M	189	7513.31	177
7351.24	170	7403	185	7415.31S	189	7875	171
7351.26	167	7404	185	7416.15L	189, 190	7880	171
7351.27	168	7405	185	7416.15M	189, 190	7881	171
7351.28	167, 168	7407	185	7416.15S	189, 190	9000	80
7351.37	167, 168	7408	191	7416.25 1 1/4	189	9001	80
7351.38	168	7410.10	178, 184	7416.25 1 3/8	189	9002	80
7351.39	167	7410.11	182	7416.25 1 9/16	189	9003	80
7352.10.20m	167	7410.20 5/16	173, 176, 178	7416.25 X X/X	189	9005	80
7352.10.23m	167	7410.20 3/8	173, 176, 178	7416.30	189, 190	9006	80
7352.10.25m	167	7410.20 7/16	173, 176, 178	7416.31L	189	9007	80
7352.10BASE	170	7410.30	178, 182, 184	7416.31M	189	9008	80
7352.20	168	7410.31	178, 182	7416.31S	189	9050	84, 85
7352.21	167, 168	7411.10	178, 184	741X.25 X/X	173	9051	73
7352.22	167, 170	7411.11 1/2	182	741X.26 X/X	173	9052	73
7352.23	170	7411.20 1/2	173, 176, 178	7420 -4	176, 178	9060	89
7352.24	170	7411.30	178, 182, 184	7421 -6	176, 178	9061	89
7352.26	167	7411.31	178, 182	7422 -8	176, 178	9062	89
7352.27	168	7412.10	179, 184	7423 -10	176, 178	9063	89
7352.28	167, 168	7412.11 5/8	183	7424 -12	176, 177, 178, 179	9064	89
7352.37	167, 168	7412.20 5/8	173, 177, 179	7425 -17	177, 179	9070.0608	89
7352.38	168	7412.30	179, 183, 184	7426 -22	177, 179, 188	9070.0810	89
7352.39	167	7412.31	179, 183	7427 -30	177, 179, 188	9070.1013	89

*New parts
**Fasteners supplied



Index

Part No.	Page No.	Part No.	Page No.	Part No.	Page No.	Part No.	Page No.
9071.0810	89	G272B	111, 112	HC8147	147	HC9597	145
9071.1013	89	G273B	111, 112	HC8148	147	HC9639	93
9071.1318	89	G273B.HL	111, 112	HC8149	147	HC9702	145
9071.1828	89	G274B	111, 112	HC8150	147	HC9703	145
9072.1013	89	G274B.HL	111, 112	HC8207	90	HC9704	145
9072.1318	89	G276S	111, 112	HC8220	147	HC9733	93
9072.1828	89	G276S.HL	111, 112	HC8221	147	HC9953	93
9072.2848	89	G321B.HL	119	HC8222	147	HC9985	61
9072.PADEYE	89	G322B.HL	119	HC8224	90	HC9986	61
9073.1013	89	G323B	119	HC8226	147	HC9987	61
9073.1318	89	G324B	119	HC8227	147	HC9990	61
9073.1828	89	G326S	119	HC8230	145	HC10041	61
9073.2848	89	G326S.HL	119	HC8537	144	HC10060	147
9073.PADEYE	89	G2227B	106	HC8537HL	144	HC10066	121
9074.1013	89	G2227B.NW	106	HC8631	61	HC10417	145
9074.1318	89	G2247B	106	HC8633	61	HC11662	147
9074.1828	89	G2727B	111, 112	HC8635	61	HC11663	147
9074.2848	89	G2737B	111, 112	HC8639	61	HSB534	39
9074.PADEYE	89	G2737B.HL	111, 112	HC8640	61	HSB538	73
9075.1013	89	G2747B	111, 112	HC8657	61	IN1642	129
9075.1318	89	G2747B.NW	112	HC8667	61	IN1642.CLEAR	128, 129
9075.1828	89	G2747B.HL	111, 112	HC8670	61	IN1643.3m	129
9075.2848	89	G3237B	119	HC8673	61	IN1643.3m.CLR	128, 129
9075.PADEYE	89	G3247B	119	HC8674	61	IN1643.3.6m	129
9300	*92	G3247B.NW	119	HC8675	61	IN1643.3.6m.CLR	128, 129
9301	*92	GT256S	127	HC8798	145	IN1643.6m	129
9302	*92	GT326S	127	HC8799	145	IN1643.6m.CLR	128, 129
9303	*92	HC6107	90	HC8800	145	IN1649	128, 129
9304	*92	HC7224	90	HC8811	145	IN1650.3m	129
9305	*92	HC7316	146	HC8879	147, 150	IN1650.3m.CLR	128, 129
E2200	102	HC7322	146	HC8880	147, 150	IN1650.3.6m	129
E2230	104	HC7324	146	HC8918	145	IN1650.3.6m.CLR	128, 129
E2250	104	HC7325	146	HC8919	145	IN1651	128, 129
E2700	107, 139	HC7327	90	HC8921	145	IN9561	129
E2730	109, 112	HC7340	90	HC8932	61	IN9561.CLEAR	128, 129
E2750	109, 112	HC7343	90	HC9045	146	IN9606	129
E2750HB	109	HC7382	147	HC9046	146	IN9606.CLEAR	128, 129
E2756	109	HC7388	90	HC9076	61	IN10567	129
E3200	113, 124, 141	HC7389	90	HC9077	61	IN10567.CLEAR	128, 129
E3230	115, 116	HC7391	147, 150	HC9078	61	Marine Grip	130
E3230.HL	115, 116	HC7403	90	HC9081	61	R27.1m	107, 139
E3250	115, 116	HC7466	147, 150	HC9082	61	R27.1mHDP	107, 139
E3250.HL	115, 116	HC7493	145	HC9083	61	R27.1.2m	107, 139
E3250HB	115, 116	HC7827	145	HC9086	61	R27.1.5m	107, 139
E3256	115, 116	HC7852	90	HC9087	61	R27.1.8m	107, 139
FW250EA12H	59	HC7904HL	144	HC9088	61	R27.2m	107, 139
FW250EA24H	59	HC7905	144	HC9091	61	R27.2.5m	107, 139
FW250HA	59	HC7905HL	144	HC9092	61	R27.3m	107, 139
FW500EA12H	59	HC7906	144	HC9093	61	R27.3.6m	107, 139
FW500EA24H	59	HC7906HL	144	HC9106	145	R27.6m	107, 139
FW500HA	59	HC8076	146	HC9107	145	R27HB.1m	107
G222B	106	HC8098	146	HC9108	145	R27HB.1.5m	107
G224B	106	HC8099	146	HC9503	93	R27HB.1.8m	107
G226S	106	HC8125	146	HC9504	93	R27HB.2.5m	107

*New parts
**Fasteners supplied

Index

Part No.	Page No.	Part No.	Page No.	Part No.	Page No.	Part No.	Page No.
R27HB.3.6m.....	107	VM33444.....	154	20STC.....	196	80.3STEP.....	205
R32.1m.....	113, 141	VM44656.....	154	20STCCC.....	197	Radial	
R32.1mHDP.....	113, 141	VM54860.....	154	35.2STA.....	196	40RW.....	201
R32.1.5m.....	113, 141	VM66274.....	154	35.2STBBB.....	198	46RW.....	201
R32.1.8m.....	113, 141	VM76274.....	154	35.2STC.....	196	60RW.....	201
R32.2.1m.....	113, 141	VM87385.....	154	35.2STCCC.....	197	35.2STE.....	199
R32.2.4m.....	113, 141	VMB12.....	157	40.2STA.....	196	40.2STE.....	199
R32.3m.....	113, 141	VMB34.....	157	40.2STBBB.....	198	46.2STE.....	199
R32.3.6m.....	113, 141	VMB56.....	157	40.2STC.....	196	50.2STE.....	199
R32.6m.....	113, 141	VMBF12.....	157	40.2STCCC.....	197	60.2STE.....	199
R32HB.1.5m.....	113	VMBF34.....	157	46.2STA.....	196	60.3STE.....	199
R32HB.1.8m.....	113	VMBF56.....	157	46.2STBBB.....	198	70.2STE.....	199
R32HB.2.5m.....	113	VMM12.....	157	46.2STC.....	196	70.3STE.....	199
R32HB.3.6m.....	113	VMM34.....	157	46.2STCCC.....	197	80.2STE.....	*199
R32HB.4.5m.....	113	VMM56.....	157	50.2STA.....	196	80.3STE.....	*199
T2701B.....	108	VMP2.....	157	50.2STBBB.....	198	500UPW.....	200
T2701B.NW.....	108	VMP3.....	157	50.2STC.....	196	900UPW.....	200
T2701B.HL.....	108	STANDARD WINCHES		50.2STCCC.....	197	ELECTRIC COMPONENTS	
T2701B.HL.NW.....	108	Performa		60.2STA.....	196	B40PDR.....	205
T2703B.....	108	20STP.....	204	60.2STBBB.....	198	B46PDR.....	205
T2703B.HL.....	108	20.2PTBBB.....	198	60.2STC.....	196	B50PDR.....	205
T2704B.HL.....	108	20.2PTCCC.....	197	60.2STCCC.....	197	B60PDR.....	205
T2705B.....	108	20.2PTP.....	204	60.3STA.....	196	B60.3PDR.....	205
T2705B.HL.....	108	30.2STP.....	204	60.3STBBB.....	198	B70PDR.....	205
T2721B.....	108	35.2PTBBB.....	198	60.3STC.....	196	B70.3PDR.....	205
T2721B.HL.....	108	35.2PTCCC.....	197	60.3STCCC.....	197	B80PDR.....	205
T2731B.....	108	35.2PTP.....	204	70.2STA.....	196	B80.3PDR.....	205
T2731B.HL.....	108	35.2STP.....	204	70.2STBBB.....	198	BRS102/P.....	206
T2741B.....	108	40STQP.....	204	70.2STC.....	196	BRS102/S.....	206
T2741B.HL.....	108	40.2PTBBB.....	198	70.2STCCC.....	197	BRS104/P.....	206
T2751B.....	108	40.2PTCCC.....	197	70.3STA.....	196	DSDBK1-ND.....	207
T27KIT.....	110	40.2PTP.....	204	70.3STBBB.....	198	DSDBK2-ND.....	207
T3201B.....	114	40.2STP.....	204	70.3STC.....	196	DSDBK3-ND.....	207
T3201B.NW.....	114	46STQP.....	204	70.3STCCC.....	197	DSDSS1-ND.....	207
T3201B.HL.....	114	46.2PTBBB.....	198	80.2STA.....	196	DSDSS2-ND.....	207
T3201B.HL.NW.....	114	46.2PTCCC.....	197	80.2STC.....	196	DSDSS3-ND.....	207
T3203B.....	114	46.2PTP.....	204	80.2STCCC.....	*197	DSSBK4-ND.....	207
T3203B.HL.....	114	46.2STP.....	204	80.3STA.....	196	DSSSS4-ND.....	207
T3204B.....	113, 114	50.2PTBBB.....	198	80.3STC.....	196	HCP1717.....	206
T3204B.HL.....	114	50.2PTCCC.....	197	Custom/Racing Winches.....	210, 211, 212, 213	HCP1718.....	206
T3205B.....	114	50.2PTP.....	204	B6A.....	204	HCP1719.....	206
T3205B.HL.....	114	50.2STP.....	204	B8A.....	204	HCP1720.....	206
T3209B.....	113, 114	50.3STP.....	204	ELECTRIC WINCHES		Dual Function Control Boxes ...	206
T3209B.HL.....	114	55.3STP.....	*204	Performa		HYDRAULIC WINCHES	
T3221B.....	114	60.2STP.....	204	35.2STEP.....	*205	Performa	
T3221B.HL.....	114	60.3STP.....	204	40.2STEP.....	205	46.2STHP.....	205
T3231B.....	114	70.2STP.....	204	46.2STEP.....	205	50.2STHP.....	205
T3231B.HL.....	114	70.3STP.....	204	50.2STEP.....	205	60.2STHP.....	205
T3241B.....	114	80.2STP.....	204	60.2STEP.....	205	60.3STHP.....	205
T3241B.HL.....	114	80.3STP.....	204	60.3STEP.....	205	70.2STHP.....	205
T32KIT.....	110, 117	Radial		70.2STEP.....	205	70.3STHP.....	205
T32KIT.HL.....	117	15STA.....	196	70.3STEP.....	205	80.2STHP.....	205
VM13240.....	154	20STA.....	196	80.2STEP.....	205	80.3STHP.....	205
VM24353.....	154	20STBBB.....	198				

*New parts
**Fasteners supplied

Index

Part No.	Page No.	Part No.	Page No.	Part No.	Page No.	Part No.	Page No.
Radial		HYDRAULICS		Valve Assemblies		HYZD6-3 250	
46.2STH	199	Boom Vangs		HYA1000XPGB2JL	244	HYZD6-4	250
50.2STH	199	HYCV	241	HYA1000XPGBXJ	244	HYZD6-6	250
60.2STH	199	Custom Mega G Vangs	241	HYA2000XPGB2JL	244	Valves	
60.3STH	199	Compact Control Panel		HYA2000XPGBXJ	244	HYVDPBF	244
70.2STH	199	HYACXPXB1J	246	HYA3000XPGB2JL	244	HYVDSPF	244
70.3STH	199	Cylinders		HYA3000XPGBXJ	244	CUSTOM PRODUCTS	
80.2STH	199	HYCL	237	HYA4000XPGB2JL	244	C4219	127
80.3STH	199	HYCP	238	HYA4000XPGBXJ	244	C4579	79
AIR WINCHES *219		HYCS	236, 242	MVP Panels		C5160	122
CAPTIVE AIR WINCHES *226		Cylinder Blocks and Toggles		HYAMXPGB1J	245	C5231	121
CAPTIVE REEL WINCHES 227, 228, 229, 230		HYCBB16	239	HYAMXPGB2J	245	C5280	121
CARBON FIBER WINCHES 214, 215, 216, 217		HYCBB19	239	HYAMXPGC1J	245	C5754	127
CLR MOORING WINCHES 209		HYCBB22	239	HYAMXPGC2J	245	C5834	127
CLR2500	209	HYCBD11	239	HYAMXPGF1J	245	C5900	121
CLR4000	209	HYCBD13	239	HYAMXPGF2J	245	C6138	121
CLR8000	209	HYCBD16	239	HYAMXPGS1J	245	C6361	122
CLR12000	209	HYCBD19	239	HYAMXPGS2J	245	C6762	121
WINCH ACCESSORIES		HYCBD22	239	HYASXPGB1J	245	C6779	90
Service Kits		HYCBS11	239	HYASXPGB2J	245	C6795	119
BK4512	224	HYCBS13	239	HYASXPGC1J	245	C6924	124
BK4513	224	HYCBS16	239	HYASXPGC2J	245	C7513	121
BK4514	224	HYCBS19	239	HYASXPGF1J	245	C7842	79
BK4515	224	HYCBS22	239	HYASXPGF2J	245	C8322	63
BK4516	224	HYHTEJS11	239	HYASXPGS1J	245	C8378	123, 124
BK4517	224	HYHTEJS13	239	HYASXPGS2J	245	C8583	122
BK4518	224	HYHTEJS16	239	Pressure Hoses		C8624	63
BK4519	224	HYHTEJS19	239	HYZHP520N-3	250	C8728	123, 124
BK4521	224	HYHTEJS22	239	HYZHP520N-4	250	C8774	127
Winch Handles		HYHTEJS25	239	HYZHP520N-6	250	C8914	123, 124
B8AL	223	HYHTEJS29	239	HYZHT7212-6	250	C8955	123, 124
B8AP	223	HYHTEJS32	239	Pumps		C8990	124
B8ASG	223	HYHTEJS35	239	HYPM1	247	C8997	90
B8ASGLP	223	HYHTEJS38	239	HYPM2	247	C9043	127
B8BL	223	HYHTEJS44	239	HYPM3MP	247	C9057	90
B8CL	223	Hydraulic Accessories		HYPMH6600	248	C9064	90
B8CSG	223	HYFAP03S	249	HYPMH6800	248	C9153	90
B10ADL	223	HYFAP03TF	249	HYPMHC800	248	C9240	90
B10AL	223	HYFAP03TM	249	HYPMHC800S	248	C9242	127
B10AP	223	HYFAT40	249	HYPMHC1000	248	C9340	150
B10ASG	223	HYFAT40J6	249	HYPMHC1000S	248	C9341	150
B10BL	223	HYZSCJF4H3	250	HYPR262	247	C9342	150
B10CL	223	HYZSCJF4H4	250	HYPR314	247	C9368	122
B10CSG	223	HYZSCJF6H6	250	Pump Panels		C9374	90
B10HOT	222	HYZSSJF4H3	250	HYAPM1BJ	244	C9460	123, 124
		HYZSSJF4H4	250	HYAPM2BJ	244	C9492	150
		HYZSSJF6H6	250	Reservoirs		C9493	150
		Hydraulic Oil		HYRPC02	248	C9494	150
		HYOIL22QUART	249	HYRPC04	248	C9511	90
		Integral Backstay Adjusters		HYRPC08	248	C9512	90
		HCI006BCC	234	HYRPC10	248	C9527	90
		HCI010BCC	234	HYRVP02	248	C9541	124
		HCI012BCC	234	HYRVP04	248	C9577	127
		HCI017BCC	234	Through-Deck Gland		C9584	90

*New parts
**Fasteners supplied

Index

Part No.	Page No.	Part No.	Page No.
C9642.....	123, 124	C14823.....	78
C9679.....	124	C14840.....	136
C9701.....	123, 124	C14843.....	78
C9758.....	90	C14943.....	123, 124
C9760.....	90	C14949.....	122
C9761.....	90	C14951.....	65
C9775.....	90	C14967.....	121
C9969.....	123, 124	C15012.....	121
C10051.....	119	C15086.....	122
C10063.....	90	C15190.....	121
C10232.....	119	C15203.....	65
C10413.....	124	C15229.....	91
C10419.....	150	C15258.....	123, 124
C10434.....	121	C15265.....	124
C10539.....	150	C15267.....	91
C10598.....	123, 124		
C10747.....	123, 124		
C10768.....	90		
C10879.....	139		
C10901.....	127		
C10948.....	127		
C11003.....	90		
C11173.....	90		
C11177.....	90		
C11334.....	90		
C11349.....	124		
C11432.....	123, 124		
C12236.....	61		
C12237.....	61		
C12238.....	61		
C12239.....	61		
C12242.....	61		
C12243.....	61		
C12244.....	61		
C12245.....	61		
C12343.....	90		
C12369.....	121		
C12728.....	124		
C12792.....	121		
C12814.....	90		
C13260.....	127		
C13285.....	123, 124		
C13559.....	124		
C13771.....	61		
C13849.....	121		
C13911.....	61		
C14040.....	61		
C14196.....	61		
C14207.....	61		
C14457.....	61		
C14584.....	61		
C14640.....	123, 124		
C14696.....	61		
C14730.....	65		

*New parts
**Fasteners supplied



CORPORATE HEADQUARTERS:

HARKEN INC., USA

One Harken Way
N15W24983 Bluemound Road
Pewaukee, Wisconsin 53072 USA
T: (262) 691-3320
F: (262) 701-5780
E: harken@harken.com
www.harken.com

ISO 9001:2015 Certified



USA SALES OFFICES:

Harken East (Trade Only)
19 John Clarke Rd.
Middletown, RI 02842
T: (401) 849-8278
F: (401) 841-5070

Harken Southeast (Trade Only)
Peter Doyle
T: (716) 445-7368
E: peter.doyle@harken.com

Harken West
Allan Johnson
T: (206) 919-5317
E: allan.johnson@harken.com

HARKEN ITALY S.P.A.

Via Marco Biagi, 14
22070 Limido Comasco (CO) Italy
T: (39) 031.3523511
F: (39) 031.3520033
E: info@harken.it
www.harken.it

ISO 9001:2015 Certified



DISTRIBUTORS

Argentina

Harken Argentina
Del Arca 59
1646 San Fernando,
Buenos Aires Argentina
T: +54-11-4725-0200
F: +54-11-4746-7561
E: info@harken.com.ar

Austria

Peter Frisch GmbH
Isar-Ring 11,
D-80805 München, Germany
T: (49) 89-365075
F: (49) 89-365078
E: info@frisch.de
www.frisch.de

Brazil

Harken Brazil Av. Princesa Isabel,
2095, Barra Velha
CEP 11630-000, Ilhabela, SP, Brazil
T: +55 12 3895 8754
F: +55 12 3895-8779
E: brasil@harken.com.br
www.harken.com.br

Canada

Western Marine Company
1494 Powell Street
Vancouver, BC, Canada V5L 5B5
T: (604) 253-7721
T: (800) 663-0600
F: (604) 253-2656
E: sales@westernmarine.com
www.westernmarine.com

Transat Marine
Division of Western Marine
70 Ellis Drive, Unit #1
Barrie, ON L4N 8Z3, Canada
T: (705) 721-0143
T: (800) 565-9561
F: (705) 721-0747
E: info@transatmarine.com
www.transatmarine.com

Caribbean

Budget Marine Antigua
Jolly Harbour Boatyard
Bolans, Antigua
T: 268-462-8753
F: 268-462-7727
E: antigua@budgetmarine.com

Budget Marine Antigua
Compton Building Dockyard Drive
English Harbour, St Paul's, Antigua
T: 268 562 8443
F: 268 462 7727
E: antigua@budgetmarine.com

Budget Marine Antigua
North Sound Marina
Crabbs Peninsula, Antigua
T: 268-562-8753
E: antigua@budgetmarine.com

Budget Marine Aruba
Balashi 75-B, P.O. Box 162
Oranjestad, Aruba
T: 297-585-3796
F: 297-585-3798
E: aruba@budgetmarine.com

Budget Marine Bonaire
Kaya Neerlandia 21 Kralendijk,
Bonaire Dutch Caribbean
T: 599-717-3710 F: 599-717-3523
E: bonaire@budgetmarine.com

Budget Marine Curaçao
Caracasbaaiweg 202
Curaçao, Dutch Caribbean
T: 5999-462-7733 F: 5999-462-7755
E: curacao@budgetmarine.com

Budget Marine Grenada
Spice Isle Marina, True Blue Bay
St. George Grenada
T: 473-439-1983 F: 473-439-2037
E: grenada@budgetmarine.com

Budget Marine St. Maarten
Waterfront Road 25B
Cole Bay, St. Maarten
Dutch Caribbean T: 721-544-3134
E: stmaarten@budgetmarine.com

Budget Marine St. Thomas
6198 Estate Frydenhoj
St. Thomas, VI 00802
U.S. Virgin Islands T: 340-779-2219
E: stthomas@budgetmarine.com

Budget Marine Tortola Nanny Cay
Resort Tortola, British Virgin Islands
T: 284-494-6588 F: 284-494-0792
E: tortola@budgetmarine.com

Budget Marine Trinidad
Western Main Road
Chaguaramas Trinidad & Tobago
T: 868-634-2006
F: 868-634-4382
E: trinidad@budgetmarine.com

Richardson's Rigging Services
Box 97, Waterfront Drive
Tortola, British Virgin Islands
T: 284 494-2739 T: 284-499-4774
E: info@richardsonsrigging.com

Czech Republic

Harken Polska Sp. z o.o.
ul. Przasnyska 6A
01-756 Warszawa Poland
T: +48 22 561 93 93
E: polska@harken.pl
www.harken.pl

Chile

Windmade Chile
Las Tranqueras 117, Of. 607B
Las Condes, Santiago, Chile
T: +562 29807079
E: sales@windmade.cl
www.windmade.cl

China

Sunrise Marineware Limited
12th Floor, Building 2,
Baiwang Mansion,
Shahe West Road,
Nanshan District,
Shenzhen P.R.China
T: 86-755 86650101
F: 86-755 86593878
E: sales@sunrisemw.com
www.sunrisemw.com

SHANGHAI Far East FRP Boat
Co., Ltd. Room 605, Building 5
No. 898 Xiuwen Rd.
Shanghai, China 201199
T: +86 21-67 28 59 77
F: +86 21-67 28 59 76
www.fareastboats.com

Croatia

Sailing Point d.o.o.
Obala 103,6320 Portoroz Slovenia
T: +386-5-6778125
Mobile: +386 41 418899
E: info@sailing-point.si
www.sailing-point.si

Cyprus

Ocean Marine Equipment, Ltd.
245 A&B Saint Andrews
Street, (3035),
P.O.Box 51370, (3504),
Limassol, Cyprus
T: +357 25369731 F: +357 25352976
E: info@oceanmarine.com.cy
www.oceanmarine.com.cy

Denmark

Columbus Marine A/S
Egegaardsvej 8
4621 Gadstrup Denmark
T: +45 4619 1166
E: columbus@columbus-marine.dk
www.columbus-marine.dk

Estonia

Sail Tech Oy
Veneentkijäntie 10, FIN-00210
Helsinki, Finland
T: (358) 9 682 4950
E: info@sailtech.fi www.sailtech.fi

Finland

Sail Tech Oy
Veneentkijäntie 10, FIN-00210
Helsinki, Finland
T: (358) 9 682 4950
E: info@sailtech.fi
www.sailtech.fi

Germany

Peter Frisch GmbH
Isar-Ring 11,
D-80805 München, Germany
T: (49) 89-365075 F: (49) 89-365078
E: info@frisch.de www.frisch.de

Gibraltar

M. Sheppard & Co. Ltd.
Waterport, Gibraltar
T: 350 200 75148 F: 350 200 42535
E: retail@sheppard.gi
www.sheppard.gi

Greece

Tecrep Marine S.A.
Akti Moutsopolou 36
Piraeus 185 36, Greece
T: 30 210 4521647
F: 30 210 4184280
E: info@tecrepmarine.gr
www.tecrepmarine.gr



Harken Australia Pty. Ltd.
1B Green Street
Brookvale, N.S.W., 2100, Australia
T: (61) 2-8978-8666
E: sales@harken.com.au
www.harken.com.au



Harken France
ZA Port des Minimes, BP 3064
17032 La Rochelle Cedex 1 France
T: (33) 05.46.44.51.20
F: (33) 05.46.44.25.70
E: info@harken.fr
www.harken.fr



Harken UK, Ltd.
Bearing House,
Ampress Lane, Lymington,
Hampshire S041 8LW, England
T: (44) 01590-689122
F: (44) 01590-610274
E: sales@harken.co.uk
www.harken.co.uk



Holland/Belgium
On Deck B.V.
Leimuiderdijk 478a
2156 MX Weteringbrug
The Netherlands
T: 31 71 331 3366
F: 31 71 331 3387
E: allhands@on-deck.nl
www.on-deck.nl



Harken Polska Sp. z o.o.
ul. Przasnyska 6A
01-756 Warszawa, Poland
T: +48 22 561 93 90
E: polska@harken.pl
www.harken.pl



Sweden
Harken Sweden AB Brandstore
Västmannagatan 81b
113 26 Stockholm, Sweden
T: (46) 08 222200
F: (46) 0303 61876
E: harken@harken.se
www.harken.se



Harken New Zealand, Ltd.
129 Westhaven Dr.
Westhaven, Auckland, 1010,
New Zealand
T: (64) 9-303-3744 F: (64) 9-307-7987
E: info@harken.co.nz
www.harken.co.nz
www.fostersshipchandlery.co.nz

Hong Kong
Sunrise Marineware Limited
Unit 1,2/F, Hing Wah Industrial
Building, 18 Hi Yip Street,
Yuen Long NT, Hong Kong
T: +852 6942 7682
E: sales@sunrisemw.com
www.sunrisemw.com

Hungary
Peter Frisch GmbH
Isar-Ring 11, D-80805
München, Germany
T: (49) 89-365075
F: (49) 89-365078
E: info@frisch.de
www.frisch.de

Israel
Yamit Y.S.B. Inc.
Marina Tel-Aviv, P.O.B. 6158
Tel-Aviv 61061, Israel
T: (972) 3-527 1777
F: (972) 3-527 1031
E: office@yamitysb.co.il
www.yamitysb.co.il

Japan
Harken Japan Ltd.
2-42 Nishinomiya Hama
Nishinomiya City Hyogo Pref.,
Japan 662-0933
T: (81) 798-22-2520
F: (81) 798-22-2521
E: info@harken.jp
www.harken.jp

Korea
Marine Service Korea Co.,Ltd.
#537 Sunplaza Officetel
1443 Woo-dong Haeundae-gu,
Busan, Korea 48092
T: +82-51-744-7882
F: +82-51-744-7883
E: totalmarine_korea@naver.com
www.servicemarine.co.kr

Latvia
Regate
7A Matrozhu Str. Kipsala,
Riga, LV-1048, Latvia
T: +371 24873486
E: regate@regate.lv
www.harken.lv

Lithuania
Regate
7A Matrozhu Str. Kipsala,
Riga, LV-1048, Latvia
T: +371 24873486
E: regate@regate.lv
www.harken.lv

Malaysia
Harken Australia
1B Green Street Brookvale,
N.S.W., 2100, Australia
T: (61) 2-8978-8666
E: info@harken.com.au
www.harken.com.au

Malta
Harken Italy
Via Marco Biagi, 14
22070 Limido Comasco (CO) Italy
T: (39) 031.3523511
F: (39) 031.3520031
E: info@harken.it
www.harken.it

Norway
Harken Sweden AB
Hovdan Poly A/S
Stubberudveien 10
Oslo N-0614, Norway
T: (47) 2314 1260
F: (47) 2314 1261
E: hovdan.poly@online.no

Portugal
Equipyacht S.L.
Paseo Joan de Borbó s/n
Moll de Llevant – Nave Sur 4ª Planta
Port de Barcelona
08039 Barcelona, Spain
T: (34) 932 219 219
F: (34) 932 219 578
E: equipyacht@equipyacht.com
www.equipyacht.com

Singapore
Marintech Marketing (S) Pte. Ltd.
101 Kitchener Road, #02-14
Jalan Besar Plaza
Singapore 208511
T: (65) 62988171
F: (65) 62923869
E: marintech@pacific.net.sg
www.marintech.sg

Slovakia
Harken Polska Sp. z o.o.
ul. Przasnyska 6A
01-756 Warszawa Poland
T: +48 22 561 93 93
E: polska@harken.pl
www.harken.pl

Slovenia
Sailing Point d.o.o.
Obala 103,
6320 Portoroz, Slovenia
T: +386-5-6778125
Mobile: +386 41 418899
E: info@sailing-point.si
www.sailing-point.si

South Africa
Harken South Africa
22 Bolt Avenue
Montague Gardens
Cape Town, 7441 South Africa
T: +27 (0) 21 511 3244
F: +27 (0) 21 511 3249
E: info@harken.co.za
www.harken.co.za

Spain
Equipyacht S.L.
Paseo Joan de Borbó s/n
Moll de Llevant – Nave Sur 4ª Planta
Port de Barcelona
08039 Barcelona, Spain
T: +34 932 219 219
F: +34 932 219 578
E: tienda@equipyacht.com
www.equipyacht.com

Harken ProCare - Palma
Equipyacht Palma
Calle Tetuán 26
07011 - Palma de Mallorca
Illes Balears -Spain
T: +34 971 570 734
E: palma@equipyacht.com

Switzerland
Harken Swiss
Peter Frisch GmbH
Isar-Ring 11, D-80805
München, Germany
T: (49) 89-365075
F: (49) 89-365078
E: info@frisch.de
www.frisch.de

Taiwan
Mercury Marine Supply Co. Ltd.
No. 15, Chongshan Street
Siaogang District,
Kaohsiung, 812, Taiwan, R.O.C.
T: (886) 7-8133233
F: (886) 7-8133236
E: mms46654@ms16.hinet.net

Sunrise Marineware Limited
Unit 1, 2/F, Hing Wah
Industrial Building,
18 Hi Yip Street, Yuen Long NT,
Hong Kong
T: +852 6942 7682
E: sales@sunrisemw.com
www.sunrisemw.com

Thailand
Rolly Tasker Sails (Thailand) Co., Ltd.
84/2 Moo 2, Chaofa Road T. Vichit,
A. Muang Phuket 83000 Thailand
T: (66) (0) 76 521 591
F: (66) (0) 76 521 590
E: chandlery@rollytasker.com
E: masts@rollytasker.com
www.rollytasker.com

Turkey
Denpar Makina San. Ve Tic. A.S
Ozbek Sok No:1 Kavacik
Beykoz Istanbul, Turkey
T: +90 (0) 216 693 35 35
F: +90 (0) 216 693 27 27
E: info@denpar.com
www.denpar.com

Ukraine
Harken Polska Sp. z o.o.
ul. Przasnyska 6A
01-756 Warszawa, Poland
T: +48 22 561 93 93
E: polska@harken.pl
www.harken.pl

Uruguay
Harken Argentina
Del Arca 59
1646 San Fernando
Buenos Aires, Argentina
T: +54 11 4725 0200
F: +54 11 4746 7561
E: info@harken.com.ar



SMALL BOAT BLOCKS



BIG BOAT BLOCKS



COMPLEMENTARY HARDWARE



TRAVELERS & GENOA LEADS



MAINSAIL HANDLING SYSTEMS



HEADSAIL HANDLING SYSTEMS



WINCHES



HYDRAULICS



REFERENCE



INDEX

HARKEN®

BPCE/Jérémie Lecaudey



4000.2024

ENGLISH
4000.2024

harken.com
Email: harken@harken.com